

LOW INPUT CAPACITANCE MONOLITHIC DUAL N-CHANNEL JFET

FEATURES	
Ultra-Low Noise	$e_n=2.5\text{nV}/\sqrt{\text{Hz}}$ @1kHz TYP.
Low Leakage	$I_G=15\text{pA}$ TYPs.
Low Drift	$ V_{GS1-2}/T =5\mu\text{V}/^\circ\text{C}$ max.
Ultra-Low Offset Voltage	$ V_{GS1-2} =1\text{mV}$ max.
ABSOLUTE MAXIMUM RATINGS ¹	
@ 25°C (unless otherwise noted)	
Maximum Temperatures	
Storage Temperature	-55° to +150°C
Operating Junction Temperature	-55° to +150°C
Maximum Voltage and Current for Each Transistor ¹	
$-V_{GSS}$	Gate Voltage to Drain or Source 60V
$I_{G(f)}$	Gate Forward Current 50mA
Maximum Power Dissipation ²	
Device Dissipation ² @ Free Air - Total	400mW $T_A=+25^\circ\text{C}$

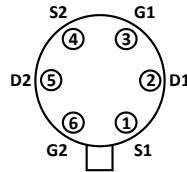

TO-71 6L
Top View

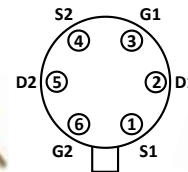

TO-78 6L
Top View

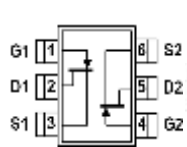

SOT-23 6L
Top View

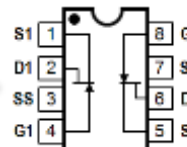

SOIC-A 8L
Top View

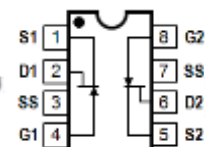

PDIP 8L
Top View

* For equivalent single version, see LSK189

Features

- Low Noise: $e_n = 2.5\text{nV}/\sqrt{\text{Hz}}$ (typ), $f = 1\text{kHz}$, NBW = 1Hz
- Very Low Common Source Input Capacitance of $C_{ISS} = 3\text{pF}$ – typ and 8pF- max
- High Slew Rate
- Low Offset/Drift Voltage
- Low Gate Leakage I_{GSS} and I_G
- High CMRR 102 dB

Benefits

- Tight Differential Voltage Match vs. Current
- Improved Op Amp Speed Settling Time Accuracy
- Minimum Input Error Trimming Error Voltage
- Lower Intermodulation Distortion

Applications

- Wideband Differential Amplifiers
- High Speed Temperature Compensated Single Ended Input Amplifier Amps
- High Speed Comparators
- Impedance Converters
- Sonobouys and Hydrophones
- Acoustic Sensors

Description

The LS844 Series is the industry's lowest input capacitance and low-noise monolithic dual N-Channel JFET. Low input capacitance substantially reduces intermodulation distortion. In addition, these dual JFETs feature tight offset voltage and low drift over temperature range, and are targeted for use in a wide range of precision instrumentation and sensor applications.

The LS844 Series is available in surface mount plastic SOIC 8L, PDIP 8L and SOT-23 6L packages. Additionally, it is offered in thru-hole metal cans; the TO-71 6L and TO-78 6L package.

For an equivalent single N-Channel version refer to the LSK189 datasheet. LS844 Series TO-71 6L and SOIC 8L are fit, form and pin compatible to the same LSK389 product.

The LS844 Series provides an increase in capabilities for a wide range of low-noise applications.

The most significant aspect of the LS844 Series is how it combines a noise level comparable with the LSK389 while having much lower gate-to-drain capacitance, 4pF versus the 25pF. The slightly higher noise of the LS844 Series, versus the LSK389, is not significant in most instances, while the much lower capacitance enables designers to produce simpler, more elegant circuit designs with fewer devices that cost less in production.

Like the Linear Systems LSK389, the LS844 Series features a unique design construction of interleaving both JFETs on the same piece of silicon to provide excellent matching and thermal tracking, as well as a low-noise profile having nearly zero popcorn noise.

Electrical Characteristics @ 25°C (unless otherwise noted)

SYMBOL	CHARACTERISTIC	LS843	LS844	LS845	UNITS	CONDITIONS
$I_{V_{GS1-2}/T}$ max.	Drift vs. Temperature	5	10	25	$\mu\text{V}/^\circ\text{C}$	$V_{DG} = 10\text{V}$ $T_A = -55^\circ\text{C}$ to $+125^\circ\text{C}$ $I_D = 500\mu\text{A}$
$I_{V_{GS1-2}}$ max.	Offset Voltage	1	5	15	mV	$V_{GS} = 10\text{V}$ $I_D = 500\mu\text{A}$

SYMBOL	CHARACTERISTIC	MIN.	TYP.	MAX.	UNITS	CONDITIONS
BV_{GSS}	Breakdown Voltage	-60	--	--	V	$V_{DS} = 0$ $I_D = -1\text{nA}$
BV_{GGO}	Gate-to-Gate Breakdown	± 60	--	--	V	$I_{GGO} = \pm 1\mu\text{A}$ $I_D = 0$ $I_S = 0$
G_{fss}	TRANSCONDUCTANCE Full Conduction	1500	--	--	μS	$V_{DS} = 15\text{V}$ $V_{GS} = 0$ $f = 1\text{kHz}$
G_{fs}	Typical Conduction	1000	1500	--	μS	$V_{DS} = 15\text{V}$ $I_D = 500\mu\text{A}$
$ G_{fs1-2}/G_{fs1} $	Mismatch	--	0.6	3	%	
I_{DSS}	DRAIN CURRENT Full Conduction	1.5	5	15	mA	$V_{DS} = 15\text{V}$ $V_{GS} = 0$
$ I_{DSS1-2}/I_{DSS} $	Mismatch at Full Conduction	--	1	5	%	
$V_{GS}(\text{off})$	GATE VOLTAGE Pinchoff Voltage	-1	--	-3.5	V	$V_{DS} = 15\text{V}$ $I_D = 1\text{nA}$
V_{GS}	Operating Range	-0.5	--	-3.5	V	$V_{DS} = 15\text{V}$ $I_D = 500\mu\text{A}$
$-I_G$	GATE CURRENT Operating	--	15	50	pA	$V_{DG} = 15\text{V}$ $I_D = 500\mu\text{A}$
$-I_G$	High Temperature	--	--	50	nA	$V_{DG} = 15\text{V}$ $I_D = 500\mu\text{A}$ $T_A = +125^\circ\text{C}$
$-I_G$	Reduced VDG	--	5	30	pA	$V_{DG} = 3\text{V}$ $I_D = 500\mu\text{A}$
$-I_{GSS}$	At Full Conduction	--	--	100	pA	$V_{GS} = 15\text{V}$ $V_{GS} = 0$
G_{OSS}	OUTPUT CONDUCTANCE Full Conduction	--	--	40	μS	$V_{DS} = 15\text{V}$ $V_{GS} = 0$
G_{OS} $ G_{OS1-2} $	Operating Differential	--	2.0	2.7	μS	$V_{DS} = 15\text{V}$ $I_D = 200\mu\text{A}$
		--	0.02	0.2	μS	

SYMBOL	CHARACTERISTIC	MIN.	TYP.	MAX.	UNITS	CONDITIONS
	COMMON MODE REJECTION					
CMRR	$-20 \log \left \frac{\Delta V_{GS1-2}}{\Delta V_{DS}} \right $	90	100	--	dB	$V_{DS} = 10 \text{ to } 20V$ $I_D = 500\mu A$
CMRR		--	85	--	dB	$V_{DS} = 5 \text{ to } 10V$ $I_D = 500\mu A$
e_n	Voltage	--	--	3.0	nV/Hz	$V_{DS} = 15V$ $I_D = 2.0mA$ $f = 1kHz$ NBW= 1Hz
e_n	Voltage	--	--	7.0	nV/Hz	$V_{DS} = 15V$ $I_D = 2.0mA$ $f = 10Hz$ NBW= 1Hz
	CAPACITANCE					
C_{ISS}	Input	--	--	8	pF	$V_{DS} = 15V$ $I_D = 500\mu A$ $f = 1mHz$
C_{RSS}	Reverse Transfer	--	--	3	pF	
C_{DD}	Drain-to-Drain	--	0.5	--	pF	$V_{DD} = 15V$ $I_D = 500\mu A$ $f = 1mHz$

Notes:

1. Absolute maximum ratings are limiting values above which serviceability may be impaired.
2. Pulse width $\leq 2ms$.
3. All MIN/TYP/MAX Limits are absolute values. Negative signs indicate electrical polarity only.
4. Derate 2.4 mW/°C above 25°C.
5. Derate 4 mW/°C above 25°C.

Information furnished by Linear Integrated Systems is believed to be accurate and reliable. However, no responsibility is assumed for its use; nor for any infringement of patents or other rights of third parties which may result from its use. No license is granted by implication or otherwise under any patent or patent rights of Linear Integrated Systems.

Typical Characteristics

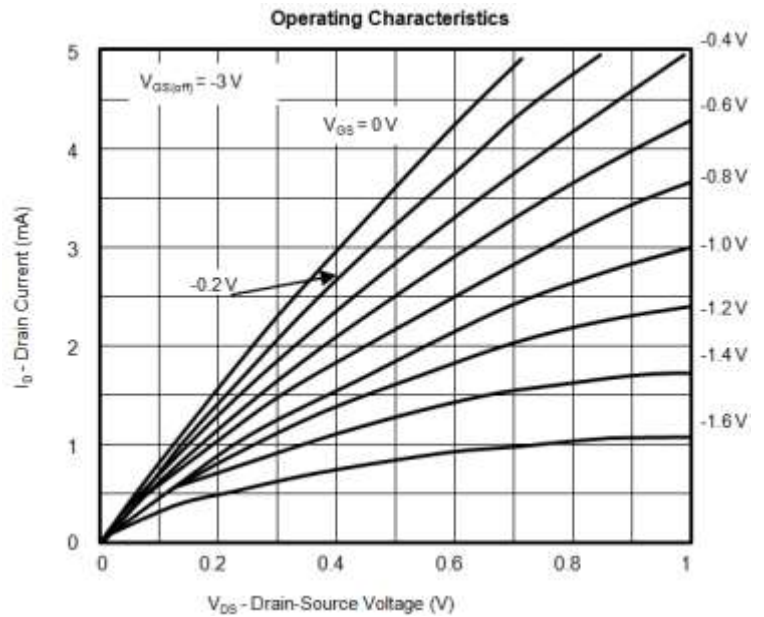
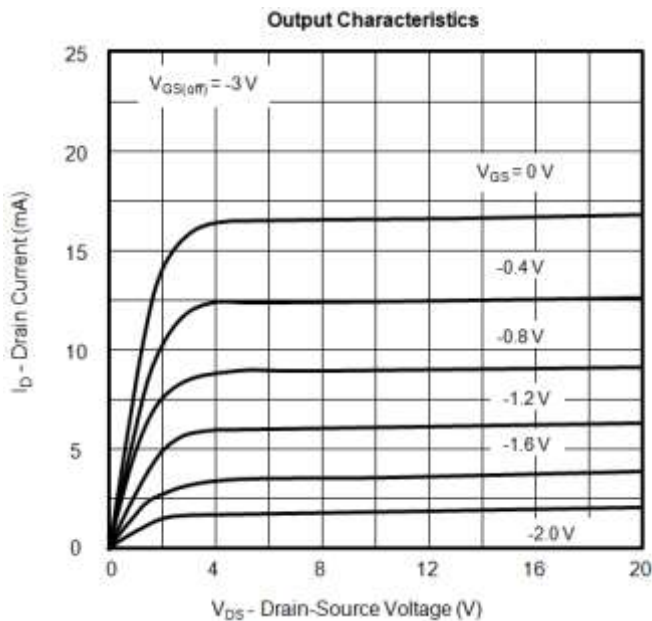
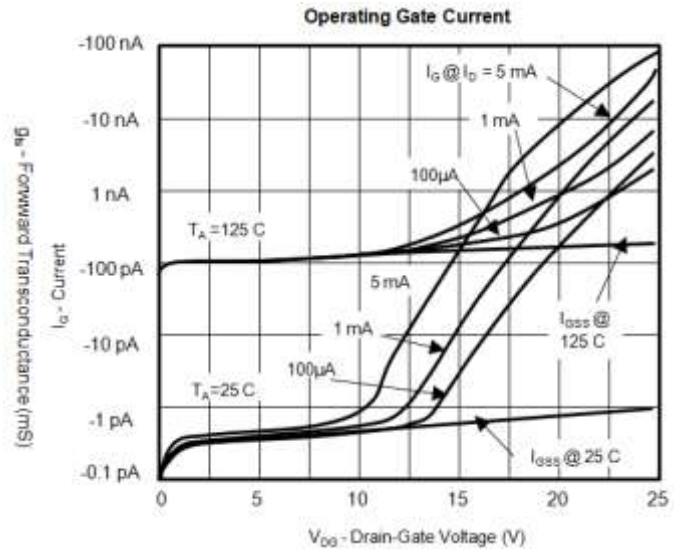
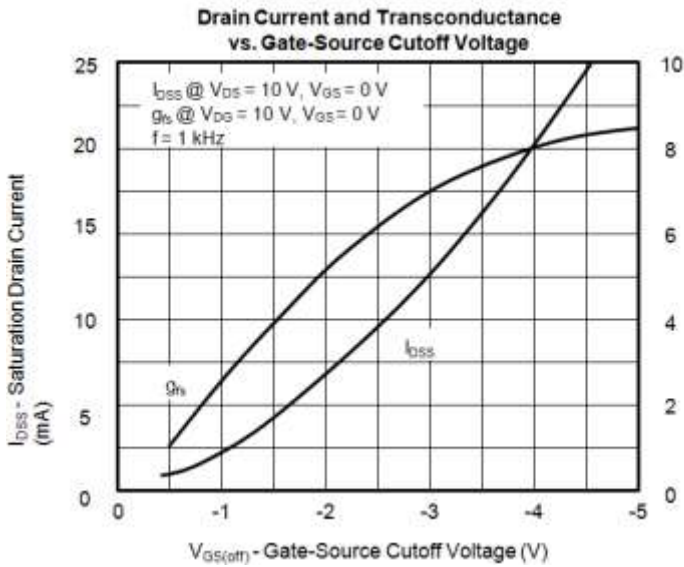

Typical Characteristics Continued

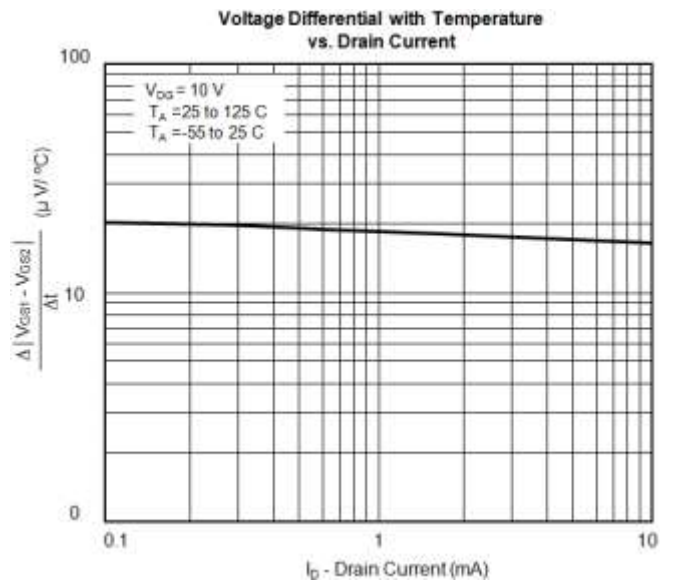
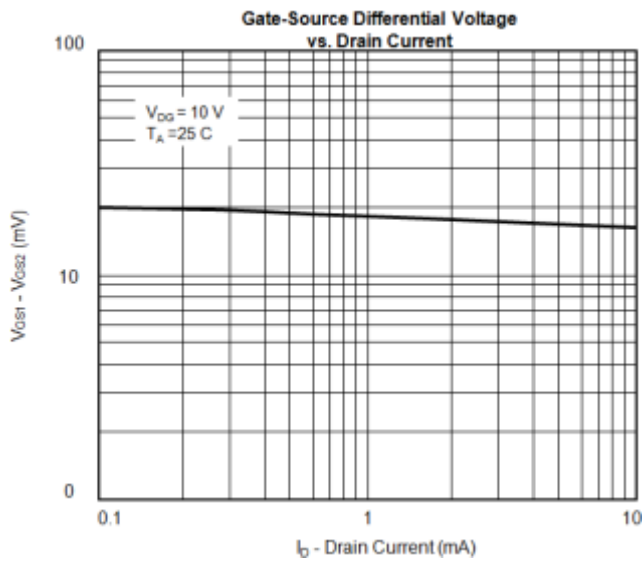
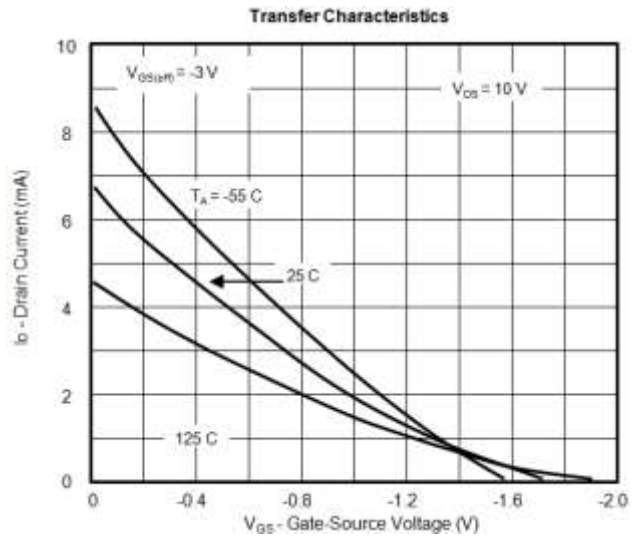
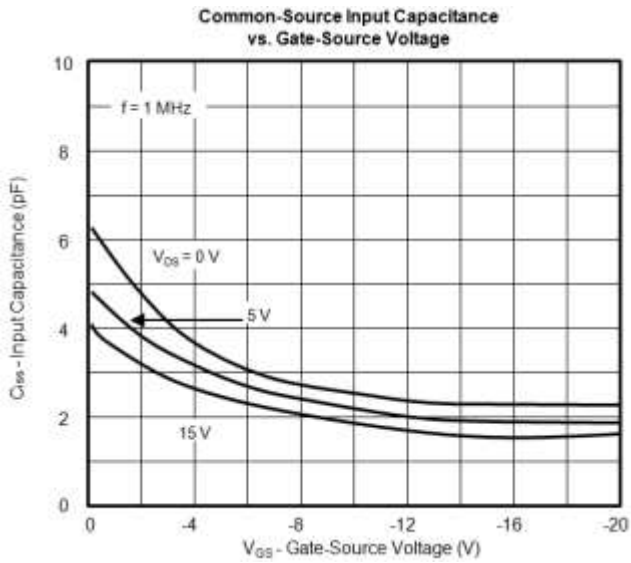

Typical Characteristics Continued

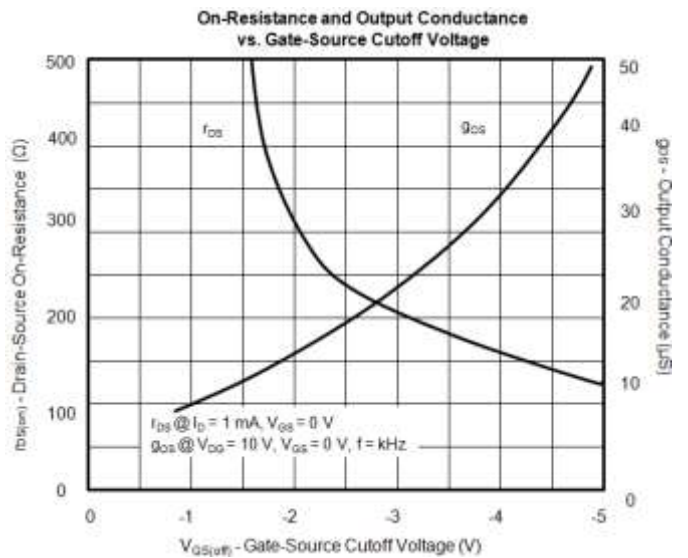
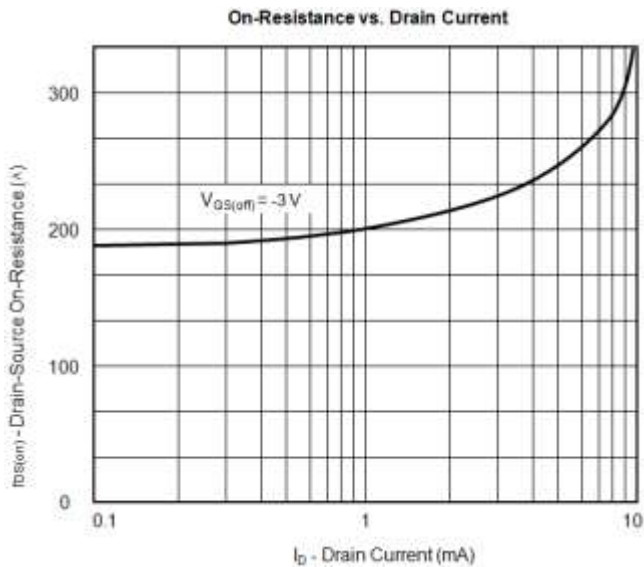
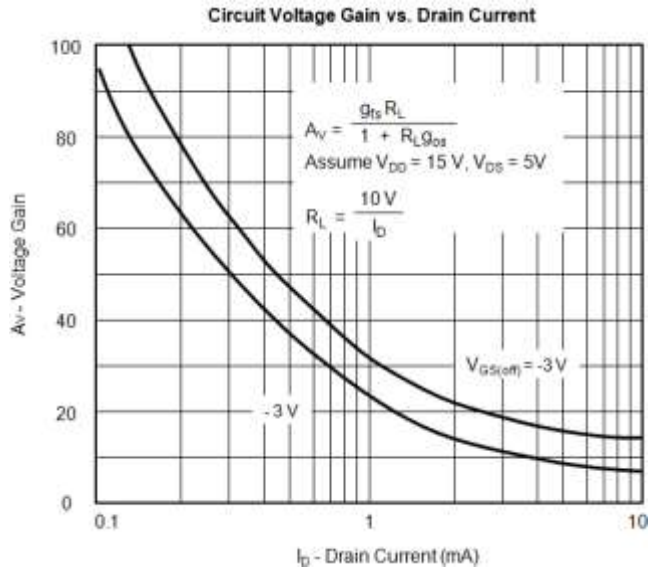
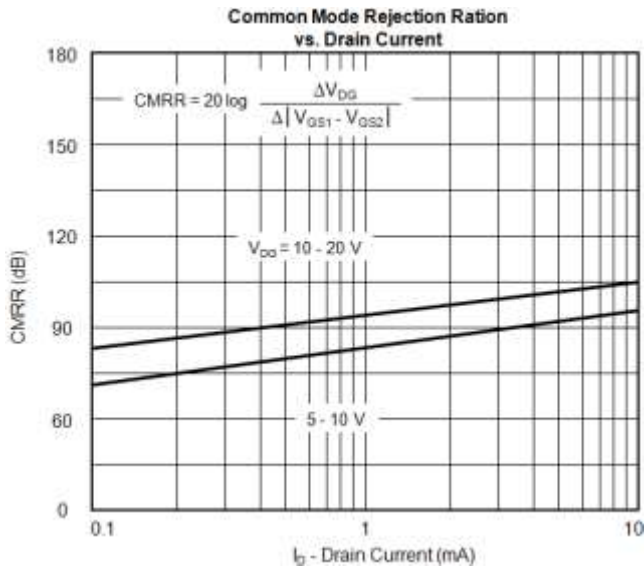

Typical Characteristics Continued

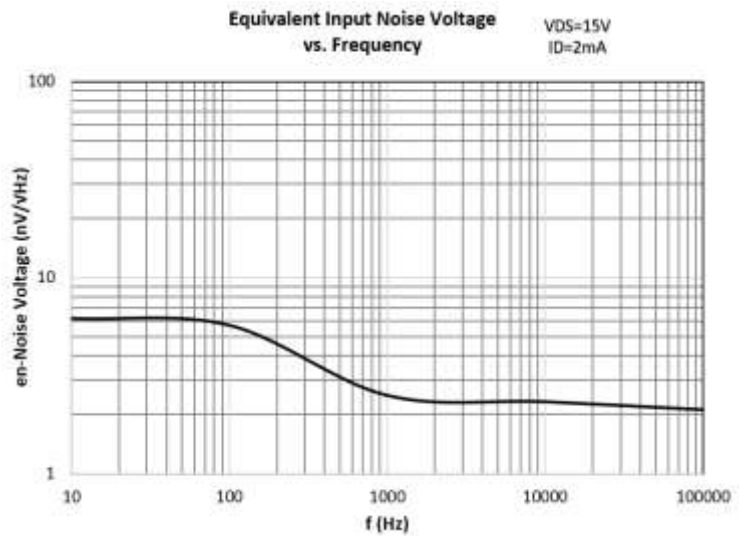
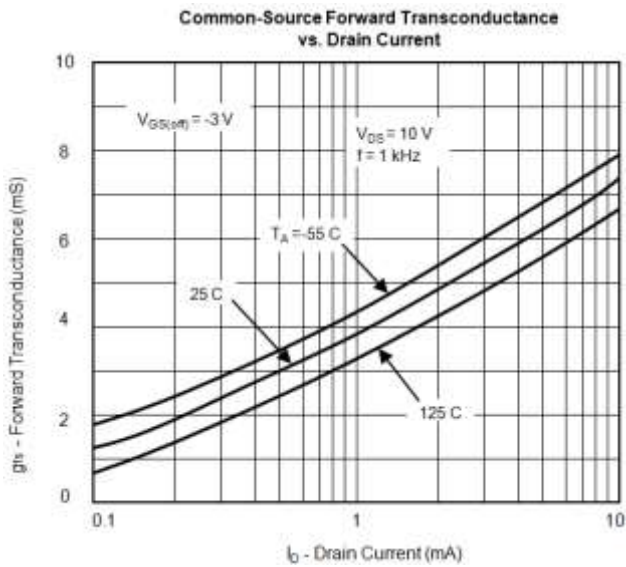
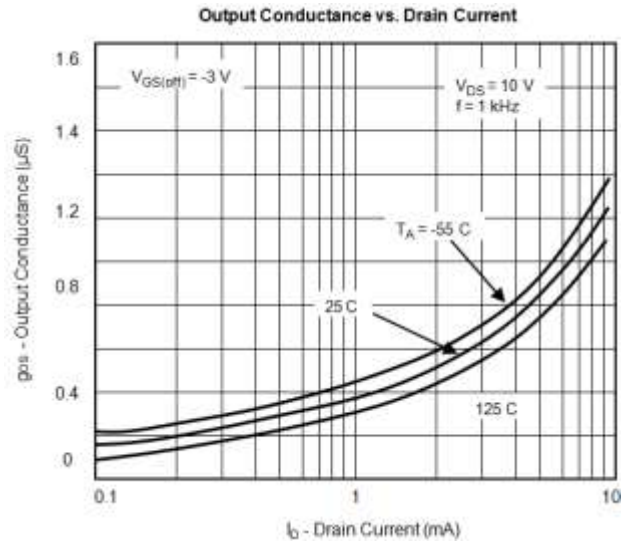
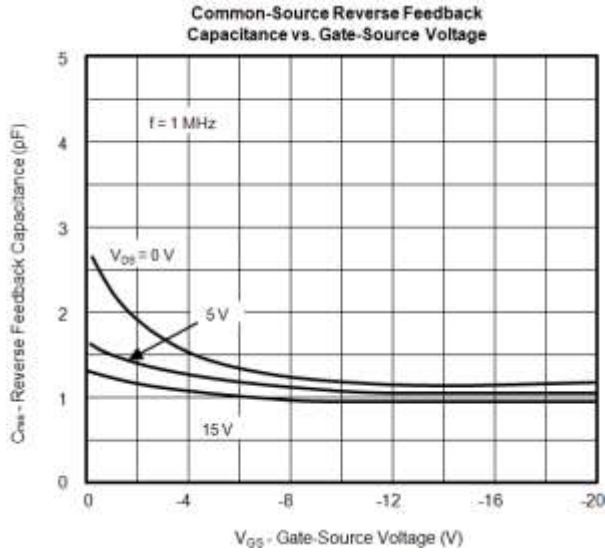

Package Dimensions:

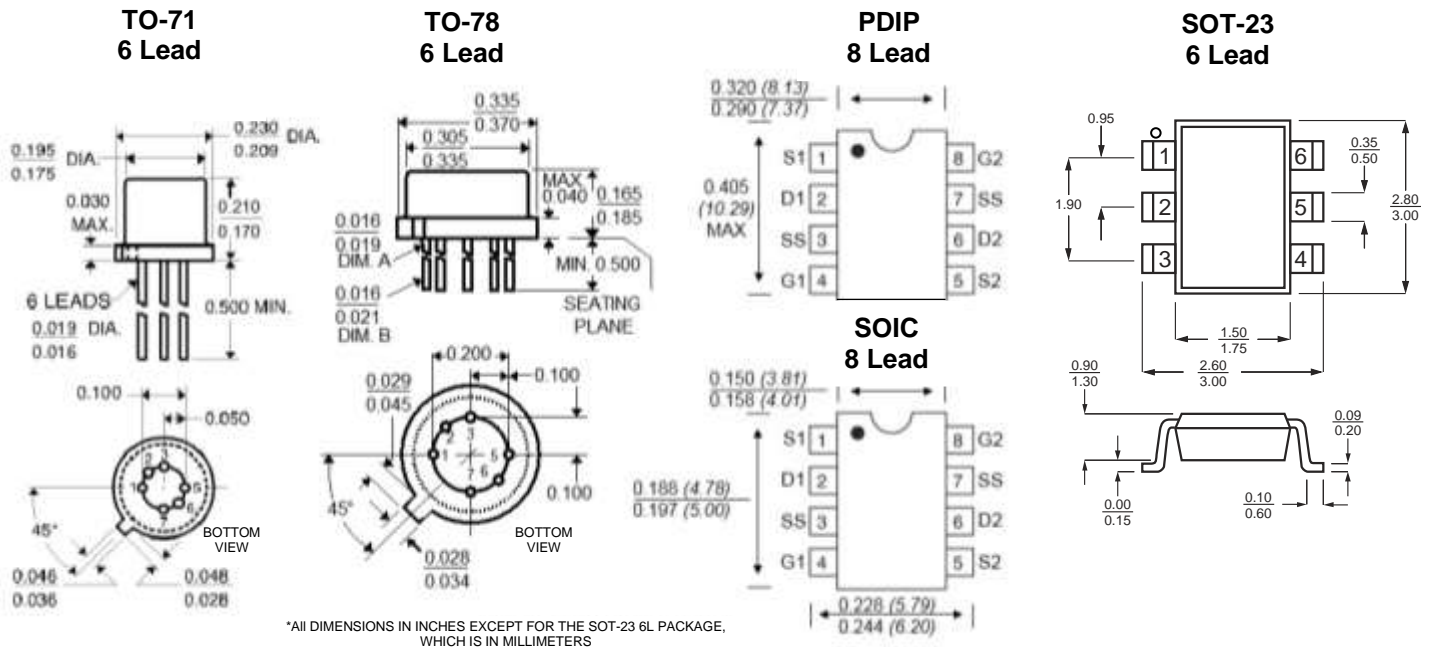

Ordering Information:

Standard Part Call-Out		
LS843 TO-71 6L RoHS	LS844 TO-71 6L RoHS	LS845 TO-71 6L RoHS
LS843 TO-78 6L RoHS	LS844 TO-78 6L RoHS	LS845 TO-78 6L RoHS
LS843 SOT-23 6L RoHS	LS844 SOT-23 6L RoHS	LS845 SOT-23 6L RoHS
LS843 SOIC 8L RoHS	LS844 SOIC 8L RoHS	LS845 SOIC 8L RoHS
LS843 PDIP 8L RoHS	LS844 PDIP 8L RoHS	LS845 PDIP 8L RoHS
Custom Part Call-Out (Custom Parts Include SEL + 4 Digit Numeric Code)		
LS843 TO-71 6L RoHS SELXXXX	LS844 TO-71 6L RoHS SELXXXX	LS845 TO-71 6L RoHS SELXXXX
LS843 TO-78 6L RoHS SELXXXX	LS844 TO-78 6L RoHS SELXXXX	LS845 TO-78 6L RoHS SELXXXX
LS843 SOT-23 6L RoHS SELXXXX	LS844 SOT-23 6L RoHS SELXXXX	LS845 SOT-23 6L RoHS SELXXXX
LS843 SOIC 8L RoHS SELXXXX	LS844 SOIC 8L RoHS SELXXXX	LS845 SOIC 8L RoHS SELXXXX
LS843 PDIP 8L RoHS SELXXXX	LS844 PDIP 8L RoHS SELXXXX	LS845 PDIP 8L RoHS SELXXXX