

BPCA Series



Features

- RoHS, Halogen Free and REACH Compliance
- Shielded power inductor

Applications

- Thin-screen TVs
- LCDs
- AV equipment
- STBs
- LED lights

Product Identification

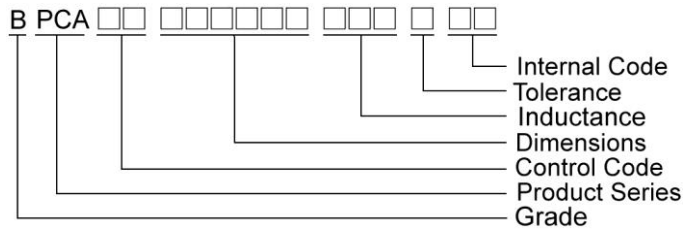

Shape and Dimensions

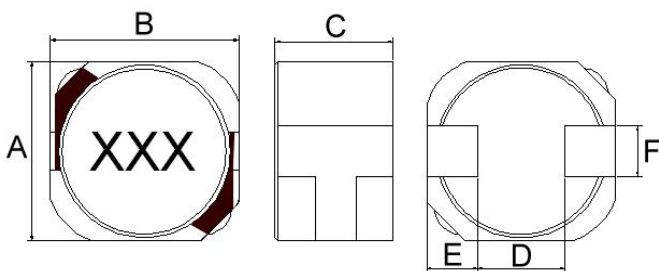

Recommended Pattern

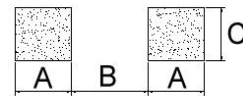

Dimensions in mm

TYPE	Shape and Dimensions						Recommended Pattern		
	A	B	C	D	E	F	A	B	C
BPCA00060645	6.0±0.2	6.3±0.2	4.6±0.3	2.9	1.7±0.1	2.0±0.1	2.1	2.8	2.2
BPCA00070745	7.0±0.2	7.4±0.2	4.5±0.3	3.4	2.0±0.1	2.0±0.1	2.4	3.3	2.2

SMD Shielded Power Inductors - BPCA Series

Shape and Dimensions

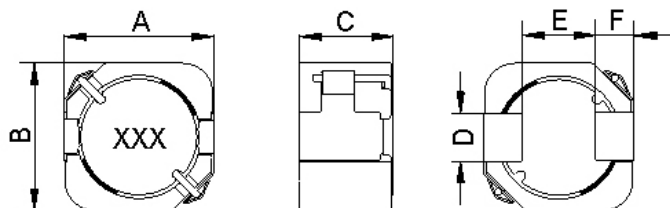

Recommended Pattern

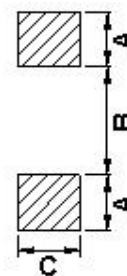

Dimensions in mm

TYPE	Shape and Dimensions						Recommended Pattern		
	A	B	C	D	E	F	A	B	C
BPCA00101065	10.3±0.3	10.0±0.3	6.5Max	3.5	4.5	2.65	3.3	4.3	3.7
BPCA00121280	12.5±0.4	12.3±0.4	8.0Max	4.0	6.3	3.15	4.5	6.0	4.3

Please be sure to request approval specifications that provide further details of the products. Kindly note that the content of these specifications are subject to change or may be discontinued without prior notice. This product may not be designed/used in medical or high risk applications without Chilisin approval. Please contact our sales department before ordering.

SMD Shielded Power Inductors - BPCA Series

Standard Specifications

Part Number	Inductance (uH)	Tolerance (±%)	Test Frequency (kHz)	RDC (Ω) Max	Isat (A) Typ(Max)	Irms (A)	Marking
BPCA000606451R0□00	1.0	30	100	0.0143	6.7(6.0)	4.8	1R0
BPCA000606451R5□00	1.5	30	100	0.0169	5.5(5.2)	4.5	1R5
BPCA000606452R2□00	2.2	30	100	0.0195	4.2(3.6)	4.1	2R2
BPCA000606453R3□00	3.3	30	100	0.0247	3.5(3.2)	3.7	3R3
BPCA000606454R7□00	4.7	30	100	0.0299	3.1(2.5)	3.3	4R7
BPCA000606456R8□00	6.8	30	100	0.0351	2.8(2.0)	3.1	6R8
BPCA00060645100□00	10	20	100	0.042	2.1(1.7)	2.6	100
BPCA00060645150□00	15	20	100	0.072	1.7(1.4)	2.0	150
BPCA00060645220□00	22	20	100	0.09	1.4(1.1)	1.8	220
BPCA00060645330□00	33	20	100	0.12	1.1(0.9)	1.6	330
BPCA00060645470□00	47	20	100	0.156	0.97(0.78)	1.4	470
BPCA00060645680□00	68	20	100	0.24	0.81(0.65)	1.1	680
BPCA00060645101□00	100	20	100	0.384	0.61(0.55)	0.86	101
BPCA00060645151□00	150	20	100	0.576	0.53(0.46)	0.72	151
BPCA00060645221□00	220	20	100	0.864	0.47(0.36)	0.57	221
BPCA00060645331□00	330	20	100	1.104	0.36(0.28)	0.49	331
BPCA00060645471□00	470	20	100	1.56	0.28(0.25)	0.41	471

Note: When ordering, please specify tolerance code. Tolerance: M=±20% , T=±30%

- Operating temperature range – 40°C ~ 105°C (Including self - temperature rise)
- Isat for Inductance drop 30% from its value without current
- The actual use current is suggested not to be out of Isat*80%
- I rms for a 40°C temprature rise from 25°C ambient.
- Measure Equipment :
 L : HP4284+42841A, 100kHz/ 1V
 RDC : Chroma 16502
 Isat : HP4284+42841A

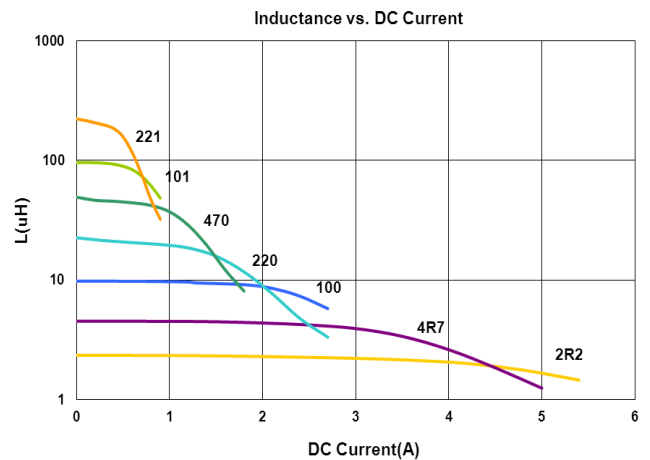
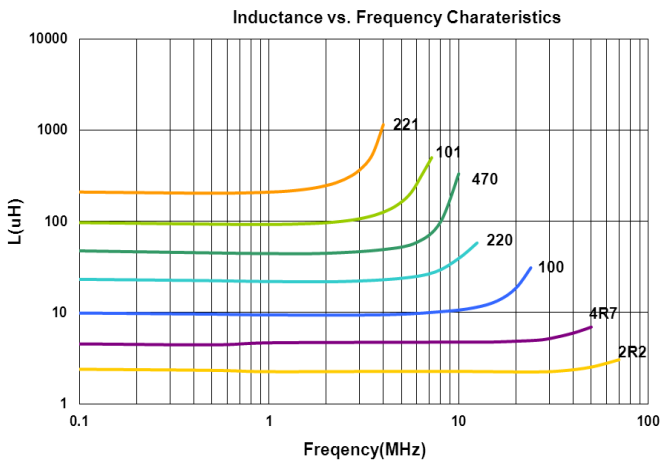

Please be sure to request approval specifications that provide further details of the products. Kindly note that the content of these specifications are subject to change or may be discontinued without prior notice. This product may not be designed/used in medical or high risk applications without Chilisin approval. Please contact our sales department before ordering.

SMD Shielded Power Inductors - BPCA Series

Standard Specifications

Part Number	Inductance (uH)	Tolerance (±%)	Test Frequency (kHz)	RDC (Ω) Max	Isat (A) Typ(Max)	Irms (A)	Marking
BPCA000707451R0□00	1.0	30	100	0.0117	9.3(7.6)	6.5	1R0
BPCA000707451R5□00	1.5	30	100	0.013	7.8(6.2)	5.4	1R5
BPCA000707452R2□00	2.2	30	100	0.0169	7.3(6.0)	5.1	2R2
BPCA000707453R3□00	3.3	30	100	0.0208	5.8(4.6)	4.8	3R3
BPCA000707454R7□00	4.7	30	100	0.0234	4.8(4.0)	4.1	4R7
BPCA000707456R8□00	6.8	30	100	0.0264	3.6(3.0)	3.9	6R8
BPCA00070745100□00	10	20	100	0.0396	3.2(2.6)	3.1	100
BPCA00070745150□00	15	20	100	0.066	2.4(2.0)	2.6	150
BPCA00070745220□00	22	20	100	0.0828	2.1(1.6)	2.2	220
BPCA00070745330□00	33	20	100	0.116	1.6(1.3)	1.8	330
BPCA00070745470□00	47	20	100	0.156	1.3(1.1)	1.7	470
BPCA00070745680□00	68	20	100	0.204	1.08(0.95)	1.5	680
BPCA00070745101□00	100	20	100	0.312	0.9(0.8)	1.05	101
BPCA00070745151□00	150	20	100	0.516	0.8(0.65)	0.95	151
BPCA00070745221□00	220	20	100	0.66	0.7(0.54)	0.75	221
BPCA00070745331□00	330	20	100	0.96	0.55(0.45)	0.58	331
BPCA00070745471□00	470	20	100	1.44	0.45(0.37)	0.46	471

Note: When ordering, please specify tolerance code. Tolerance: M=±20% , T=±30%

- Operating temperature range – 40°C ~ 105°C (Including self - temperature rise)
- Isat for Inductance drop 30% from its value without current
- The actual use current is suggested not to be out of Isat*80%
- I rms for a 40°C temprature rise from 25°C ambient.
- Measure Equipment :
 L : HP4284+42841A, 100kHz/ 1V
 RDC : Chroma 16502
 Isat : HP4284+42841A

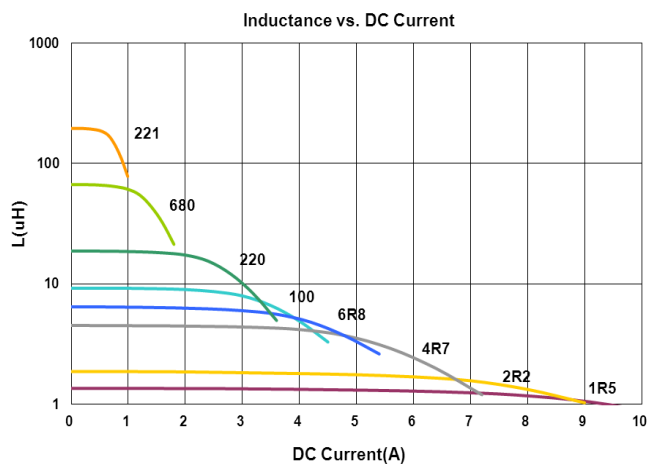
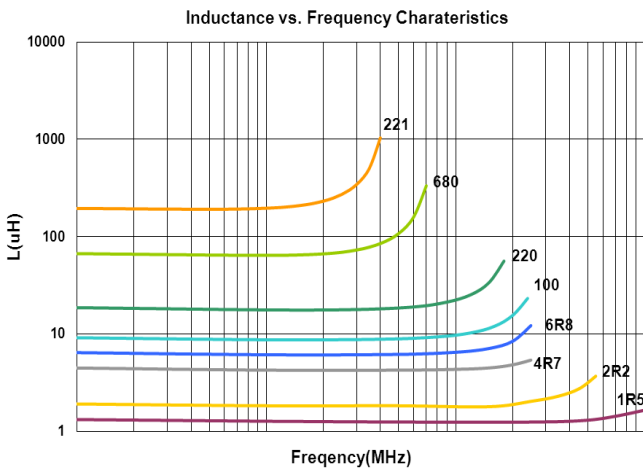

Please be sure to request approval specifications that provide further details of the products. Kindly note that the content of these specifications are subject to change or may be discontinued without prior notice. This product may not be designed/used in medical or high risk applications without Chilisin approval. Please contact our sales department before ordering.

SMD Shielded Power Inductors - BPCA Series

Standard Specifications

Part Number	Inductance (uH)	Tolerance (±%)	Test Frequency	RDC (mΩ)	Isat (A)Typ	Irms (A)Typ	Marking
BPCA001010652R2□A0	2.2	30	100kHz,0.25V	7.1±30%	11.00	8.50	2R2
BPCA001010653R3□A0	3.3	30	100kHz,0.25V	8.5±30%	8.40	8.10	3R3
BPCA001010654R7□A0	4.7	30	100kHz,0.25V	11±30%	8.00	7.00	4R7
BPCA001010656R8□A0	6.8	30	100kHz,0.25V	13±30%	6.50	6.60	6R8
BPCA00101065100□A0	10	20,30	100kHz,0.25V	17±20%	5.00	5.80	100
BPCA00101065150□A0	15	20,30	100kHz,0.25V	30±20%	4.40	4.10	150
BPCA00101065220□A0	22	20,30	100kHz,0.25V	43±20%	3.60	3.30	220
BPCA00101065330□A0	33	20,30	100kHz,0.25V	61±20%	3.10	2.90	330
BPCA00101065470□A0	47	20,30	100kHz,0.25V	74±20%	2.35	2.60	470
BPCA00101065680□A0	68	20,30	100kHz,0.25V	91±20%	2.05	2.40	680
BPCA00101065101□A0	100	20,30	100kHz,0.25V	150±20%	1.65	1.90	101
BPCA00101065151□A0	150	20,30	100kHz,0.25V	240±20%	1.35	1.50	151
BPCA00101065221□A0	220	20,30	100kHz,0.25V	350±20%	1.10	1.20	221
BPCA00101065331□A0	330	20,30	100kHz,0.25V	445±20%	0.90	1.10	331
BPCA00101065471□A0	470	20,30	100kHz,0.25V	600±20%	0.75	0.90	471

Note: When ordering, please specify tolerance code. Tolerance: M=±20% , T=±30%

- Operating temperature range – 40°C ~ 125°C (Including self - temperature rise)
- Isat for Inductance drop 30% from its value without current
- I rms for a 40°C temperature rise from 25°C ambient with current
- Measure Equipment :
L: HP4284+42841A,
RDC: Chroma 16502
Isat:WK3255BQ+ WK3265B
I rms: WK3255BQ+ WK3265B

SMD Shielded Power Inductors - BPCA Series

Standard Specifications

Part Number	Inductance (uH)	Tolerance (±%)	Test Frequency	RDC (mΩ)	Isat (A)Typ	Irms (A)Typ	Marking
BPCA001212801R5□A0	1.5	30	100kHz,0.25V	5.5±30%	23.50	10.50	1R5
BPCA001212802R2□A0	2.2	30	100kHz,0.25V	6.3±30%	20.00	9.70	2R2
BPCA001212803R3□A0	3.3	30	100kHz,0.25V	7.7±30%	15.00	9.50	3R3
BPCA001212804R7□A0	4.7	30	100kHz,0.25V	8.7±30%	13.00	9.00	4R7
BPCA001212806R8□A0	6.8	30	100kHz,0.25V	10±20%	9.70	8.50	6R8
BPCA00121280100□A0	10	20,30	100kHz,0.25V	12±20%	9.20	7.70	100
BPCA00121280150□A0	15	20,30	100kHz,0.25V	24±20%	7.40	5.10	150
BPCA00121280220□A0	22	20,30	100kHz,0.25V	27±20%	5.80	4.50	220
BPCA00121280330□A0	33	20,30	100kHz,0.25V	52±20%	4.50	3.60	330
BPCA00121280470□A0	47	20,30	100kHz,0.25V	66±20%	4.20	3.20	470
BPCA00121280680□A0	68	20,30	100kHz,0.25V	90±20%	3.60	2.70	680
BPCA00121280101□A0	100	20,30	100kHz,0.25V	110±20%	2.90	2.60	101
BPCA00121280151□A0	150	20,30	100kHz,0.25V	170±20%	2.40	2.10	151
BPCA00121280221□A0	220	20,30	100kHz,0.25V	280±20%	1.95	1.60	221
BPCA00121280331□A0	330	20,30	100kHz,0.25V	410±20%	1.60	1.25	331
BPCA00121280471□A0	470	20,30	100kHz,0.25V	590±20%	1.30	1.10	471

Note: When ordering, please specify tolerance code. Tolerance: M=±20% , T=±30%

- Operating temperature range – 40°C ~ 125°C (Including self - temperature rise)
- Isat for Inductance drop 30% from its value without current
- I rms for a 40°C temperature rise from 25°C ambient with current
- Measure Equipment :
L: HP4284+42841A,
RDC: Chroma 16502
Isat:WK3255BQ+ WK3265B
I rms: WK3255BQ+ WK3265B

SMD Shielded Power Inductors - BPCA Series

Packaging Specifications

Tape Dimensions

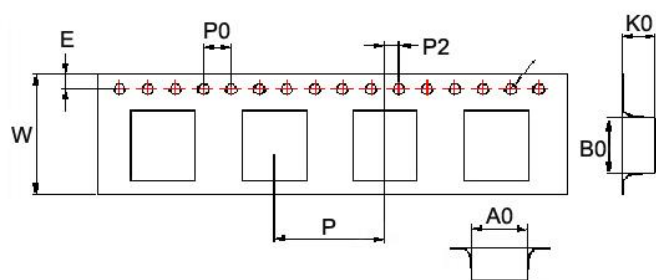

Tape Material

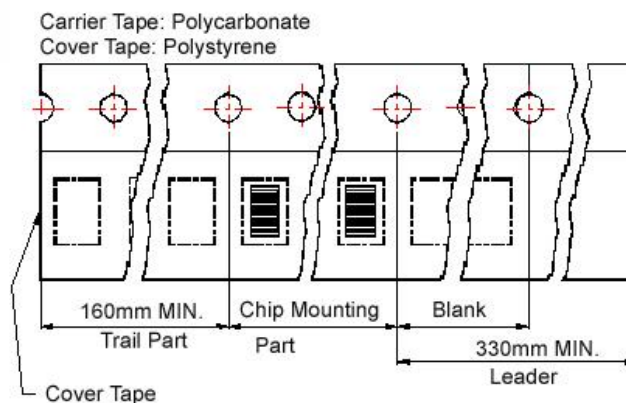

Reel Dimensions

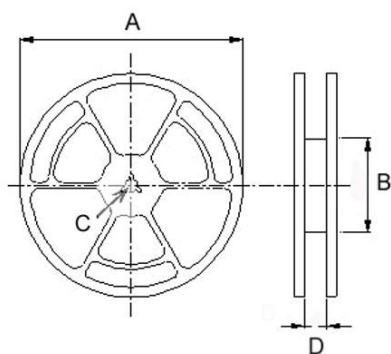

Dimensions in mm

TYPE	Tape Dimensions									Reel Dimensions				Quantity PCS / REEL
	A0	B0	K0	D	E	W	P	P0	P2	A	B	C	D	
BPCA00060645	6.9	6.3	5	1.55	1.75	16	12	4	2	330	100	13	16	1000
BPCA00070745	7.7	7.35	5	1.55	1.75	16	12	4	2	330	100	13	16	1000
BPCA00101065	10.4	10.65	6.7	1.50	1.75	24	16	4	2	330	100	13	24	500
BPCA00121280	12.8	13	8.7	1.50	1.75	24	16	4	2	330	100	13	24	400