

HS41xx

High-Performance Relative Humidity and Temperature Sensor with Analog Output

The HS41xx series is a highly accurate, fully calibrated automotive grade relative humidity and temperature sensor with an analog output. While the HS410x series comes in a standard package with an open air inlet, the HS411x series features a hydrophobic membrane, making it dust resistant and waterproof with IP67 rating. Both sensor versions, waterproof and non-waterproof, are available in two different accuracy classes, HS41x1 and HS41x3. The MEMS sensor features a proprietary sensor-level protection, ensuring high reliability and long-term stability.

Integrated calibration using a NIST traceable and verified production setup that is calibrated to ISO/IEC 17025 standards and temperature-compensation logic provides fully corrected RH and temperature values via an analog output. User calibration of the output data is not required.

The high accuracy, fast measurement response time, and long-term stability, combined with the small package size, makes the HS41xx ideal for a wide number of applications ranging from portable devices to products designed for harsh environments.

The HS41xx are digital sensors at their core. Measurements are then converted to ratio-metric analog output. This makes the HS41xx suitable for high-noise environment applications.

Physical Characteristics

- Supply voltage of 1.71V to 3.6V
- Operating temperature of -40°C to +105°C
- 2.5 × 2.5 × 0.9 mm DFN-style 8-LGA package

Product Image

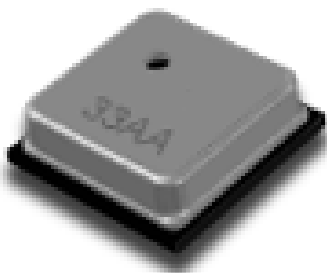

Features

- Humidity range: 0% to 100%RH
- Industrial grade, JEDEC qualified, -40°C to +105°C
- Automotive grade, AEC-Q100 qualified, Grade 2, -40°C to +105°C
- ESD Human Body Model, JESD22-A114, Class 2
- ESD Charged Device Model, JESD22-C101, Class C2
- NIST traceability for relative humidity and temperature
- Hydrophobic membrane, IP67 rating (HS411x)
- 10% to 90% ratio-metric analog output voltage
- RH accuracy: ±1.5%RH, typical (HS41x1)
- Fast RH response time: 4 seconds time constant, typical
- Temperature sensor accuracy: ±0.2°C, typical (HS41x1, -10 to +80°C)
- Very low current consumption: 92µA average (3.3V supply)
- Excellent stability against aging and volatile compounds
- Highly robust protection from harsh environmental conditions and mechanical shock

Applications

- Climate control systems
- Instrumentation
- Home appliances
- Weather stations
- Building automation
- HVAC systems
- Medical equipment
- Data logging systems

Contents

1. Pin Information	4
1.1 Pin Assignments	4
1.2 Pin Descriptions	4
2. Specifications	5
2.1 Absolute Maximum Ratings	5
2.2 Recommended Operating Conditions	5
3. Humidity and Temperature Sensor Performance	6
3.1 Humidity Sensor Specifications	6
3.2 Temperature Sensor Specifications	6
3.3 Humidity Sensor Accuracy Graphs	7
3.4 Temperature Sensor Accuracy Graphs	7
4. Sensor Startup	8
5. Application Circuit	8
6. Converting Output Signal	8
7. Soldering Information	10
8. PCB Layout Guide	11
9. Storage and Handling	11
10. Quality and Reliability	11
11. Package Outline Drawings	12
12. Marking Diagram	12
13. Ordering Information	12
14. Revision History	12

List of Figures

Figure 1. Pin Assignments – Top View.....	4
Figure 2. HS41x1 RH Accuracy Tolerance at 25°C	7
Figure 3. HS41x1 RH Accuracy over Temperature.....	7
Figure 4. HS41x3 RH Accuracy Tolerance at 25°C	7
Figure 5. HS41x3 RH Accuracy over Temperature.....	7
Figure 6. HS41x1 Temperature Sensor Accuracy Tolerance.....	7
Figure 7. HS41x3 Temperature Sensor Accuracy Tolerance.....	7
Figure 8. HS41xx Application Circuit	8
Figure 9. Relative Humidity vs. VRH Output Analog Voltage.....	9
Figure 10. Temperature vs. VT Output Analog Voltage	9
Figure 11. Recommended Soldering Profile.....	10
Figure 12. Milled PCB Openings for Thermal Isolation	11

List of Tables

Table 1. Humidity Sensor Specifications, $T_A = +25^{\circ}\text{C}$, $V_{DD} = 1.71\text{V}$ to 3.6V	6
Table 2. Temperature Sensor Specifications, $T_A = +25^{\circ}\text{C}$, $V_{DD} = 1.71\text{V}$ to 3.6V	6

1. Pin Information

1.1 Pin Assignments

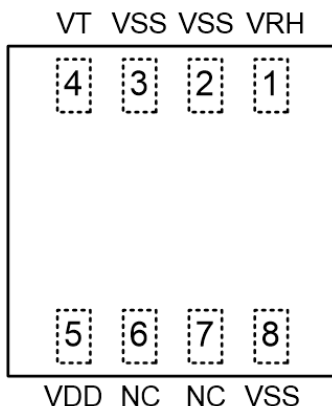

Figure 1. Pin Assignments – Top View

1.2 Pin Descriptions

Pin Number	Pin Name	Type	Description
1	VRH ^[1]	Out	Analog RH output voltage.
2	VSS	In	Ground.
3	VSS	In	Ground.
4	VT ^[1]	Out	Analog temperature output voltage.
5	VDD	In	Supply voltage.
6	NC ^[2]	-	Do not connect.
7	NC ^[2]	-	Do not connect.
8	VSS	In	Ground.

1. VRH and VT requires a capacitor (for more information, see Application Circuit).
2. “NC” stands for not connected / no connection required / not bonded.

2. Specifications

2.1 Absolute Maximum Ratings

CAUTION: The absolute maximum ratings are stress ratings only. Stresses greater than those listed below can cause permanent damage to the device. Functional operation of the HS41xx at absolute maximum ratings is not implied. Exposure to absolute maximum rating conditions might affect device reliability.

Parameter	Conditions	Minimum	Maximum	Unit
Supply Voltage		-0.3	3.6	V
Storage Temperature Range	Recommended 0 to 60°C	-40	125	°C

2.2 Recommended Operating Conditions

Important: The HS41xx series sensors are optimized to perform best in the more common temperature and humidity ranges of 10°C to 50°C and 20% RH to 80% RH, respectively. If operated outside of these conditions for extended periods, especially at high humidity levels, the sensors may exhibit an offset. In most cases, this offset is temporary and will gradually disappear once the sensor is returned to normal temperature and humidity conditions. The amount of the shift and the duration of the offset vary depending on the duration of exposure and the severity of the relative humidity and temperature conditions.^[1] The time needed for the offset to disappear can also be decreased by using the procedures described in sections 9 and 10.

Parameter	Condition	Minimum	Typical	Maximum	Unit
Operating Supply Voltage		1.71	3.3	3.6	V
Average Current	V _{DD} = 1.8V	-	82	95	μA
	V _{DD} = 3.3V	-	92	110	
Measurement Time	Humidity and temperature measurement	-	1.7	2.3	ms
Operating Temperature Range		-40	-	105	°C

1. At T_A = +25°C, V_{DD} = +1.71V to +3.6V unless otherwise noted.

3. Humidity and Temperature Sensor Performance

3.1 Humidity Sensor Specifications

Table 1. Humidity Sensor Specifications, T_A = +25°C, V_{DD} = 1.71V to 3.6V

Parameter	Condition		Minimum	Typical	Maximum	Unit
Range			0	-	100	%RH
Accuracy ^{[1][2]}	HS41x1	10% to 90%RH	-	±1.5	±1.8	%RH
	HS41x3	20% to 80%RH	-	±2.5	±3.5	
Resolution	14-bit		-	0.04	0.05	%RH
Hysteresis			-	-	±1.0	%RH
Non-Linearity from Response Curve	HS41x1	10% to 90%RH	-	±0.15	±0.25	%RH
	HS41x3	20% to 80%RH				
Long-Term Stability			-	±0.1	±0.25	%RH/Yr
Response Time Constant ^[3] (τ _H)	20% to 80% RH Still Air		3.0	4.0	6.0	sec

1. Monotonic increases from 10 to 90% RH after sensor has been stabilized at 50% RH.
2. For more information, see section 3.3.
3. Initial value to 63% of total variation. The response time depends on system airflow.

3.2 Temperature Sensor Specifications

Table 2. Temperature Sensor Specifications, T_A = +25°C, V_{DD} = 1.71V to 3.6V

Parameter	Condition		Minimum	Typical	Maximum	Unit
Range			-40	-	105	°C
Accuracy ^[1]	HS41x1	-10°C to 80°C	-	±0.2	±0.3	°C
	HS41x3	0°C to 70°C	-	±0.25	±0.35	
Resolution			-	0.01	0.02	°C
Response Time Constant ^[2] (τ _T)			-	>2.0	-	Sec.
Long-Term Stability			-	-	0.03	°C/Yr
Supply Voltage Dependency ^[3]			-	0.03	0.1	°C/V

1. For more information, see section 3.4.
2. Initial value to 63% of total variation. The response time depends on system thermal mass and air flow.
3. Temperature accuracy can be optimized for specified supply voltages upon request.

3.3 Humidity Sensor Accuracy Graphs

The typical and maximum relative humidity sensor accuracy tolerances are shown in the following figures.

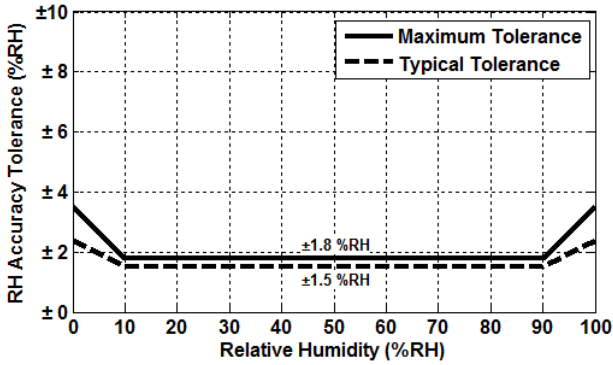

Figure 2. HS41x1 RH Accuracy Tolerance at 25°C

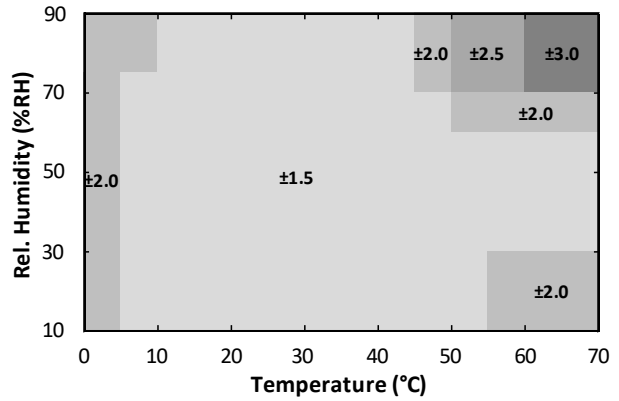

Figure 3. HS41x1 RH Accuracy over Temperature

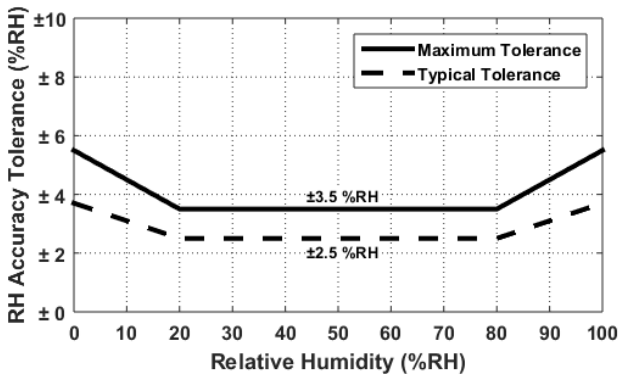

Figure 4. HS41x3 RH Accuracy Tolerance at 25°C

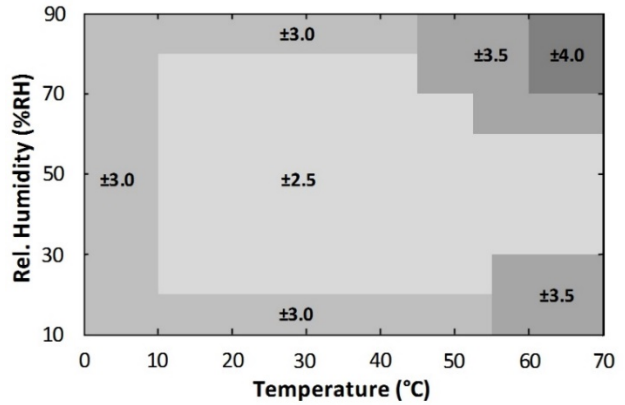

Figure 5. HS41x3 RH Accuracy over Temperature

3.4 Temperature Sensor Accuracy Graphs

The typical and maximum temperature sensor accuracy tolerances are shown in the following figures.

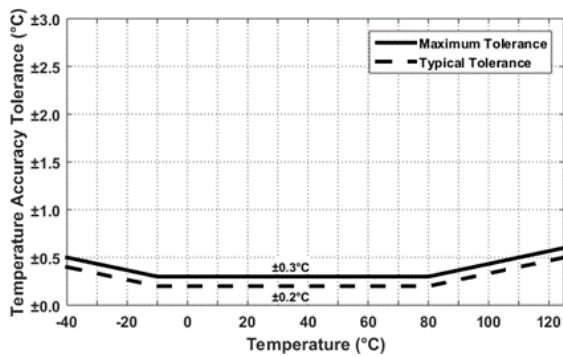

Figure 6. HS41x1 Temperature Sensor Accuracy Tolerance

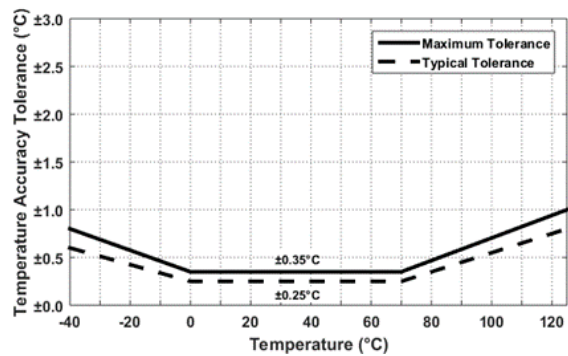

Figure 7. HS41x3 Temperature Sensor Accuracy Tolerance

4. Sensor Startup

The HS41xx sensor requires a typical 100ms to start up, after which temperature and relative humidity measurement data will be provided on the corresponding pins.

5. Application Circuit

The HS41xx sensor requires a 2.2μF ceramic capacitor connected to the ground on both the VRH and VT outputs. It is also recommended to buffer the output of the relative humidity and temperature signals before processing the analog voltage. The buffer should have a low input leakage current, < 1nA, and a low input offset voltage, < 1mV, to ensure high signal integrity.

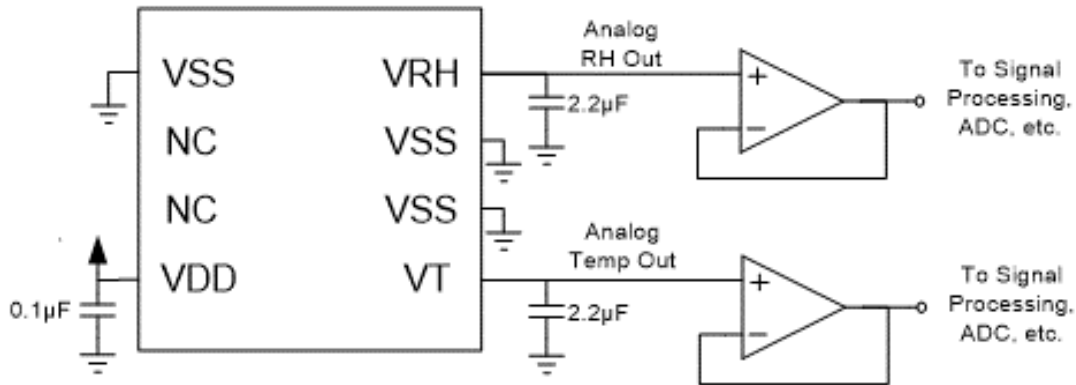

Figure 8. HS41xx Application Circuit

6. Converting Output Signal

The voltage levels of the filtered analog output signal are ratio-metric with V_{DD} . The default output range for the relative humidity and temperature is from 10% to 90%.

Each HS41xx sensor is individually calibrated so that a standard linear fitting equation can be used to obtain the measured temperature and RH value. Figure 9 and Figure 10 shows the RH and temperature graphically.

The relative humidity (in percent) and the temperature (in degrees Celsius) are calculated with Equation 1 and Equation 2, respectively.

$$\text{Humidity } [\%RH] = 125 * \frac{VRH}{VDD} - 12.5 \quad \text{Equation 1}$$

$$\text{Temperature } [^{\circ}C] = 181.25 * \frac{VT}{VDD} - 58.125 \quad \text{Equation 2}$$

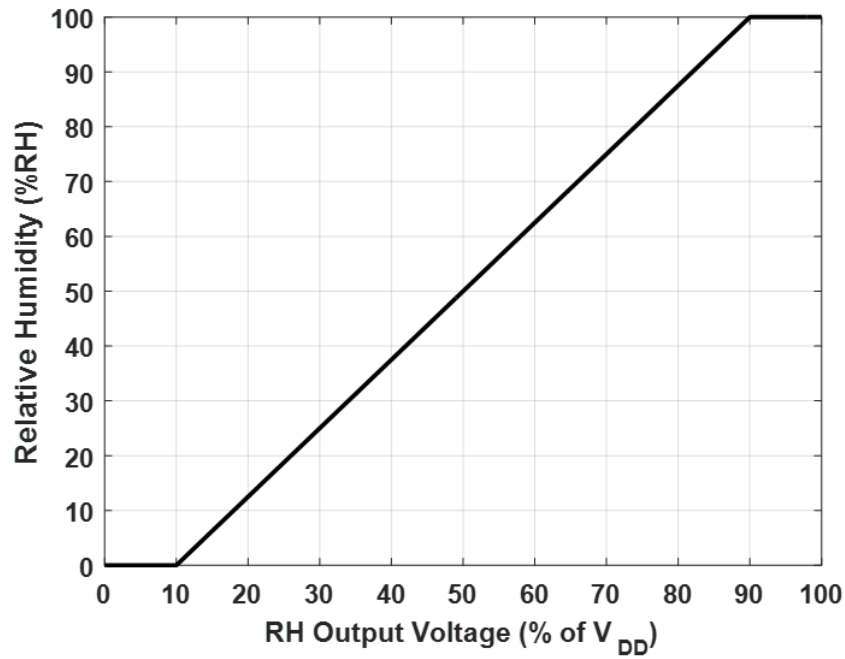

Figure 9. Relative Humidity vs. VRH Output Analog Voltage

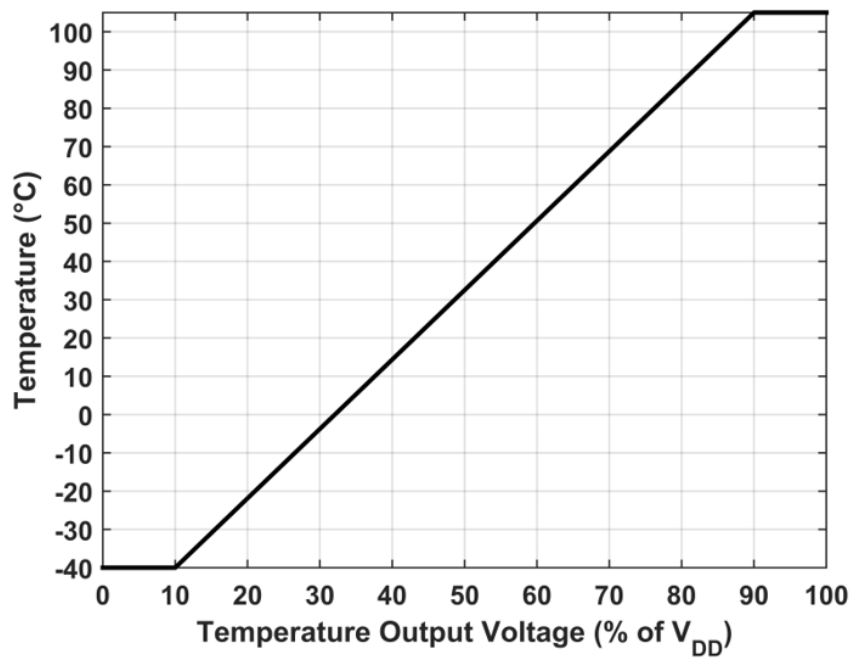

Figure 10. Temperature vs. VT Output Analog Voltage

7. Soldering Information

This section discusses soldering considerations for the HS41xx.

Standard reflow ovens can be used to solder the HS41xx series sensor to the PCB. The peak temperature (T_p) for use with the JEDEC J-STD-020D standard soldering profile is 260°C. For manual soldering, the contact time must be limited to 5 seconds at up to 350°C. In either case, if solder paste is used, it is recommended to use “no-clean” solder paste to avoid the need to wash the PCB.

When a relative humidity sensor is exposed to the high heat associated with the soldering process, the sensor element tends to dry out. To avoid an offset in the relative humidity readings, the sensor element must be rehydrated after the soldering process. Care must also be taken when selecting the temperatures and durations involved in the soldering process to avoid irreversibly damaging the sensor element.

The recommended soldering profile for a lead-free (RoHS-compliant) process is shown below.

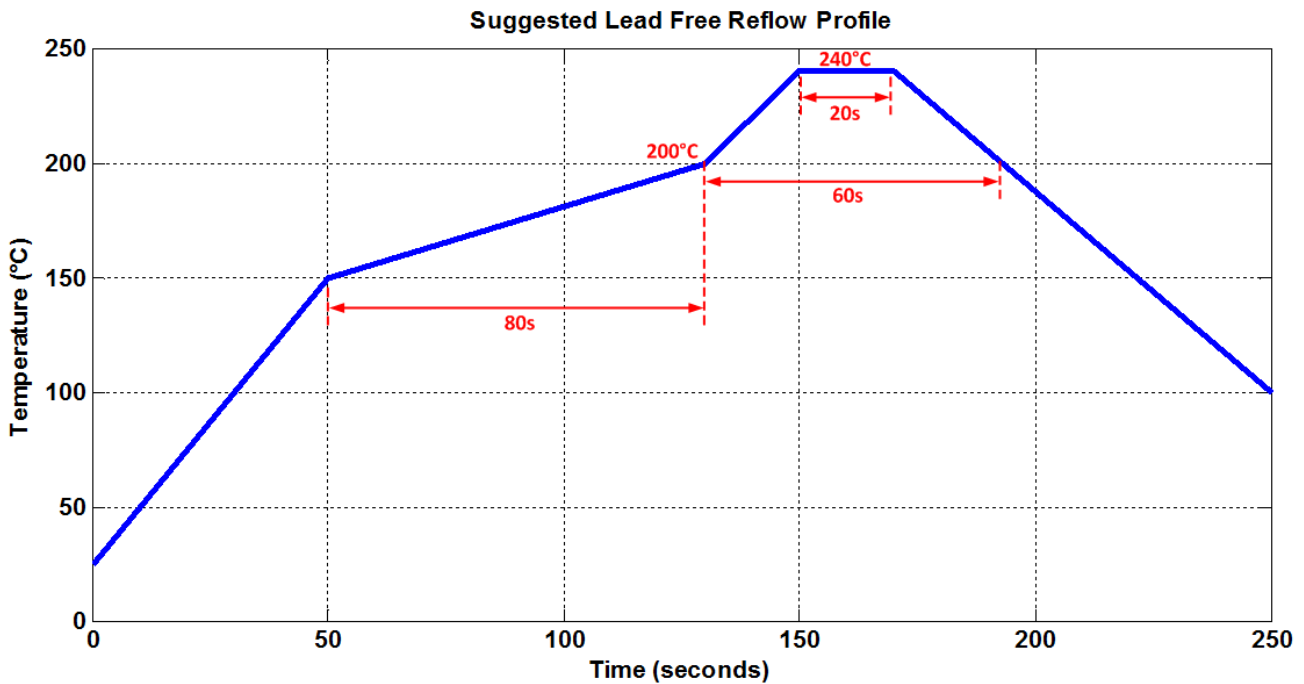

Figure 11. Recommended Soldering Profile

It is important to ensure this temperature profile is measured at the sensor itself. Measuring the profile at a larger component with a higher thermal mass means the temperature at the small sensor will be higher than expected.

For manual soldering, the contact time must be limited to **5 seconds** with a maximum iron temperature of **350°C**.

In either case, a board wash after soldering is **not** recommended. Therefore, if a solder paste is used, it is strongly recommended that a “no-clean” solder paste is used to avoid the need to wash the PCB.

After soldering, the recommended rehydration process should be done. Otherwise, there may be an initial offset in the relative humidity readings, which will slowly disappear as the sensor get exposed to ambient conditions.

Recommended rehydration process:

- A relative humidity of 75% RH at room temperature for at least 12 hours.
- or
- A relative humidity of 40% to 50% RH at room temperature for 3 to 5 days

8. PCB Layout Guide

When designing the PCB, undesired heat transfer paths to the HS41xx must be minimized. Excessive heat from other components on the PCB will result in inaccurate temperature and relative humidity measurements. As such, **solid metal planes for power supplies should be avoided in the vicinity of the sensor** because these will act as thermal conductors. To further reduce the heat transfer from other components on the board, openings can be milled into the PCB as shown in Figure 12.

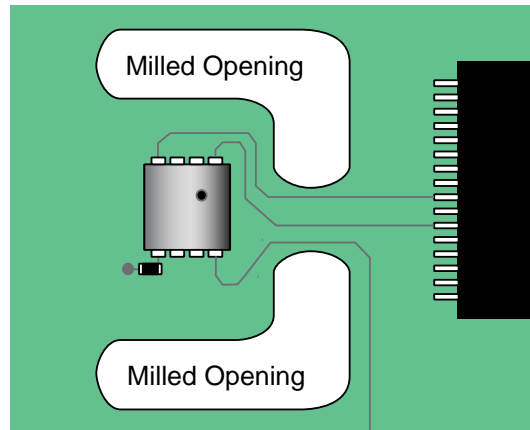

Figure 12. Milled PCB Openings for Thermal Isolation

9. Storage and Handling

Recommendation: Once the sensors are removed from their original packaging, store them in metal-in antistatic bags.

Avoid using polyethylene antistatic bags as they may affect sensor accuracy.

The nominal storage conditions are 10 to 50°C, and humidity levels within 20% to 60%RH. If stored outside of these conditions for extended periods of time, the sensor readings may exhibit an offset. The sensor can be reconditioned and brought back to its calibration state by applying the following procedure:

1. Bake at a temperature of 100°C with a humidity < 10% RH for 10 to 12 hours.
2. Rehydrate the sensor at a humidity of 75% RH and a temperature between 20°C to 30°C for 12 to 14 hours.

10. Quality and Reliability

The HS41xx is available as a qualified product for consumer and industrial market applications. All data specified parameters are guaranteed if not stated otherwise.

11. Package Outline Drawings

The package outline drawings are located at the end of this document and are accessible from the Renesas website. The package information is the most current data available and is subject to change without revision of this document.

12. Marking Diagram

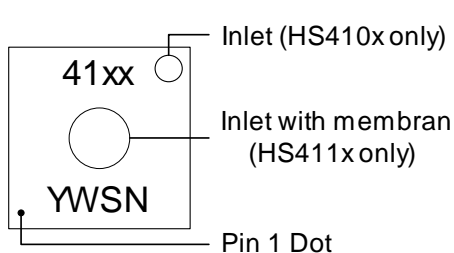

Mark legend:

Line 1: Sensor type (for example, 4111)

Line 2:

First character: Year (for example, 3 = 2023)
 Second character: Week code (for example, X = 31)
 Third and fourth character: Test Release Sequence Number

13. Ordering Information

Part Number	Package Description	Carrier Type	Temperature Range
HS4101	Relative Humidity and Temperature Sensor, Analog Output. ±1.5% RH (Typical), 2.5 × 2.5 × 0.9 mm, 8-LGA	Reel	-40°C to +105°C
HS4103	Relative Humidity and Temperature Sensor, Analog Output. ±2.5% RH (Typical), 2.5 × 2.5 × 0.9 mm, 8-LGA	Reel	-40°C to +105°C
HS4111	Relative Humidity and Temperature Sensor, with Membrane, Analog Output. ±1.5% RH (Typical), 2.5 × 2.5 × 0.9 mm, 8-LGA	Reel	-40°C to +105°C
HS4113	Relative Humidity and Temperature Sensor, with Membrane, Analog Output. ±2.5% RH (Typical), 2.5 × 2.5 × 0.9 mm, 8-LGA	Reel	-40°C to +105°C

14. Revision History

Revision	Date	Description
1.00	Aug 29, 2023	Initial release.

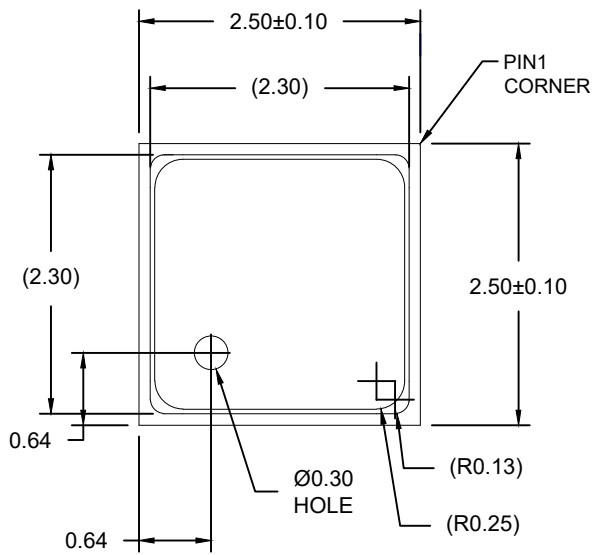

TOP VIEW

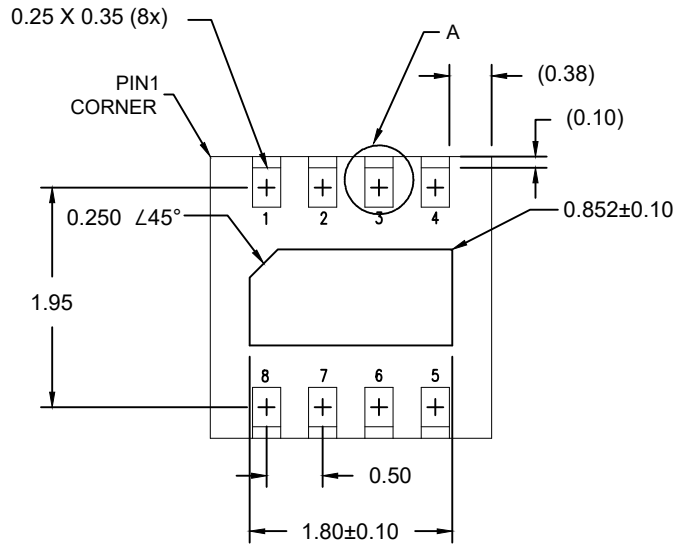

BOTTOM VIEW

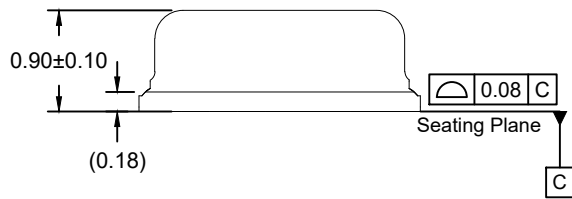

SIDE VIEW

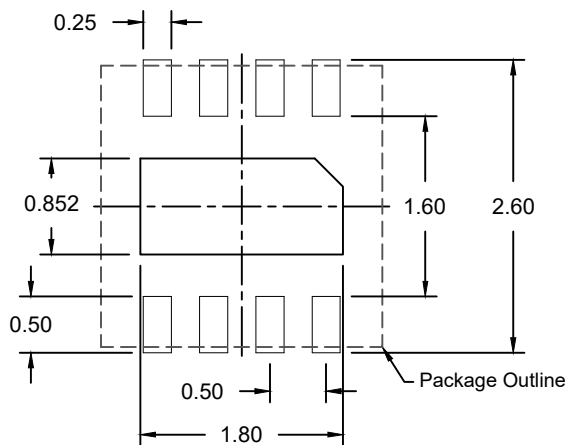
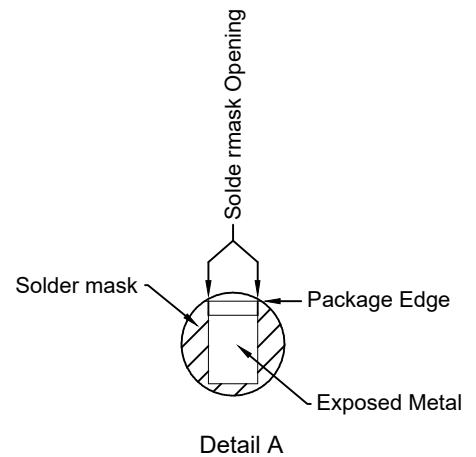

RECOMMENDED LAND PATTERN
(PCB Top View, NSMD Design)

NOTES:

1. JEDEC compatible
2. All dimensions are in mm, angles in degrees.
3. Use ± 0.05 mm for non-toleranced dimensions.
4. Numbers in () are for reference only.

IMPORTANT NOTICE AND DISCLAIMER

RENESAS ELECTRONICS CORPORATION AND ITS SUBSIDIARIES (“RENESAS”) PROVIDES TECHNICAL SPECIFICATIONS AND RELIABILITY DATA (INCLUDING DATASHEETS), DESIGN RESOURCES (INCLUDING REFERENCE DESIGNS), APPLICATION OR OTHER DESIGN ADVICE, WEB TOOLS, SAFETY INFORMATION, AND OTHER RESOURCES “AS IS” AND WITH ALL FAULTS, AND DISCLAIMS ALL WARRANTIES, EXPRESS OR IMPLIED, INCLUDING, WITHOUT LIMITATION, ANY IMPLIED WARRANTIES OF MERCHANTABILITY, FITNESS FOR A PARTICULAR PURPOSE, OR NON-INFRINGEMENT OF THIRD PARTY INTELLECTUAL PROPERTY RIGHTS.

These resources are intended for developers skilled in the art designing with Renesas products. You are solely responsible for (1) selecting the appropriate products for your application, (2) designing, validating, and testing your application, and (3) ensuring your application meets applicable standards, and any other safety, security, or other requirements. These resources are subject to change without notice. Renesas grants you permission to use these resources only for development of an application that uses Renesas products. Other reproduction or use of these resources is strictly prohibited. No license is granted to any other Renesas intellectual property or to any third party intellectual property. Renesas disclaims responsibility for, and you will fully indemnify Renesas and its representatives against, any claims, damages, costs, losses, or liabilities arising out of your use of these resources. Renesas' products are provided only subject to Renesas' Terms and Conditions of Sale or other applicable terms agreed to in writing. No use of any Renesas resources expands or otherwise alters any applicable warranties or warranty disclaimers for these products.

(Disclaimer Rev.1.0 Mar 2020)

Corporate Headquarters

TOYOSU FORESIA, 3-2-24 Toyosu,
Koto-ku, Tokyo 135-0061, Japan
www.renesas.com

Contact Information

For further information on a product, technology, the most up-to-date version of a document, or your nearest sales office, please visit:
www.renesas.com/contact/

Trademarks

Renesas and the Renesas logo are trademarks of Renesas Electronics Corporation. All trademarks and registered trademarks are the property of their respective owners.