

Power Inductor

AHP-SERIES

1. Features

1. This specification applies Low Profile Power Inductors.
2. 100% Lead(Pb) & Halogen-Free and RoHS compliant.
3. Operating temperature :-40~+125°C (Including self - temperature rise)



2. Dimension

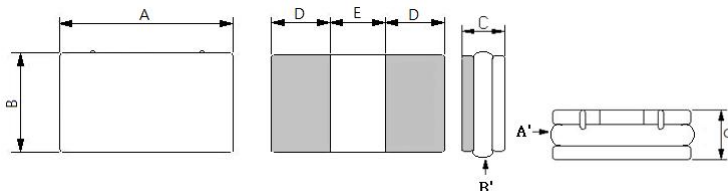

Recommended PC Board Pattern

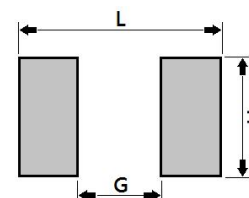

Series	A(mm)	A'(mm)	B(mm)	B'(mm)	C(mm)	D(mm)	E(mm)
AHP121008FA	1.2±0.2	1.5 Max	1.0±0.2	1.3 Max	0.8Max	0.40 ref	0.40 ref
AHP160808FA/RA	1.6±0.2	1.9 Max	0.8±0.2	1.1 Max	0.8 Max	0.50 ref	0.60 ref

Size	L(mm)	G(mm)	H(mm)
160808	1.80	0.60	0.96
32**	3.6	1.2	2.8

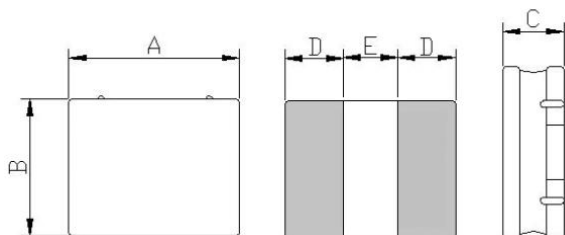

Series	A(mm)	B(mm)	C(mm)	D(mm)	E(mm)
AHP322508RA	3.2±0.2	2.5±0.2	0.8 Max	0.95 ref	1.30 ref
AHP322512RA	3.2±0.2	2.5±0.2	1.2 Max	0.95 ref	1.30 ref

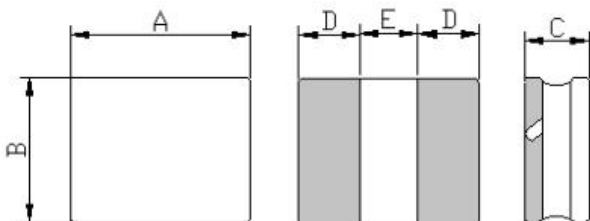
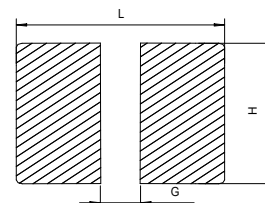

Series	A(mm)	B(mm)	C(mm)	D(mm)	E(mm)
AHP322508FA	3.2 ± 0.2	2.5 ± 0.2	0.8 Max	0.95 ref	1.30 ref
AHP322512FA	3.2±0.2	2.5±0.2	1.2 Max	0.95 ref	1.30 ref

Size	L(mm)	G(mm)	H(mm)
1210**	1.45	0.40	1.20
2012**	2.40	0.60	1.44
2016**FA	2.3	0.8	1.9
2520**FA	2.9	1.0	2.4
2016**RA	2.3	0.6	1.9
2520**RA	2.9	0.8	2.4
30**	3.2	1.0	3.2
4008/4010/4012	4.2	1.2	4.2

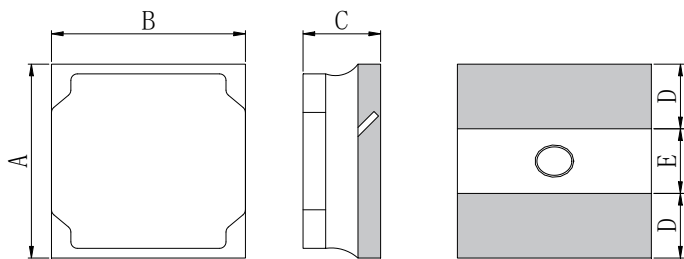

Series	A(mm)	B(mm)	C(mm)	D(mm)	E(mm)
AHP3010HF	3.0±0.2	3.0±0.2	1.0max	1.0 ref	1.0 ref
AHP3012HF	3.0±0.2	3.0±0.2	1.2max	1.0 ref	1.0 ref
AHP4010HF	4.0±0.2	4.0±0.2	1.0 max	1.2 ref	1.6 ref
AHP4012HF	4.0±0.2	4.0±0.2	1.2 max	1.4±0.25	1.2±0.25

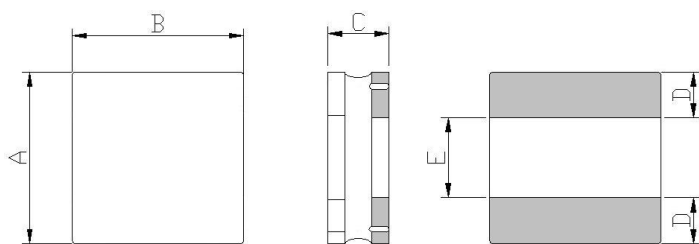

Series	A(mm)	B(mm)	C(mm)	D(mm)	E(mm)
AHP201208RA	2.0±0.2	1.2±0.2	0.80Max	0.50 ref	1.00 ref
AHP4008RA	4.0±0.2	4.0±0.2	0.7±0.1	1.4±0.25	1.2±0.25

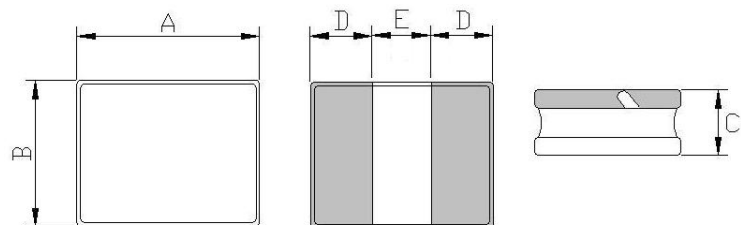

Series	A(mm)	B(mm)	C(mm)	D(mm)	E(mm)
AHP201608FA	2.0 -0.1/+0.2	1.6 -0.1/+0.2	0.8Max	0.50 ref	1.00 ref
AHP201610FA	2.0 -0.1/+0.2	1.6 -0.1/+0.2	1.0Max	0.50 ref	1.00 ref
AHP252010FA	2.5 -0.1/+0.2	2.0 -0.1/+0.2	1.0Max	0.75 ref	1.00 ref
AHP252012FA	2.5 -0.1/+0.2	2.0 -0.1/+0.2	1.2Max	0.75 ref	1.00 ref

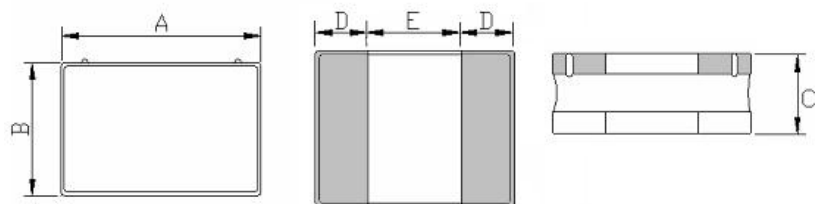

Series	A(mm)	B(mm)	C(mm)	D(mm)	E(mm)
AHP252008RA	2.5 -0.1/+0.2	2.0 -0.1/+0.2	0.8Max	0.75 ref	1.00 ref

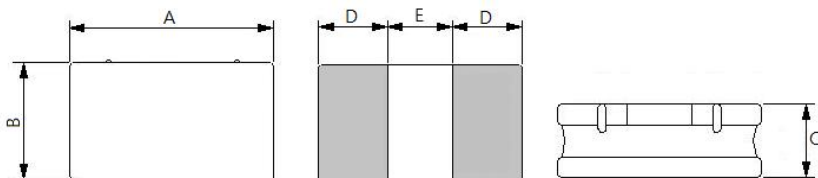

Series	A(mm)	B(mm)	C(mm)	D(mm)	E(mm)
AHP201210RA	2.0 ± 0.2	1.2 ± 0.2	1.0Max	0.50 ref	1.00 ref

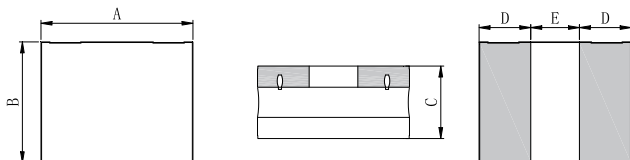

Series	A(mm)	B(mm)	C(mm)	D(mm)	E(mm)
AHP201610RA	2.00±0.20	1.60±0.20	0.90±0.10	0.65±0.20	0.75±0.20
AHP252010RA	2.50±0.20	2.00±0.20	0.90±0.10	0.8±0.20	0.95±0.20
AHP252012RA	2.50±0.20	2.00±0.20	1.10±0.10	0.80±0.20	0.95±0.20

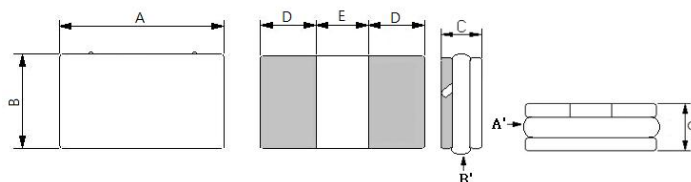

Series	A(mm)	A'(mm)	B(mm)	B'(mm)	C(mm)	D(mm)	E(mm)
AHP201210FA	2.0±0.2	2.3 Max	1.2±0.2	1.5 Max	1.0Max	0.50 ref	1.00 ref

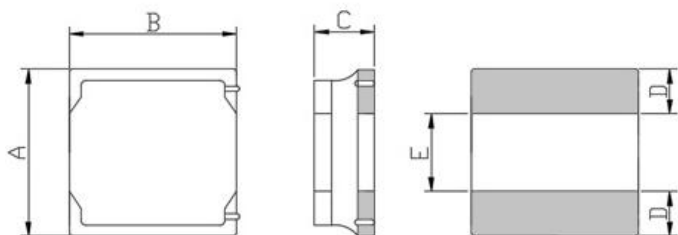

Series	A(mm)	B(mm)	C(mm)	D(mm)	E(mm)
AHP3015RA	3.0±0.2	3.0±0.2	1.5 max	1.0 ref	1.0 ref
AHP3008RA	3.0±0.2	3.0±0.2	0.7±0.1	1.0 ref	1.0 ref

3. Part Numbering

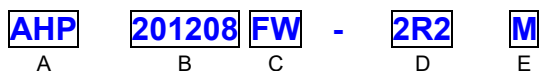

A: Series

B: Dimension

C: Lead Free

D: Inductance

E: Inductance Tolerance

Material

2R2=2.20uH

K=±10%, L=±15%, M=±20%, Y=±30%.

AHP **3010** **HF** - **2R2** **M**
 A B C D E

A: Series

B: Dimension

C: Lead Free

D: Inductance 2R2=2.20uH

E: Inductance Tolerance K=±10%, L=±15%, M=±20%, Y=±30%.

AHP **201610** **FA** - **R24** **M**
 A B C D E

A: Series

B: Dimension

C: Lead Free

D: Inductance Material
R24=0.240uH

E: Inductance Tolerance K=±10%, L=±15%, M=±20%, Y=±30%.

4. Specification

Part Number	Inductance (uH)±20% @ 0 A	Test Frequency (Hz)	DCR (Ω)		I sat (A)		I rms (A)	
			Typ	Max	Typ	Max	Typ	Max
AHP121008RA-R24M	0.24	1V/1M	0.075	0.090	4.00	3.50	2.80	2.30
AHP121008RA-R33M	0.33	1V/1M	0.095	0.114	3.50	3.00	2.50	2.10
AHP121008RA-R47M	0.47	1V/1M	0.120	0.144	3.00	2.50	2.10	1.70
AHP121008RA-R68M	0.68	1V/1M	0.170	0.204	2.00	1.50	1.80	1.50
AHP121008RA-1R0M	1.00	1V/1M	0.190	0.228	1.50	1.20	1.50	1.40
AHP121008RA-1R5M	1.50	1V/1M	0.270	0.324	1.30	1.10	1.30	1.10
AHP121008RA-2R2M	2.20	1V/1M	0.480	0.576	1.25	1.05	1.00	0.85
AHP121008RA-3R3M	3.30	1V/1M	0.750	0.900	1.15	0.90	0.85	0.70
AHP121008RA-4R7M	4.70	1V/1M	1.100	1.320	0.90	0.70	0.65	0.55
AHP121008RA-6R8M	6.80	1V/1M	1.750	2.100	0.65	0.55	0.50	0.45
AHP121008RA-100M	10.0	1V/1M	2.000	2.400	0.50	0.40	0.45	0.40

Part Number	Inductance (uH)±20% @ 0 A	Test Frequency (Hz)	I rms (A)		I sat (A)		DCR (Ω)	
			Typ	Max	Typ	Max	Typ	Max
AHP160808RA-R24M	0.24	1V/1M	2.50	2.10	4.00	3.50	0.070	0.084
AHP160808RA-R33M	0.33	1V/1M	2.20	1.90	3.00	2.50	0.090	0.108
AHP160808RA-R47M	0.47	1V/1M	1.90	1.70	2.60	2.20	0.110	0.132
AHP160808RA-R68M	0.68	1V/1M	1.50	1.30	2.00	1.60	0.180	0.216
AHP160808RA-1R0M	1.00	1V/1M	1.30	1.10	1.80	1.50	0.230	0.276
AHP160808RA-1R5M	1.50	1V/1M	0.80	0.70	1.50	1.20	0.400	0.480
AHP160808RA-2R2M	2.20	1V/1M	0.75	0.65	1.00	0.80	0.450	0.540
AHP160808RA-3R3M	3.30	1V/1M	0.70	0.60	0.90	0.70	0.700	0.840
AHP160808RA-4R7M	4.70	1V/1M	0.55	0.45	0.80	0.60	1.000	1.200
AHP160808RA-6R8M	6.80	1V/1M	0.40	0.35	0.65	0.55	1.800	2.160
AHP160808RA-100M	10.0	1V/1M	0.35	0.30	0.50	0.40	2.100	2.520

Part Number	Inductance (μH) $\pm 20\%$ @ 0 A	Test Frequency (Hz)	I rms (A)		I sat (A)		DCR (Ω)	
			Typ	Max	Typ	Max	Typ	Max
AHP201208RA-R24M	0.24	1V/1M	3.50	3.00	4.50	3.50	0.036	0.043
AHP201208RA-R47M	0.47	1V/1M	2.50	2.00	3.50	2.50	0.060	0.072
AHP201208RA-R68M	0.68	1V/1M	1.80	1.50	3.00	2.00	0.130	0.156
AHP201208RA-1R0M	1.00	1V/1M	1.70	1.40	2.50	1.70	0.170	0.204
AHP201208RA-1R5M	1.50	1V/1M	1.30	1.10	2.20	1.50	0.260	0.312
AHP201208RA-2R2M	2.20	1V/1M	1.00	0.90	1.50	1.20	0.400	0.480
AHP201208RA-3R3M	3.30	1V/1M	0.90	0.80	1.20	1.00	0.480	0.576
AHP201208RA-4R7M	4.70	1V/1M	0.70	0.60	1.10	0.90	0.800	0.960
AHP201208RA-6R8M	6.80	1V/1M	0.60	0.50	0.90	0.80	1.200	1.440
AHP201208RA-100M	10.0	1V/1M	0.45	0.40	0.70	0.60	1.800	2.160

Part Number	Inductance (μH) $\pm 20\%$ @ 0 A	Test Frequency (Hz)	I rms (A)		I sat (A)		DCR (Ω)	
			Typ	Max	Typ	Max	Typ	Max
AHP201210RA-R47M	0.47	1V/1M	2.70	2.40	2.80	2.50	0.050	0.060
AHP201210RA-R68M	0.68	1V/1M	2.40	2.10	2.50	2.20	0.060	0.080
AHP201210RA-1R0M	1.00	1V/1M	1.80	1.50	1.90	1.60	0.090	0.108
AHP201210RA-1R5M	1.50	1V/1M	1.60	1.30	1.80	1.40	0.130	0.156
AHP201210RA-2R2M	2.20	1V/1M	1.50	1.20	1.70	1.30	0.190	0.228
AHP201210RA-3R3M	3.30	1V/1M	1.30	1.10	1.40	1.10	0.290	0.348
AHP201210RA-4R7M	4.70	1V/1M	1.10	0.90	1.00	0.80	0.340	0.408
AHP201210RA-6R8M	6.80	1V/1M	0.95	0.75	0.90	0.70	0.540	0.648
AHP201210RA-100M	10.0	1V/1M	0.65	0.55	0.60	0.50	0.780	0.936
AHP201210RA-220M	22.0	1V/1M	0.50	0.40	0.45	0.35	1.700	2.040

Part Number	Inductance (μH) $\pm 20\%$ @ 0 A	Test Frequency (Hz)	I rms (A)		I sat (A)		DCR (Ω)	
			Typ	Max	Typ	Max	Typ	Max
AHP201608RA-R24M	0.24	1V/1M	4.00	3.50	7.00	6.00	0.040	0.048
AHP201608RA-R33M	0.33	1V/1M	3.50	3.00	6.00	5.00	0.055	0.065
AHP201608RA-R47M	0.47	1V/1M	3.00	2.70	5.00	4.00	0.070	0.084
AHP201608RA-R68M	0.68	1V/1M	2.80	2.50	4.00	3.00	0.085	0.100
AHP201608RA-1R0M	1.00	1V/1M	2.20	1.80	3.00	2.50	0.110	0.130
AHP201608RA-1R5M	1.50	1V/1M	2.00	1.70	2.80	2.30	0.160	0.190
AHP201608RA-2R2M	2.20	1V/1M	1.80	1.40	2.50	2.00	0.220	0.260
AHP201608RA-3R3M	3.30	1V/1M	1.20	1.10	1.80	1.50	0.380	0.450
AHP201608RA-4R7M	4.70	1V/1M	1.10	1.00	1.70	1.40	0.550	0.660
AHP201608RA-6R8M	6.80	1V/1M	0.85	0.75	1.30	1.10	0.780	0.940
AHP201608RA-100M	10.0	1V/1M	0.80	0.70	0.90	0.80	0.800	0.960

Part Number	Inductance (μH) $\pm 20\%$ @ 0 A	I rms (A)		I sat (A)		DCR (Ω)	
		Typ	Max	Typ	Max	Typ	Max
AHP201610RA-R24M	0.24	5.60	5.00	7.00	6.00	0.021	0.0252
AHP201610RA-R33M	0.33	5.10	4.60	5.50	5.00	0.028	0.0336
AHP201610RA-R47M	0.47	4.50	4.00	4.80	4.40	0.041	0.0492
AHP201610RA-R68M	0.68	3.80	3.40	4.00	3.50	0.055	0.066
AHP201610RA-1R0M	1.00	3.10	2.80	3.60	3.10	0.075	0.090
AHP201610RA-1R5M	1.50	2.40	2.10	3.10	2.70	0.115	0.138
AHP201610RA-2R2M	2.20	1.90	1.60	2.40	2.10	0.170	0.204
AHP201610RA-3R3M	3.30	1.50	1.30	1.60	1.30	0.190	0.218
AHP201610RA-4R7M	4.70	1.30	1.10	1.40	1.20	0.320	0.384

Part Number	Inductance (μH) $\pm 20\%$ @ 0 A	Test Frequency (Hz)	I rms (A)		I sat (A)		DCR (Ω)	
			Typ	Max	Typ	Max	Typ	Max
AHP252008RA-R24M	0.24	1V/1M	4.50 (1) 4.70 (2)	4.00 (1) 4.20 (2)	5.30	4.80	0.035	0.042
AHP252008RA-R33M	0.33	1V/1M	3.90 (1) 4.30 (2)	3.50 (1) 3.90 (2)	4.80	4.30	0.040	0.055
AHP252008RA-R47M	0.47	1V/1M	3.70 (1) 4.10 (2)	3.30 (1) 3.70 (2)	4.50	4.00	0.045	0.060
AHP252008RA-R68M	0.68	1V/1M	3.50 (1) 3.70 (2)	3.00 (1) 3.20 (2)	4.00	3.50	0.060	0.075
AHP252008RA-1R0M	1.00	1V/1M	2.80 (1) 3.20 (2)	2.50 (1) 2.80 (2)	3.20	2.80	0.070	0.090
AHP252008RA-1R5M	1.50	1V/1M	2.30 (1) 2.50 (2)	2.10 (1) 2.30 (2)	2.80	2.60	0.105	0.127
AHP252008RA-2R2M	2.20	1V/1M	1.80 (1) 2.20 (2)	1.60 (1) 1.80 (2)	2.00	1.80	0.150	0.180
AHP252008RA-3R3M	3.30	1V/1M	1.60 (1) 1.80 (2)	1.30 (1) 1.50 (2)	1.60	1.30	0.220	0.260
AHP252008RA-4R7M	4.70	1V/1M	1.20 (1) 1.30 (2)	1.00 (1) 1.10 (2)	1.50	1.20	0.360	0.430

Part Number	Inductance (μH) $\pm 20\%$ @ 0 A	Test Frequency (Hz)	I rms (A)		I sat (A)		DCR (Ω)	
			Typ	Max	Typ	Max	Typ	Max
AHP3008RA-R24M	0.24	1V100K	4.50	4.00	8.00	7.00	0.040	0.048
AHP3008RA-R33M	0.33	1V100K	4.00	3.50	7.00	6.00	0.050	0.060
AHP3008RA-R47M	0.47	1V100K	3.40	3.00	6.00	5.00	0.075	0.090
AHP3008RA-R68M	0.68	1V100K	3.10	2.70	5.50	4.50	0.090	0.108
AHP3008RA-1R0M	1.00	1V100K	2.80	2.50	5.00	4.00	0.100	0.120
AHP3008RA-1R5M	1.50	1V100K	2.60	2.30	4.50	3.50	0.120	0.144
AHP3008RA-2R2M	2.20	1V100K	1.95	1.70	4.00	3.00	0.210	0.252
AHP3008RA-3R3M	3.30	1V100K	1.60	1.40	3.00	2.50	0.320	0.384
AHP3008RA-4R7M	4.70	1V100K	1.40	1.10	1.70	1.50	0.360	0.410
AHP3008RA-6R8M	6.80	1V100K	1.30	1.00	1.60	1.40	0.400	0.460
AHP3008RA-100M	10.0	1V100K	1.00	0.90	1.50	1.30	0.860	0.980

Part Number	Inductance (μH) $\pm 20\%$ @ 0 A	Test Frequency (Hz)	I rms (A)		I sat (A)		DCR (Ω)	
			Typ	Max	Typ	Max	Typ	Max
AHP322508RA-R24M	0.24	1V/1M	6.00	5.00	8.00	7.00	0.025	0.030
AHP322508RA-R33M	0.33	1V/1M	5.50	4.50	7.00	6.00	0.035	0.042
AHP322508RA-R47M	0.47	1V/1M	4.30	3.80	6.00	5.00	0.050	0.060
AHP322508RA-R68M	0.68	1V/1M	3.80	3.30	5.50	4.50	0.065	0.078
AHP322508RA-1R0M	1.00	1V/1M	3.30	3.00	5.00	4.00	0.085	0.102
AHP322508RA-1R5M	1.50	1V/1M	2.80	2.50	4.50	3.50	0.110	0.132
AHP322508RA-2R2M	2.20	1V/1M	2.30	2.00	4.00	3.00	0.170	0.204
AHP322508RA-3R3M	3.30	1V/1M	2.00	1.70	3.00	2.00	0.250	0.300
AHP322508RA-4R7M	4.70	1V/1M	1.50	1.30	2.80	1.80	0.380	0.456
AHP322508RA-6R8M	6.80	1V/1M	1.30	1.10	2.50	1.50	0.530	0.636
AHP322508RA-100M	10.0	1V/1M	1.10	0.90	1.80	1.30	0.760	0.912

Part Number	Inductance (μH) $\pm 20\%$ @ 0 A	Test Frequency (Hz)	I rms (A)		I sat (A)		DCR (Ω)	
			Typ	Max	Typ	Max	Typ	Max
AHP322512RA-R47M	0.47	1V/1M	5.00	4.50	8.00	7.00	0.030	0.036
AHP322512RA-R68M	0.68	1V/1M	4.70	4.20	6.80	6.00	0.035	0.042
AHP322512RA-1R0M	1.00	1V/1M	4.00	3.50	5.50	4.80	0.042	0.051
AHP322512RA-1R5M	1.50	1V/1M	3.50	3.00	4.50	4.00	0.065	0.078
AHP322512RA-2R2M	2.20	1V/1M	2.80	2.50	3.50	3.00	0.090	0.108
AHP322512RA-3R3M	3.30	1V/1M	2.20	1.80	2.80	2.50	0.140	0.168
AHP322512RA-4R7M	4.70	1V/1M	1.70	1.50	2.50	2.20	0.200	0.240
AHP322512RA-6R8M	6.80	1V/1M	1.50	1.30	2.20	1.80	0.290	0.350
AHP322512RA-100M	10.0	1V/1M	1.30	1.00	1.50	1.20	0.350	0.420
AHP322512RA-330M	33.0	1V/1M	0.60	0.50	1.10	0.90	1.40	1.68

Part Number	Inductance (μH) $\pm 20\%$ @ 0 A	Test Frequency (Hz)	I rms (A)		I sat (A)		DCR (Ω)	
			Typ	Max	Typ	Max	Typ	Max
AHP4008RA-R47M	0.47	1V/100K	3.50	3.00	6.00	5.00	0.060	0.072
AHP4008RA-R68M	0.68	1V/100K	3.20	2.70	5.00	4.00	0.080	0.096
AHP4008RA-1R0M	1.00	1V/100K	3.00	2.50	4.00	3.50	0.100	0.120
AHP4008RA-1R5M	1.50	1V/100K	2.60	2.30	3.50	3.00	0.125	0.150
AHP4008RA-2R2M	2.20	1V/100K	2.30	2.00	3.00	2.70	0.150	0.180
AHP4008RA-3R3M	3.30	1V/100K	2.00	1.70	2.70	2.50	0.220	0.260
AHP4008RA-4R7M	4.70	1V/100K	1.70	1.50	2.50	2.30	0.300	0.360
AHP4008RA-6R8M	6.80	1V/100K	1.40	1.20	2.30	2.10	0.500	0.600
AHP4008RA-100M	100	1V/100K	1.20	1.00	2.10	1.90	0.700	0.840

Part Number	Inductance (μ H) \pm 20% @ 0 A	Test Frequency (Hz)	I rms (A)		I sat (A)		DCR (Ω)	
			Typ	Max	Typ	Max	Typ	Max
AHP201610HF-R24M	0.24	1V/1M	5.60 (1) 5.90 (2)	5.00 (1) 5.30 (2)	7.00	6.00	0.017	0.021
AHP201610HF-R33M	0.33	1V/1M	5.10 (1) 5.30 (2)	4.60 (1) 4.80 (2)	5.50	5.00	0.023	0.029
AHP201610HF-R47M	0.47	1V/1M	4.50 (1) 4.80 (2)	4.00 (1) 4.40 (2)	5.20	4.30	0.028	0.035
AHP201610HF-R68M	0.68	1V/1M	3.80 (1) 4.00 (2)	3.40 (1) 3.60 (2)	4.30	3.70	0.040	0.050
AHP201610HF-1R0M	1.00	1V/1M	3.10 (1) 3.50 (2)	2.80 (1) 3.20 (2)	3.60	3.00	0.053	0.065
AHP201610HF-1R5M	1.50	1V/1M	2.40 (1) 2.70 (2)	2.10 (1) 2.30 (2)	2.60	2.30	0.100	0.120
AHP201610HF-2R2M	2.20	1V/1M	2.10 (1) 2.20 (2)	1.90 (1) 2.00 (2)	2.10	1.90	0.110	0.130
AHP201610HF-3R3M	3.30	1V/1M	1.50 (1) 1.70 (2)	1.30 (1) 1.50 (2)	1.50	1.30	0.180	0.216
AHP201610HF-4R7M	4.70	1V/1M	1.10 (1) 1.20 (2)	1.00 (1) 1.10 (2)	1.10	1.00	0.190	0.230

Part Number	Inductance (μ H) \pm 20% @ 0 A	Test Frequency (Hz)	I rms (A)		I sat (A)		DCR (Ω)	
			Typ	Max	Typ	Max	Typ	Max
AHP252010HF-R16M	0.16	1V/1M	6.00 (1) 6.50 (2)	5.50 (1) 6.00 (2)	8.50	7.50	0.015	0.020
AHP252010HF-R24M	0.24	1V/1M	5.50 (1) 6.00 (2)	5.00 (1) 5.50 (2)	7.20	6.70	0.022	0.028
AHP252010HF-R33M	0.33	1V/1M	4.80 (1) 5.00 (2)	4.30 (1) 4.50 (2)	6.00	5.50	0.023	0.029
AHP252010HF-R47M	0.47	1V/1M	4.50 (1) 4.70 (2)	3.90 (1) 4.20 (2)	5.50	4.90	0.029	0.035
AHP252010HF-R56M	0.56	1V/1M	3.90 (1) 4.10 (2)	3.50 (1) 3.70 (2)	4.50	4.00	0.035	0.042
AHP252010HF-R68M	0.68	1V/1M	3.80 (1) 4.00 (2)	3.40 (1) 3.60 (2)	4.40	3.80	0.036	0.043
AHP252010HF-R82M	0.82	1V/1M	3.60 (1) 3.80 (2)	3.10 (1) 3.30 (2)	3.80	3.20	0.043	0.052
AHP252010HF-1R0M	1.00	1V/1M	3.50 (1) 3.70 (2)	3.00 (1) 3.20 (2)	3.60	3.10	0.044	0.053
AHP252010HF-1R2M	1.20	1V/1M	2.60 (1) 2.90 (2)	2.30 (1) 2.50 (2)	3.50	3.00	0.070	0.084
AHP252010HF-1R5M	1.50	1V/1M	2.50 (1) 2.80 (2)	2.20 (1) 2.40 (2)	3.20	2.70	0.072	0.086
AHP252010HF-1R8M	1.80	1V/1M	2.50 (1) 2.70 (2)	2.20 (1) 2.40 (2)	2.70	2.30	0.088	0.106
AHP252010HF-2R2M	2.20	1V/1M	2.40 (1) 2.60 (2)	2.10 (1) 2.30 (2)	2.50	2.10	0.090	0.108
AHP252010HF-3R3M	3.30	1V/1M	1.50 (1) 1.70 (2)	1.30 (1) 1.50 (2)	2.00	1.70	0.190	0.230
AHP252010HF-4R7M	4.70	1V/1M	1.40 (1) 1.60 (2)	1.20 (1) 1.40 (2)	1.70	1.40	0.220	0.264

Part Number	Inductance (μ H) \pm 20% @ 0 A	Test Frequency (Hz)	I rms (A)		I sat (A)		DCR (Ω)	
			Typ	Max	Typ	Max	Typ	Max
AHP252012HF-R24M	0.24	1V/1M	7.00 (1) 7.50 (2)	6.00 (1) 6.50 (2)	7.80	6.50	0.011	0.015
AHP252012HF-R33M	0.33	1V/1M	5.80 (1) 6.30 (2)	4.80 (1) 5.20 (2)	7.00	6.00	0.017	0.023
AHP252012HF-R47M	0.47	1V/1M	5.00 (1) 5.50 (2)	4.20 (1) 4.70 (2)	6.50	5.50	0.021	0.027
AHP252012HF-R68M	0.68	1V/1M	4.50 (1) 5.00 (2)	3.90 (1) 4.20 (2)	6.00	5.00	0.030	0.037
AHP252012HF-1R0M	1.00	1V/1M	4.00 (1) 4.50 (2)	3.50 (1) 4.00 (2)	4.50	3.80	0.036	0.044
AHP252012HF-1R5M	1.50	1V/1M	3.50 (1) 4.00 (2)	3.00 (1) 3.50 (2)	3.80	3.20	0.050	0.060
AHP252012HF-2R2M	2.20	1V/1M	2.60 (1) 3.00 (2)	2.20 (1) 2.50 (2)	2.60	2.20	0.070	0.084
AHP252012HF-3R3M	3.30	1V/1M	2.00 (1) 2.20 (2)	1.80 (1) 2.00 (2)	2.30	2.00	0.115	0.140
AHP252012HF-4R7M	4.70	1V/1M	1.70 (1) 1.90 (2)	1.50 (1) 1.70 (2)	1.70	1.50	0.125	0.150

Part Number	Inductance (μH) $\pm 20\%$ @ 0 A	Test Frequency (Hz)	I rms (A)		I sat (A)		DCR (Ω)	
			Typ	Max	Typ	Max	Typ	Max
AHP3010HF-R47M	0.47	1V/1M	4.000	3.500	6.800	5.800	0.033	0.039
AHP3010HF-R68M	0.68	1V/1M	3.800	3.000	6.000	5.000	0.048	0.058
AHP3010HF-1R0M	1.00	1V/1M	3.000	2.500	5.300	4.600	0.068	0.080
AHP3010HF-1R5M	1.50	1V/1M	2.800	2.300	4.000	3.500	0.087	0.100
AHP3010HF-2R2M	2.20	1V/1M	2.300	2.000	3.200	2.700	0.115	0.135
AHP3010HF-3R3M	3.30	1V/1M	1.800	1.500	2.500	2.200	0.210	0.238
AHP3010HF-4R7M	4.70	1V/1M	1.600	1.300	2.200	1.900	0.265	0.315
AHP3010HF-6R8M	6.80	1V/1M	1.300	1.100	1.700	1.400	0.300	0.360
AHP3010HF-100M	10.0	1V/1M	1.100	1.000	1.300	1.100	0.360	0.420

Part Number	Inductance (μH) $\pm 20\%$ @ 0 A	Test Frequency (Hz)	I rms (A)		I sat (A)		DCR (Ω)	
			Typ	Max	Typ	Max	Typ	Max
AHP3012HF-R33M	0.33	1V/1M	5.50	4.50	9.00	7.00	0.020	0.024
AHP3012HF-R47M	0.47	1V/1M	5.20	4.20	7.50	6.50	0.025	0.030
AHP3012HF-R68M	0.68	1V/1M	4.50	3.70	6.50	5.50	0.032	0.038
AHP3012HF-1R0M	1.00	1V/1M	4.00	3.50	5.20	4.50	0.042	0.049
AHP3012HF-1R5M	1.50	1V/1M	3.50	3.00	4.50	4.00	0.060	0.072
AHP3012HF-2R2M	2.20	1V/1M	2.80	2.30	3.60	3.00	0.090	0.108
AHP3012HF-3R3M	3.30	1V/1M	2.10	1.70	3.00	2.50	0.130	0.156
AHP3012HF-4R7M	4.70	1V/1M	1.80	1.50	2.60	2.30	0.180	0.216
AHP3012HF-6R8M	6.80	1V/1M	1.50	1.30	2.20	1.90	0.250	0.300
AHP3012HF-100M	10.0	1V/1M	1.40	1.20	1.50	1.30	0.290	0.350

Part Number	Inductance (μH) $\pm 20\%$ @ 0 A	Test Frequency (Hz)	I rms (A)		I sat (A)		DCR (Ω)	
			Typ	Max	Typ	Max	Typ	Max
AHP4010HF-R47M	0.47	1V/100K	4.50	4.00	8.00	7.00	0.038	0.045
AHP4010HF-R68M	0.68	1V/100K	4.00	3.50	7.00	6.00	0.050	0.060
AHP4010HF-1R0M	1.00	1V/100K	3.50	3.20	6.00	5.00	0.059	0.069
AHP4010HF-1R5M	1.50	1V/100K	3.50	3.00	4.00	3.50	0.062	0.075
AHP4010HF-2R2M	2.20	1V/100K	3.00	2.50	3.10	2.60	0.075	0.090
AHP4010HF-3R3M	3.30	1V/100K	2.50	2.00	2.80	2.30	0.115	0.140
AHP4010HF-4R7M	4.70	1V/100K	2.10	1.70	2.50	2.00	0.200	0.240
AHP4010HF-6R8M	6.80	1V/100K	1.60	1.40	2.10	1.80	0.300	0.360
AHP4010HF-100M	10.0	1V/100K	1.40	1.20	1.80	1.50	0.440	0.510

Part Number	Inductance (μH) $\pm 20\%$ @ 0 A	Test Frequency (Hz)	I rms (A)		I sat (A)		DCR (Ω)	
			Typ	Max	Typ	Max	Typ	Max
AHP4012HF-R47M	0.47	1V100K	6.00	5.00	10.00	8.00	0.028	0.033
AHP4012HF-R68M	0.68	1V100K	5.00	4.00	8.00	7.00	0.036	0.043
AHP4012HF-1R0M	1.00	1V100K	3.80	3.50	6.50	5.50	0.040	0.050
AHP4012HF-1R5M	1.50	1V100K	3.70	3.30	5.60	4.70	0.050	0.060
AHP4012HF-2R2M	2.20	1V100K	3.40	3.00	4.50	4.00	0.065	0.078
AHP4012HF-3R3M	3.30	1V100K	2.80	2.50	4.00	3.30	0.100	0.120
AHP4012HF-4R7M	4.70	1V100K	2.30	2.00	3.00	2.70	0.125	0.145
AHP4012HF-6R8M	6.80	1V100K	2.10	1.80	2.20	1.90	0.150	0.180
AHP4012HF-100M	10.0	1V100K	1.60	1.40	2.00	1.70	0.280	0.330

Part Number	Inductance (μH) $\pm 20\%$ @ 0 A	Test Frequency (Hz)	I rms (A)		I sat (A)		DCR (Ω)	
			Typ	Max	Typ	Max	Typ	Max
AHP160808FA-R24M	0.24	1V/1M	2.00	1.80	4.50	4.00	0.075	0.090
AHP160808FA-R33M	0.33	1V/1M	1.60	1.50	4.00	3.50	0.090	0.108
AHP160808FA-R47M	0.47	1V/1M	1.30	1.20	3.50	3.00	0.100	0.120
AHP160808FA-R56M	0.56	1V/1M	1.10	0.90	3.00	2.50	0.110	0.132

Part Number	Inductance (μH) $\pm 20\%$ @ 0 A	Test Frequency (Hz)	DCR (Ω)		I sat (A)		I rms (A)	
			Typ	Max	Typ	Max	Typ	Max
AHP121008FA-R24M	0.24	1V/1M	0.040	0.048	4.00	3.50	3.50	3.00
AHP121008FA-R33M	0.33	1V/1M	0.050	0.060	3.30	2.80	3.00	2.60
AHP121008FA-R47M	0.47	1V/1M	0.070	0.084	2.80	2.30	2.60	2.20
AHP121008FA-R68M	0.68	1V/1M	0.100	0.120	2.30	1.80	2.20	1.90
AHP121008FA-1R0M	1.00	1V/1M	0.145	0.174	2.00	1.60	1.60	1.40

Part Number	Inductance (μH) $\pm 20\%$ @ 0 A	Test Frequency (Hz)	I rms (A)		I sat (A)		DCR (Ω)	
			Typ	Max	Typ	Max	Typ	Max
AHP201208FA-R24M	0.24	1V/1M	4.70	4.20	4.50	4.00	0.028	0.033
AHP201208FA-R33M	0.33	1V/1M	4.30	3.80	3.50	3.00	0.036	0.043
AHP201208FA-R47M	0.47	1V/1M	4.00	3.50	3.30	2.80	0.045	0.054
AHP201208FA-R68M	0.68	1V/1M	3.30	2.80	3.10	2.60	0.065	0.078
AHP201208FA-1R0M	1.00	1V/1M	2.30	2.10	2.50	2.00	0.100	0.120
AHP201208FA-1R5M	1.50	1V/1M	2.00	1.70	2.20	1.90	0.150	0.180
AHP201208FA-2R2M	2.20	1V/1M	1.60	1.40	1.90	1.60	0.210	0.250
AHP201208FA-3R3M	3.30	1V/1M	1.50	1.30	1.20	1.00	0.240	0.288

Note:

Inductance Test Frequency 1MHz/1V

Heat Rated Current (I rms) will cause the coil temperature rise approximately ΔT of 40°C

Saturation Current (I sat) will cause L0 to drop approximately 30%.

Rated DC current: The lower value of I rms and I sat.

Part Number	Inductance (μH) $\pm 20\%$ @ 0 A	Test Frequency (Hz)	I rms (A)		I sat (A)		DCR (Ω)	
			Typ	Max	Typ	Max	Typ	Max
AHP201210FA-R24M	0.24	1V/1M	5.40	4.60	6.00	5.00	0.022	0.028
AHP201210FA-R33M	0.33	1V/1M	4.70	4.10	4.50	3.50	0.028	0.034
AHP201210FA-R47M	0.47	1V/1M	4.30	3.70	4.20	3.30	0.033	0.042
AHP201210FA-R68M	0.68	1V/1M	3.80	3.30	3.20	3.00	0.045	0.054
AHP201210FA-1R0M	1.00	1V/1M	2.30	2.10	2.50	2.00	0.069	0.078
AHP201210FA-1R5M	1.50	1V/1M	2.00	1.70	2.20	1.90	0.150	0.180
AHP201210FA-2R2M	2.20	1V/1M	1.60	1.40	1.90	1.60	0.210	0.250
AHP201210FA-3R3M	3.30	1V/1M	1.50	1.30	1.20	1.00	0.240	0.288

Part Number	Inductance (μH) $\pm 20\%$ @ 0 A	Test Frequency (Hz)	DCR (Ω)		I sat (A)		I rms (A)	
			Typ	Max	Typ	Max	Typ	Max
AHP201608FA-R24M	0.24	1V/1M	0.030	0.036	6.50	5.00	4.50	4.00
AHP201608FA-R33M	0.33	1V/1M	0.035	0.042	5.50	4.50	4.00	3.50
AHP201608FA-R47M	0.47	1V/1M	0.045	0.054	4.50	3.50	3.50	3.20
AHP201608FA-R68M	0.68	1V/1M	0.060	0.072	3.80	3.30	3.00	2.70
AHP201608FA-1R0M	1.00	1V/1M	0.076	0.087	3.30	2.80	2.80	2.50
AHP201608FA-1R5M	1.50	1V/1M	0.100	0.115	2.50	2.20	2.40	2.10
AHP201608FA-2R2M	2.20	1V/1M	0.150	0.180	2.30	2.00	2.00	1.70
AHP201608FA-3R3M	3.30	1V/1M	0.250	0.300	1.80	1.50	1.50	1.30
AHP201608FA-4R7M	4.70	1V/1M	0.340	0.408	1.40	1.10	1.30	1.10
AHP201608FA-6R8M	6.80	1V/1M	0.500	0.600	1.30	1.00	1.00	0.90

Part Number	Inductance (μH) $\pm 20\%$ @ 0 A	Test Frequency (Hz)	I rms (A)		I sat (A)		DCR (Ω)	
			Typ	Max	Typ	Max	Typ	Max
AHP201610FA-R24M	0.24	1V/1M	5.70 (1) 6.50 (2)	5.10 (1) 5.50 (2)	7.50	6.50	0.015	0.020
AHP201610FA-R33M	0.33	1V/1M	5.50 (1) 5.60 (2)	5.00 (1) 5.20 (2)	5.50	5.00	0.018	0.023
AHP201610FA-R47M	0.47	1V/1M	4.70 (1) 5.30 (2)	4.30 (1) 4.70 (2)	5.20	4.50	0.024	0.029
AHP201610FA-R68M	0.68	1V/1M	3.90 (1) 4.20 (2)	3.50 (1) 3.80 (2)	5.10	4.40	0.036	0.044
AHP201610FA-1R0M	1.00	1V/1M	3.20 (1) 3.40 (2)	2.90 (1) 3.10 (2)	4.50	4.00	0.050	0.060
AHP201610FA-1R5M	1.50	1V/1M	2.90 (1) 3.10 (2)	2.50 (1) 2.70 (2)	3.20	2.80	0.068	0.082
AHP201610FA-2R2M	2.20	1V/1M	2.20 (1) 2.30 (2)	2.00 (1) 2.10 (2)	2.70	2.40	0.100	0.120
AHP201610FA-3R3M	3.30	1V/1M	1.80(1) 2.00(2)	1.60(1) 1.80(2)	2.00	1.70	0.160	0.192
AHP201610FA-4R7M	4.70	1V/1M	1.60 (1) 1.80 (2)	1.40 (1) 1.60 (2)	1.60	1.40	0.180	0.216

TAI-TECH Part Number	Inductance (μ H)	Test Frequency (Hz)	I rms (A)		I sat (A)		DCR (Ω)	
			Typ	Max	Typ	Max	Typ	Max
AHP252008FA-R24M	0.24	1V/1M	4.80	4.30	6.00	5.00	0.028	0.033
AHP252008FA-R33M	0.33	1V/1M	4.30	3.80	5.50	4.50	0.033	0.039
AHP252008FA-R47M	0.47	1V/1M	3.80	3.30	5.00	4.00	0.040	0.048
AHP252008FA-R68M	0.68	1V/1M	3.20	2.80	4.80	3.80	0.055	0.066
AHP252008FA-1R0M	1.00	1V/1M	2.90	2.60	3.80	3.30	0.065	0.078
AHP252008FA-1R5M	1.50	1V/1M	2.60	2.30	3.30	2.80	0.090	0.108
AHP252008FA-2R2M	2.20	1V/1M	2.30	2.00	2.50	2.00	0.120	0.144
AHP252008FA-3R3M	3.30	1V/1M	2.00	1.70	2.30	1.80	0.200	0.240
AHP252008FA-4R7M	4.70	1V/1M	1.70	1.40	1.80	1.50	0.260	0.312
AHP252008FA-6R8M	6.80	1V/1M	1.40	1.20	1.50	1.20	0.380	0.456
AHP252008FA-100M	10.0	1V/1M	1.10	0.90	1.10	0.90	0.570	0.684

TAI-TECH Part Number	Inductance (μ H)	Test Frequency (Hz)	I rms (A)		I sat (A)		DCR (Ω)	
			Typ	Max	Typ	Max	Typ	Max
AHP252010FA-R24M	0.24	1V/1M	5.50 (1) 6.00 (2)	5.00 (1) 5.50 (2)	9.50	8.00	0.018	0.022
AHP252010FA-R33M	0.33	1V/1M	5.30 (1) 5.60 (2)	4.80 (1) 5.10 (2)	8.00	6.50	0.023	0.028
AHP252010FA-R47M	0.47	1V/1M	4.60 (1) 5.30 (2)	4.20 (1) 4.80 (2)	7.00	5.90	0.027	0.035
AHP252010FA-R68M	0.68	1V/1M	4.20 (1) 4.40 (2)	3.80 (1) 4.00 (2)	5.50	4.60	0.032	0.040
AHP252010FA-1R0M	1.00	1V/1M	3.50 (1) 3.70 (2)	3.10 (1) 3.40 (2)	4.90	4.30	0.044	0.053
AHP252010FA-1R5M	1.50	1V/1M	3.20 (1) 3.40 (2)	2.80 (1) 3.00 (2)	3.80	3.10	0.062	0.074
AHP252010FA-2R2M	2.20	1V/1M	2.60 (1) 2.80 (2)	2.30 (1) 2.50 (2)	2.80	2.30	0.078	0.093
AHP252010FA-4R7M	4.70	1V/1M	1.70 (1) 1.80 (2)	1.50 (1) 1.60 (2)	1.70	1.40	0.180	0.216

TAI-TECH Part Number	Inductance (μ H)	Test Frequency (Hz)	I rms (A)		I sat (A)		DCR (Ω)	
			Typ	Max	Typ	Max	Typ	Max
AHP252012FA-R33M	0.33	1V/1M	5.50(1) 6.50(2)	5.00(1) 5.50(2)	8.00	7.20	0.016	0.021
AHP252012FA-R47M	0.47	1V/1M	5.00(1) 6.00(2)	4.50(1) 5.00(2)	7.40	6.70	0.017	0.023
AHP252012FA-R68M	0.68	1V/1M	4.30(1) 5.00(2)	3.80(1) 4.50(2)	5.50	4.90	0.027	0.032
AHP252012FA-1R0M	1.00	1V/1M	3.90(1) 4.50(2)	3.30(1) 3.80(2)	5.30	4.70	0.034	0.040
AHP252012FA-1R5M	1.50	1V/1M	3.50(1) 4.00(2)	3.00(1) 3.50(2)	4.50	3.90	0.050	0.060
AHP252012FA-2R2M	2.20	1V/1M	2.60(1) 3.00(2)	2.20(1) 2.60(2)	3.40	3.00	0.070	0.084
AHP252012FA-3R3M	3.30	1V/1M	1.40(1) 1.60(2)	1.20(1) 1.40(2)	1.50	1.30	0.085	0.100

TAI-TECH Part Number	Inductance (μ H)	Test Frequency (Hz)	I rms (A)		I sat (A)		DCR (Ω)	
			Typ	Max	Typ	Max	Typ	Max
AHP322512FA-R47M	0.47	1V/1M	5.40	4.80	8.00	7.00	0.019	0.025
AHP322512FA-R68M	0.68	1V/1M	4.90	4.40	7.20	6.20	0.026	0.032
AHP322512FA-1R0M	1.00	1V/1M	4.30	3.80	6.00	5.00	0.032	0.038
AHP322512FA-1R5M	1.50	1V/1M	3.50	3.00	4.80	4.20	0.042	0.052
AHP322512FA-2R2M	2.20	1V/1M	3.10	2.80	4.30	3.80	0.060	0.072
AHP322512FA-3R3M	3.30	1V/1M	2.40	2.10	2.80	2.30	0.100	0.120
AHP322512FA-4R7M	4.70	1V/1M	2.10	1.80	2.30	2.00	0.135	0.163
AHP322512FA-6R8M	6.80	1V/1M	1.80	1.50	2.10	1.80	0.190	0.228
AHP322512FA-100M	10.0	1V/1M	1.50	1.20	1.80	1.50	0.300	0.360

TAI-TECH Part Number	Inductance (μ H)	I rms (A)		I sat (A)		DCR (Ω)	
		Typ	Max	Typ	Max	Typ	Max
AHP252010RA-R24M	0.24	5.5	5.0	7.5	7.0	0.022	0.028
AHP252010RA-R33M	0.33	4.8	4.3	6.0	5.5	0.025	0.030
AHP252010RA-R47M	0.47	4.3	3.8	5.5	4.9	0.035	0.040
AHP252010RA-R56M	0.56	4.0	3.6	4.8	4.2	0.040	0.048
AHP252010RA-R68M	0.68	3.8	3.4	4.4	3.8	0.045	0.054
AHP252010RA-1R0M	1.00	3.3	2.8	3.6	3.1	0.062	0.071
AHP252010RA-1R2M	1.20	2.9	2.6	3.2	2.8	0.070	0.080
AHP252010RA-1R5M	1.50	2.7	2.4	2.9	2.6	0.080	0.090
AHP252010RA-2R2M	2.20	2.3	2.0	2.4	2.1	0.120	0.132
AHP252010RA-3R3M	3.30	1.7	1.4	2.1	1.8	0.190	0.216
AHP252010RA-4R7M	4.70	1.4	1.2	1.7	1.4	0.245	0.276

TAI-TECH Part Number	Inductance (μ H)	Test Frequency (Hz)	I rms (A)		I sat (A)		DCR (Ω)	
			Typ	Max	Typ	Max	Typ	Max
AHP3015RA-R47M	0.47	1V/100K	5.50	4.50	10.00	8.00	0.030	0.036
AHP3015RA-R68M	0.68	1V/100K	5.00	4.00	9.00	7.00	0.035	0.042
AHP3015RA-1R0M	1.00	1V/100K	4.50	3.50	6.00	5.00	0.040	0.048
AHP3015RA-1R5M	1.50	1V/100K	3.50	3.00	4.50	4.00	0.055	0.066
AHP3015RA-2R2M	2.20	1V/100K	3.00	2.50	4.20	3.70	0.068	0.082
AHP3015RA-3R3M	3.30	1V/100K	2.50	2.00	4.00	3.50	0.120	0.140
AHP3015RA-4R7M	4.70	1V/100K	2.30	1.80	3.50	3.00	0.160	0.190
AHP3015RA-6R8M	6.80	1V/100K	2.00	1.50	2.70	2.20	0.210	0.260
AHP3015RA-100M	10.0	1V/100K	1.50	1.20	1.90	1.60	0.350	0.420

TAI-TECH Part Number	Inductance (μ H)	I rms (A)		I sat (A)		DCR (Ω)	
		Typ	Max	Typ	Max	Typ	Max
AHP252012RA-R24M	0.24	5.50 (1) 6.00 (2)	5.00 (1) 5.50 (2)	8.0	7.0	0.018	0.022
AHP252012RA-R33M	0.33	5.10 (1) 5.60 (2)	4.60 (1) 5.10 (2)	7.0	6.0	0.023	0.028
AHP252012RA-R47M	0.47	4.80 (1) 5.30 (2)	4.30 (1) 4.80 (2)	6.0	5.0	0.027	0.035
AHP252012RA-R68M	0.68	4.00 (1) 4.50 (2)	3.60 (1) 4.00 (2)	5.0	4.5	0.036	0.045
AHP252012RA-1R0M	1.00	3.50 (1) 3.80 (2)	3.20 (1) 3.50 (2)	4.3	3.8	0.045	0.058
AHP252012RA-1R5M	1.50	3.10 (1) 3.50 (2)	2.70 (1) 3.10 (2)	3.5	3.0	0.060	0.072
AHP252012RA-2R2M	2.20	2.50 (1) 2.80 (2)	2.20 (1) 2.50 (2)	3.1	2.6	0.090	0.108
AHP252012RA-3R3M	3.30	2.10 (1) 2.50 (2)	1.80 (1) 2.20 (2)	2.2	1.9	0.125	0.150
AHP252012RA-4R7M	4.70	1.70 (1) 1.90 (2)	1.40 (1) 1.60 (2)	2.0	1.7	0.190	0.220
AHP252012RA-6R8M	6.80	1.20 (1) 1.30 (2)	1.00 (1) 1.10 (2)	1.8	1.5	0.300	0.360
AHP252012RA-100M	10.0	1.00 (1) 1.10 (2)	0.90 (1) 1.00 (2)	1.4	1.1	0.420	0.475
AHP252012RA-150M	15.0	0.80 (1) 0.90 (2)	0.70 (1) 0.80 (2)	1.05	0.9	0.620	0.700
AHP252012RA-220M	22.0	0.60 (1) 0.70 (2)	0.50 (1) 0.60 (2)	0.8	0.7	0.890	1.000

Note:

Inductance Test Frequency 1MHz/1V

Heat Rated Current (I_{rms}) will cause the coil temperature rise approximately ΔT of 40°C

Saturation Current (I_{sat}) will cause L₀ to drop approximately 30%.

Rated DC current: The lower value of I_{rms} and I_{sat}.

I_{rms} Testing

temperature rise is highly dependent on many factors including pcb land pattern, Circuit design, component placement, frequency, cooling system, trace size, and proximity to other components.....etc. There fore temperature rise should be verified in application conditions.

Measurement board data

I_{rms}1

Material : FR4

Board dimensions : 100 X 50 X 1.6t mm

Pattern dimensions: 45 X 30 mm (Double side board)

Pattern thickness : 50 μ m

I_{rms}2

Material: FR4

Board dimensions : 100 X 50 X 1.6t mm

Pattern dimensions: 45 X 45 mm (Double side board)

Pattern thickness : 70 μ m

5. Material List

No.	Description	Specification
a.	Core	Metal Core
b.	Wire	Enameled Copper Wire
c.	Glue	Epoxy with magnetic powder
d.	Terminal	Ag/Ni/Sn

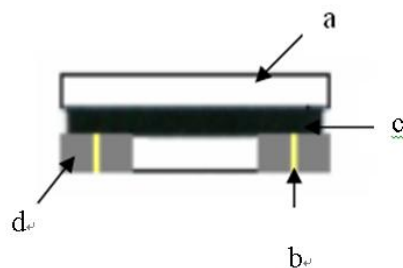

6. Packaging Information

6-1. Reel Dimension

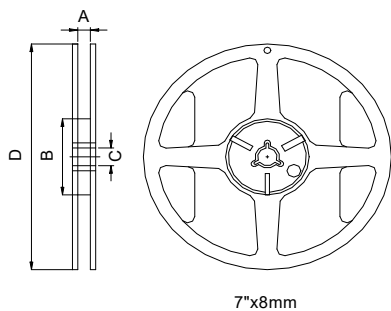

Size	Type	A(mm)	B(mm)	C(mm)	D(mm)
12**/16**/20** /25**/30**	7"x8mm	8.4±1.0	50 min	13±0.8	178±2

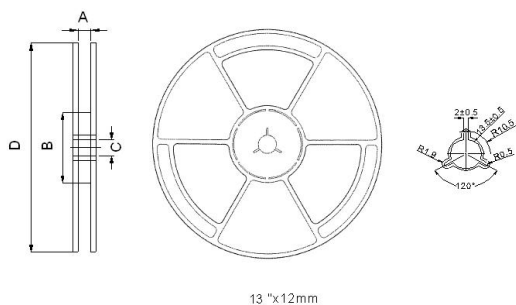

Size	Type	A(mm)	B(mm)	C(mm)	D(mm)
40**	13"x12mm	12.0±1.5	100±0.5	13.2±0.5	330±0.5

6-2. Tape Dimension and Packaging Quantity(mm)

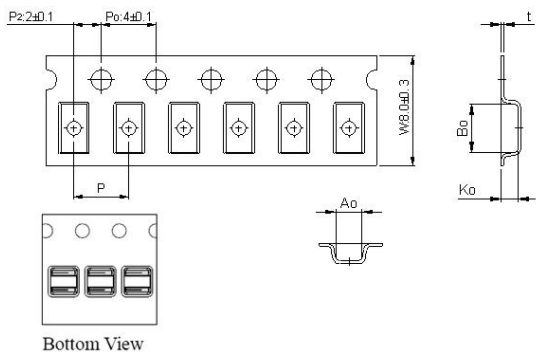

Size	Bo(mm)	Ao(mm)	Ko(mm)	P(mm)	t(mm)	W(mm)
201208	2.35±0.10	1.5±0.10	0.95±0.10	4.00±0.1	0.30±0.05	8.0±0.3
3010	3.2±0.05	3.2±0.05	1.20±0.20	4.0±0.05	0.23±0.05	8.0±0.3
3012	3.2±0.05	3.2±0.05	1.40±0.20	4.0±0.05	0.23±0.05	8.0±0.3
4008	4.15±0.10	4.15±0.10	0.95±0.10	8.0±0.10	0.3±0.05	12.0±0.3
4010/12	4.35±0.10	4.50±0.10	1.55±0.10	8.0±0.10	0.25±0.05	12.0±0.3
201208	2.35±0.10	1.50±0.10	0.95±0.10	4.00±0.10	0.30±0.05	8.0±0.3
201610	2.50±0.10	2.0±0.10	1.40±0.10	4.0±0.10	0.23±0.05	8.0±0.3
252010	3.10±0.10	2.45±0.10	1.40±0.10	4.0±0.10	0.23±0.05	8.0±0.3
322512	3.50±0.10	2.80±0.10	1.34±0.10	4.00±0.10	0.23±0.05	8.0±0.10
201608	2.30±0.1	1.95±0.1	0.95±0.1	4.00±0.1	0.30±0.05	8.0±0.3
3008	3.15±0.1	3.15±0.1	0.95±0.1	4.0±0.10	0.23±0.05	8.0±0.1

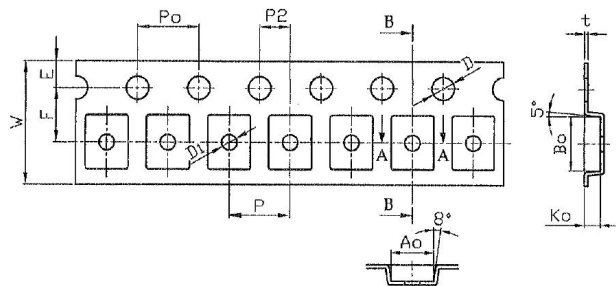

Series	Size	Bo(mm)	Ao(mm)	Ko(mm)	P(mm)	W(mm)	E(mm)	F(mm)	P2(mm)	Po(mm)	D(mm)	D1(mm)	t(mm)
AHP	322508	3.51±0.10	2.79±0.10	1.07±0.10	4.00±0.10	8.00±0.10	1.75±0.10	3.50±0.05	2.00±0.05	4.00±0.10	1.50+0.10-0.00	1.00±0.10	0.23±0.05

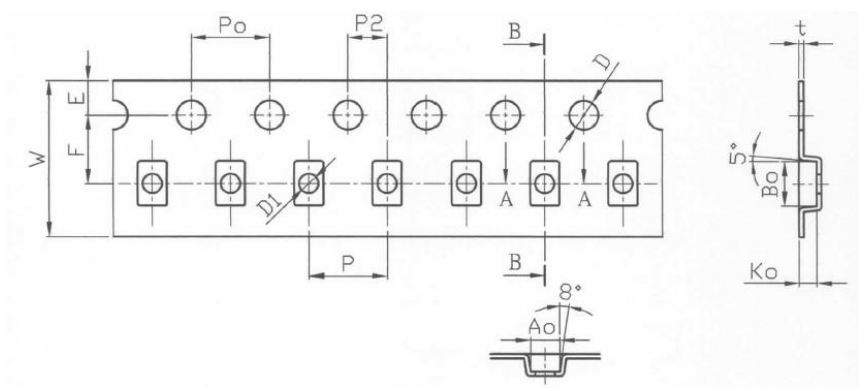

Series	Size	Bo(mm)	Ao(mm)	Ko(mm)	P(mm)	W(mm)	E(mm)	F(mm)	P2(mm)	Po(mm)	D(mm)	D1(mm)	t(mm)
AHP	201208	2.30±0.10	1.50±0.10	0.90±0.10	4.00±0.10	8.00±0.10	1.75±0.10	3.50±0.05	2.00±0.05	4.00±0.10	1.50+0.10-0.00	1.00±0.10	0.23±0.05

6-3. Packaging Quantity

Chip size	121008	160808	201208	201210	30**	3225**	4008	4012
Chip / Reel	3000	3000	4000	2000	2000	2000	5000	4500

6-4. Tearing Off Force

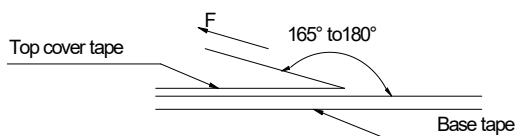

The force for tearing off cover tape is 10 to 100 grams in the arrow direction under the following conditions (referenced ANSI/EIA-481-D-2008 of 4.11 standard).

Tearing Speed mm	Room Temp. (°C)	Room Humidity (%)	Room atm (hPa)
300±10%	5~35	45~85	860~1060

7. Reliability and Test Condition

Item	Performance	Test Condition
Operating temperature	-40~+125°C (Including self - temperature rise)	
Storage temperature	1. -10~+40°C, 50~60%RH (Product with taping) 2. -40~+125°C (on board)	
Electrical Performance Test		
Inductance	Refer to standard electrical characteristics list.	HP4284A, CH11025, CH3302, CH1320, CH1320S LCR Meter.
DCR		CH16502, Agilent33420A Micro-Ohm Meter.
Saturation Current (Isat)	Approximately ΔL 30%.	Saturation DC Current (Isat) will cause L0 to drop ΔL (%)
Heat Rated Current (Irms)	Approximately ΔT 40°C	Heat Rated Current (Irms) will cause the coil temperature rise ΔT (°C) without core loss. 1. Applied the allowed DC current 2. Temperature measured by digital surface thermometer
Reliability Test		
Life Test	Appearance: No damage. Inductance: within $\pm 10\%$ of initial value Q: Shall not exceed the specification value. RDC: within $\pm 15\%$ of initial value and shall not exceed the specification value	Preconditioning: Run through IR reflow for 3 times. (IPC/JEDEC J-STD-020E Classification Reflow Profiles) Temperature: 125 \pm 2°C (Inductor + ambient + temp rise) Applied current: rated current Duration: 1000 \pm 12hrs Measured at room temperature after placing for 24 \pm 2 hrs
Load Humidity		Preconditioning: Run through IR reflow for 3 times. (IPC/JEDEC J-STD-020E Classification Reflow Profiles) Humidity: 85 \pm 2% R.H. Temperature: 85°C \pm 2°C Duration: 1000hrs Min. Bead: with 100% rated current, Inductance: with 100% rated current Measured at room temperature after placing for 24 \pm 2 hrs.
Moisture Resistance		Preconditioning: Run through IR reflow for 3 times. (IPC/JEDEC J-STD-020E Classification Reflow Profiles) 1. Baked at 50°C for 25hrs, measured at room temperature after placing for 4 hrs. 2. Raise temperature to 65 \pm 2°C 90-100%RH in 2.5hrs, and keep 3 hours, cool down to 25°C in 2.5hrs. 3. Raise temperature to 65 \pm 2°C 90-100%RH in 2.5hrs, and keep 3 hours, cool down to 25°C in 2.5hrs, keep at 25°C for 2 hrs then keep at -10°C for 3 hrs 4. Keep at 25°C 80-100%RH for 15min and vibrate at the frequency of 10 to 55 Hz to 10 Hz, measure at room temperature after placing for 1~2 hrs.
Thermal shock		Preconditioning: Run through IR reflow for 3 times. (IPC/JEDEC J-STD-020E Classification Reflow Profiles) Condition for 1 cycle Step1: -40 \pm 2°C 30 \pm 5min Step2: 125 \pm 2°C \leq 0.5min Step3: 125 \pm 2°C 30 \pm 5min Number of cycles: 500 Measured at room temperature after placing for 24 \pm 2 hrs.
Vibration		Preconditioning: Run through IR reflow for 3 times. (IPC/JEDEC J-STD-020E Classification Reflow Profiles) Oscillation Frequency: 10Hz~2KHz~10Hz for 20 minutes Equipment: Vibration checker Total Amplitude: 10g Testing Time: 12 hours (20 minutes, 12 cycles each of 3 orientations).

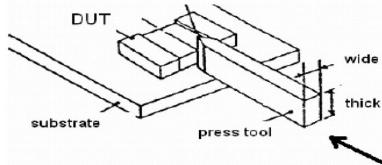
Item	Performance	Test Condition															
Bending	Appearance : No damage.	Shall be mounted on a FR4 substrate of the following dimensions: >=0805 inch(2012mm):40x100x1.2mm <0805 inch(2012mm):40x100x0.8mm Bending depth: >=0805 inch(2012mm):1.2mm <0805 inch(2012mm):0.8mm duration of 10 sec.															
Shock	Inductance : within±10% of initial value Q : Shall not exceed the specification value. RDC : within ±15% of initial value and shall not exceed the specification value	<table border="1" data-bbox="991 376 1428 510"> <thead> <tr> <th>Type</th> <th>Peak value (g's)</th> <th>Normal duration (D) (ms)</th> <th>Wave form</th> <th>Velocity change (V)ft/sec</th> </tr> </thead> <tbody> <tr> <td>SMD</td> <td>50</td> <td>11</td> <td>Half-sine</td> <td>11.3</td> </tr> <tr> <td>Lead</td> <td>50</td> <td>11</td> <td>Half-sine</td> <td>11.3</td> </tr> </tbody> </table> shocks in each direction along 3 perpendicular axes(18 shocks).	Type	Peak value (g's)	Normal duration (D) (ms)	Wave form	Velocity change (V)ft/sec	SMD	50	11	Half-sine	11.3	Lead	50	11	Half-sine	11.3
Type	Peak value (g's)	Normal duration (D) (ms)	Wave form	Velocity change (V)ft/sec													
SMD	50	11	Half-sine	11.3													
Lead	50	11	Half-sine	11.3													
Solderability	More than 95% of the terminal electrode should be covered with solder.	a. Method B1, 4 hrs @155°C dry heat @255°C±5°C Test time:5 +0/-0.5 seconds. b. Method D category 3. (steam aging 8hours ± 15 min)@ 260°C±5°C Test time: 30 +0/-0.5 seconds.															
Resistance to Soldering Heat		Depth: completely cover the termination <table border="1" data-bbox="991 757 1428 884"> <thead> <tr> <th>Temperature(°C)</th> <th>Time(s)</th> <th>Temperature ramp/immersion and emersion rate</th> <th>Number of heat cycles</th> </tr> </thead> <tbody> <tr> <td>260 ±5 (solder temp)</td> <td>10 ±1</td> <td>25mm/s ±6 mm/s</td> <td>1</td> </tr> </tbody> </table>	Temperature(°C)	Time(s)	Temperature ramp/immersion and emersion rate	Number of heat cycles	260 ±5 (solder temp)	10 ±1	25mm/s ±6 mm/s	1							
Temperature(°C)	Time(s)	Temperature ramp/immersion and emersion rate	Number of heat cycles														
260 ±5 (solder temp)	10 ±1	25mm/s ±6 mm/s	1														
Terminal Strength	Appearance : No damage. Inductance : within±10% of initial value Q : Shall not exceed the specification value. RDC : within ±15% of initial value and shall not exceed the specification value e	Preconditioning: Run through IR reflow for 3 times.(IPC/JEDEC J-STD-020E Classification Reflow Profiles With the component mounted on a PCB with the device to be tested, apply a force (>0805inch(2012mm):1kg, <=0805inch(2012mm):0.5kg) to the side of a device being tested. This force shall be applied for 60 +1 seconds. Also the force shall be applied gradually as not to apply a shock to the component being tested. 															

Note : When there are questions concerning measurement result : measurement shall be made after 48 ± 2 hours of recovery under the standard condition.

8.Soldering Specifications

(1) Soldering

Mildly activated rosin fluxes are preferred. TAI-TECH terminations are suitable for re-flow soldering systems. If hand soldering cannot be avoided, the preferred technique is the utilization of hot air soldering tools.

(2) Soldering Reflow:

Recommended temperature profiles for lead free re-flow soldering in Figure 1. Table 1.1&1.2 (J-STD-020E)

(3) Iron Reflow:

Products attachment with a soldering iron is discouraged due to the inherent process control limitations. In the event that a soldering iron must be employed the following precautions are recommended.(Fig. 2)

- Preheat circuit and products to 150°C
- Never contact the ceramic with the iron tip
- Use a 20 watt soldering iron with tip diameter of 1.0mm
- 355°C tip temperature (max)
- 1.0mm tip diameter (max)
- Limit soldering time to 4~5sec.

Fig.1 Soldering Reflow

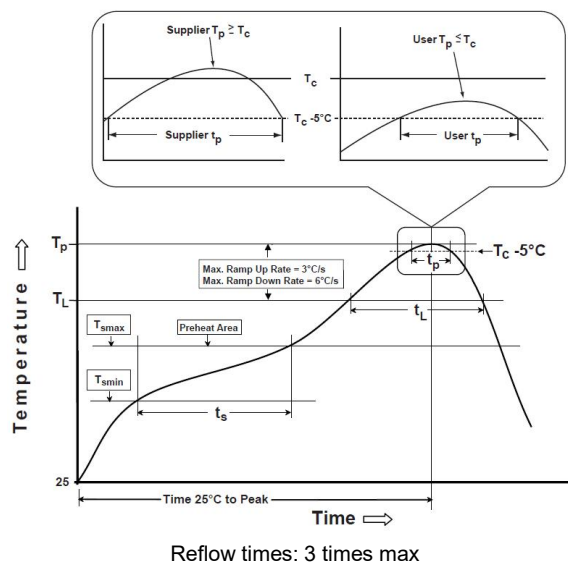

Fig.2 Iron soldering temperature profiles

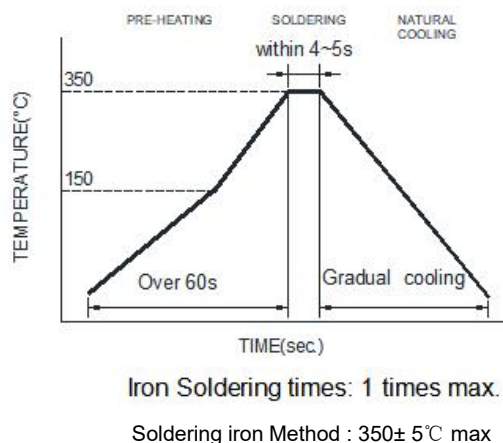

Table (1.1): Reflow Profiles

Profile Type:	Pb-Free Assembly
Preheat	
-Temperature Min(T_{smin})	150°C
-Temperature Max(T_{smax})	200°C
-Time(t_s)from(T_{smin} to T_{smax})	60-120seconds
Ramp-up rate(T_L to T_p)	3°C/second max.
Liquidus temperature(T_L)	217°C
Time(t_L)maintained above T_L	60-150 seconds
Classification temperature(T_c)	See Table (1.2)
Time(t_p) at $T_c - 5^\circ C$ (T_p should be equal to or less than T_c .)	* < 30 seconds
Ramp-down rate(T_p to T_L)	6°C /second max.
Time 25°C to peak temperature	8 minutes max.

T_p : maximum peak package body temperature, T_c : the classification temperature.

For user (customer) T_p should be equal to or less than T_c .

* Tolerance for peak profile temperature (T_p) is defined as a supplier minimum and a user maximum.

Table (1.2) Package Thickness/Volume and Classification Temperature (T_c)

	Package Thickness	Volume mm ³ <350	Volume mm ³ 350-2000	Volume mm ³ >2000
PB-Free Assembly	<1.6mm	260°C	260°C	260°C
	1.6-2.5mm	260°C	250°C	245°C
	≥2.5mm	250°C	245°C	245°C

Reflow is referred to standard IPC/JEDEC J-STD-020E ◦

9. Notes

- (1) When there are questions concerning measurement result : measurement shall be made after 48 ± 2 hours of recovery under the standard condition
- (2) This power choke coil itself does not have any protective function in abnormal condition such as overload, short-circuit and open-circuit conditions, etc. Therefore, it shall be confirmed as the end product that there is no risk of smoking, fire, dielectric withstand voltage, insulation resistance, etc. in abnormal conditions to provide protective devices and/or protection circuit in the end product.
- (3) When this power choke coil was used in a similar or new product to the original one, sometimes it might not be able to satisfy the specifications due to different condition of use.
- (4) Dielectric withstanding test with higher voltage than specific value will damage insulating material and shorten its life.
- (5) This power choke coil must not be used in wet condition by water, coffee or any liquid because insulation strength becomes very low in this condition.
- (6) Please consult our company to confirm the reliability of the process required to wash or use or exposure to a chemical solvent used in this product. PCB washing tested to MIL-STD-202 Method and dry it off immediately 。
- (7) The rated current as listed is either the saturation current or the heating current depending on which value is lower.
- (8) If this power choke is dipped in the cleaning agent, such as toluene, xylene, ketone, and ether system, there is a possibility that the performance decreases greatly, and marking disappears.
- (9) The high power ultrasonic washing may damage the choke body 。
- (10) Before use, the user should determine whether this product is suitable for their own design. Our company only guarantees that the product meets the requirements of this specification 。

Application Notice

- Storage Conditions

To maintain the solderability of terminal electrodes:

1. TAI-TECH products meet IPC/JEDEC J-STD-020E standard-MSL, level 1.
2. Temperature and humidity conditions: Less than 40°C and 60% RH.
3. Recommended products should be used within 12 months from the time of delivery.
4. The packaging material should be kept where no chlorine or sulfur exists in the air.

- Transportation

1. Products should be handled with care to avoid damage or contamination from perspiration and skin oils.
2. The use of tweezers or vacuum pick up is strongly recommended for individual components.
3. Bulk handling should ensure that abrasion and mechanical shock are minimized.

10. Typical Performance Curves

AHP121008RA

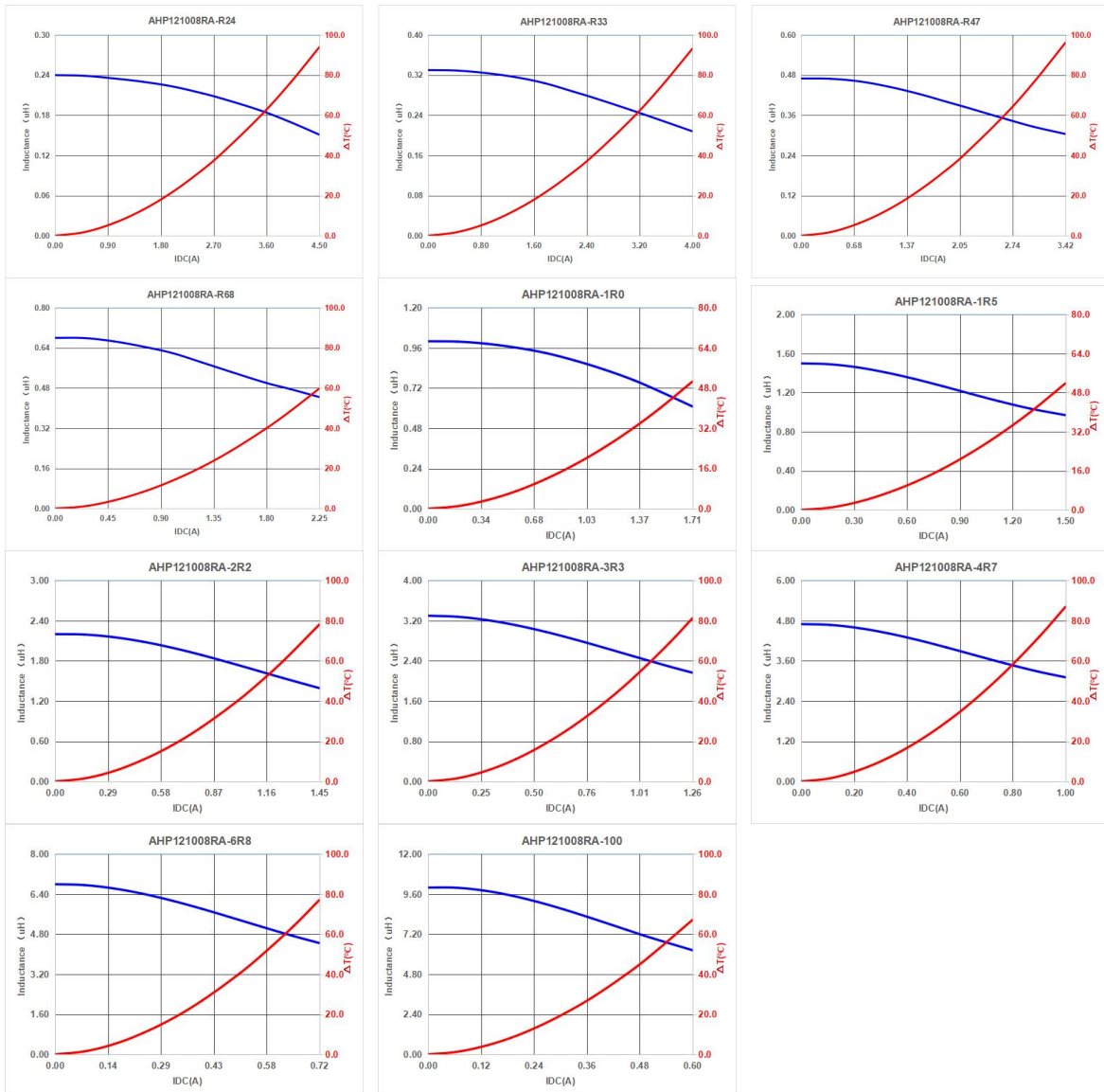

AHP160808RA

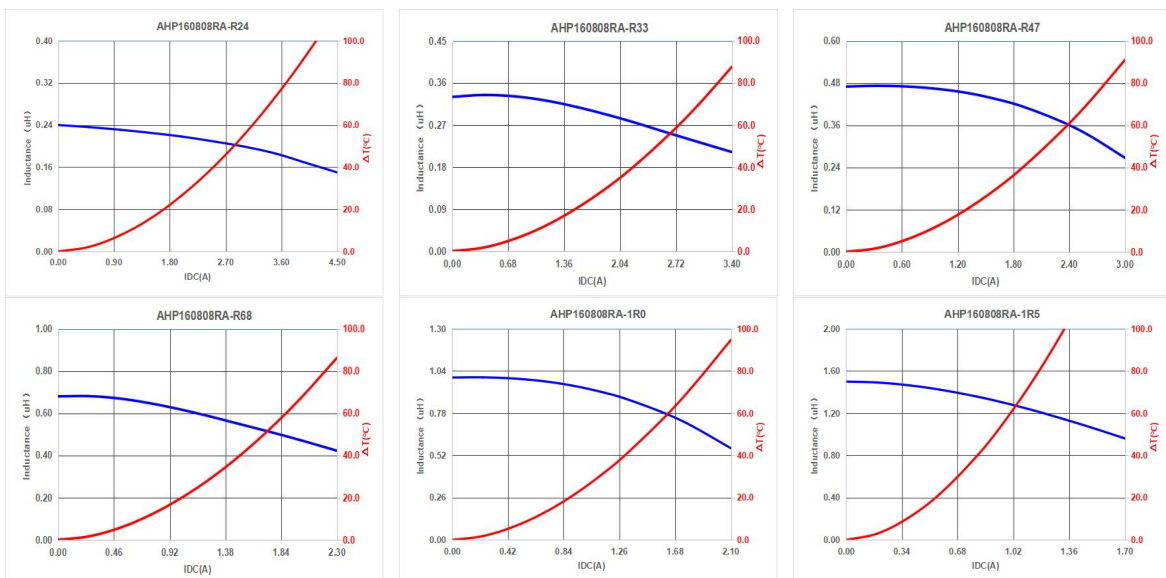

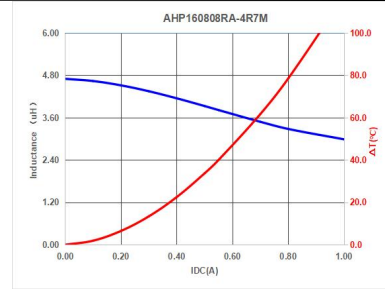
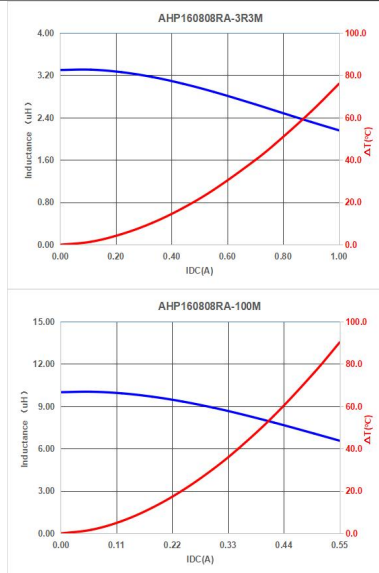
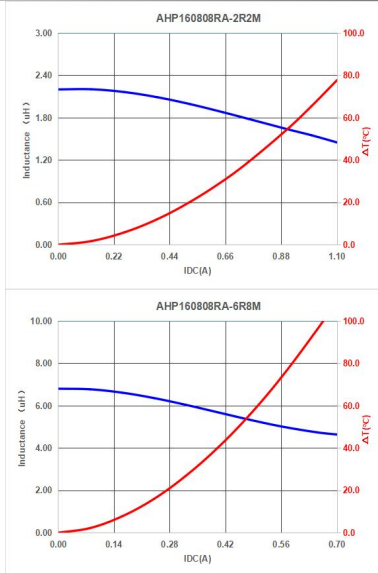

AHP201208RA

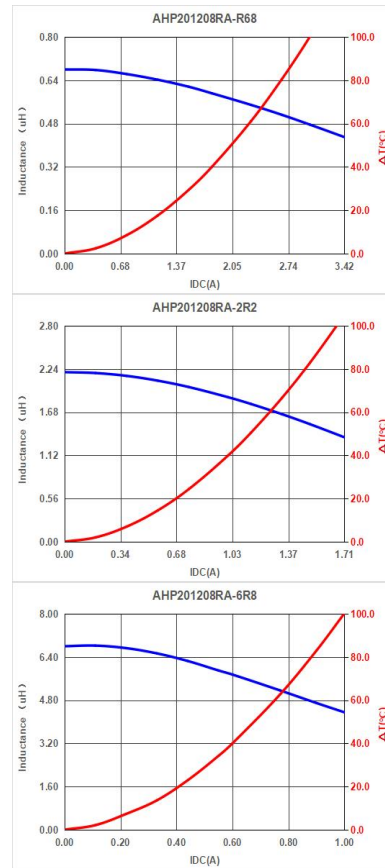
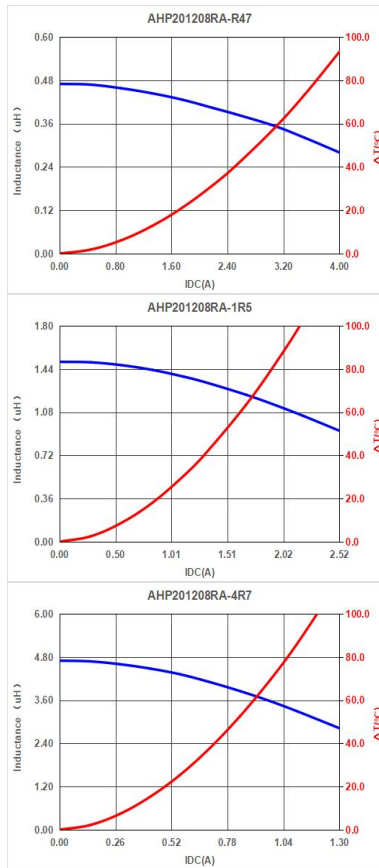
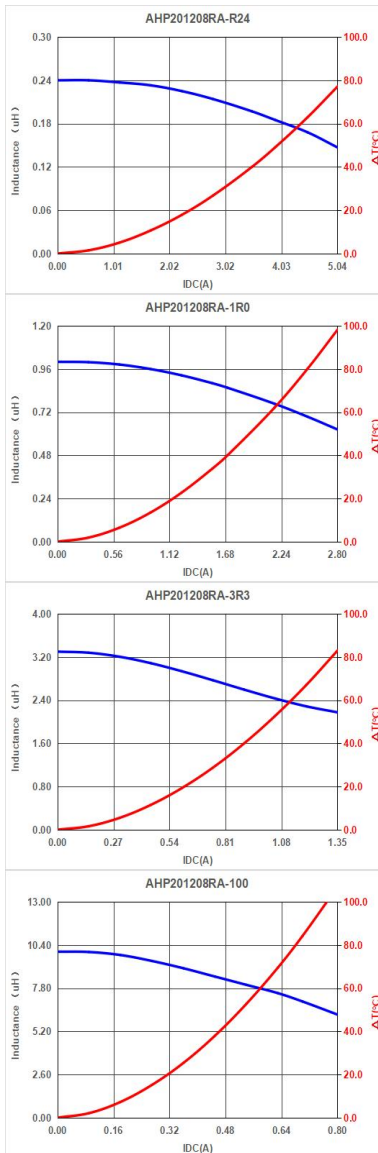

AHP201210RA

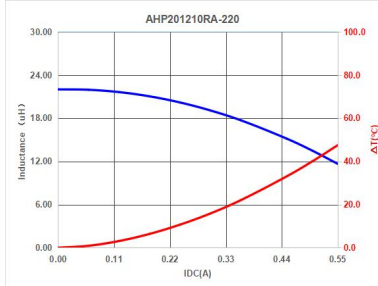
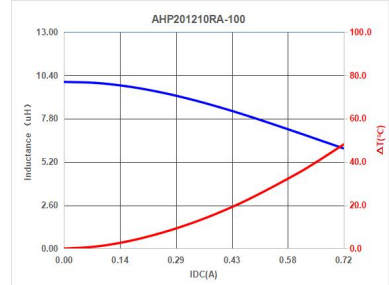
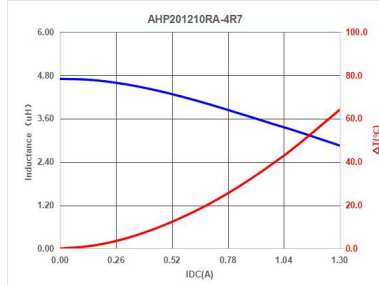
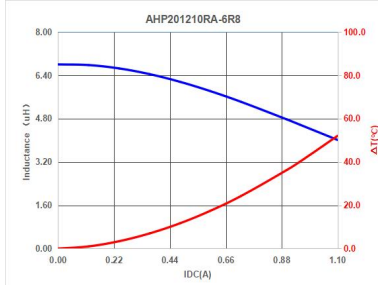
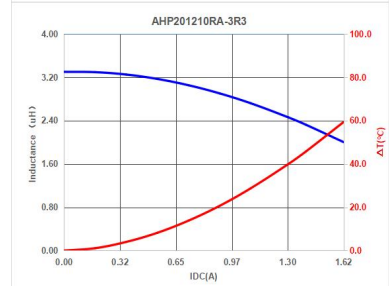
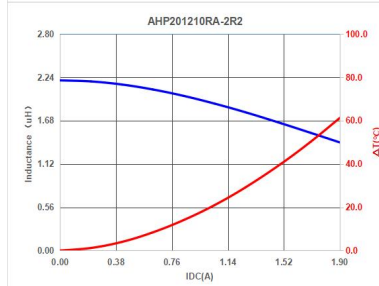
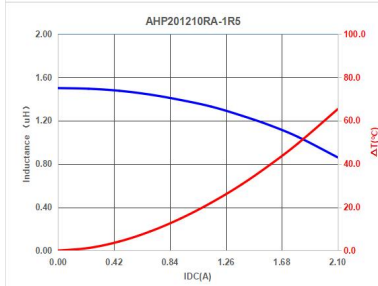
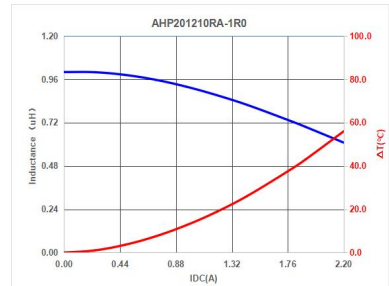
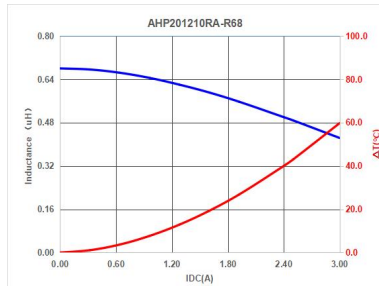
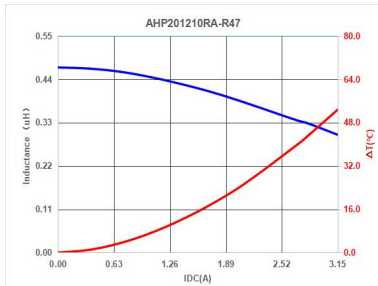

AHP201608RA

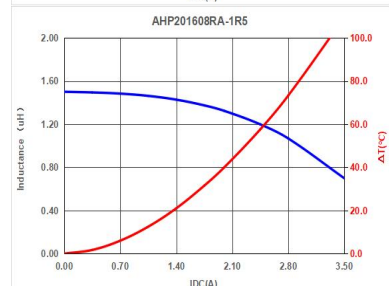
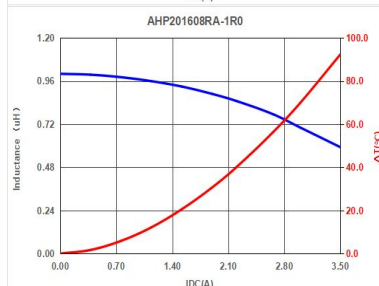
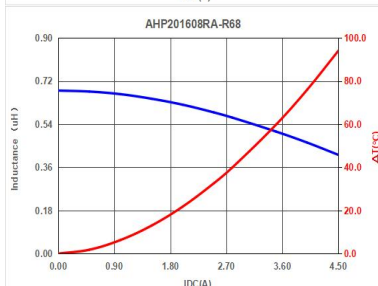
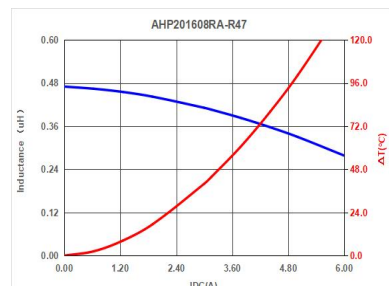
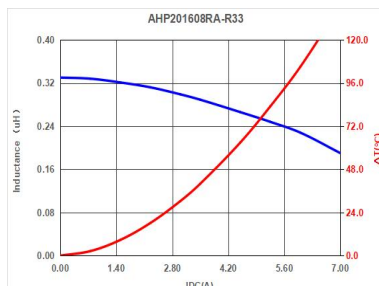
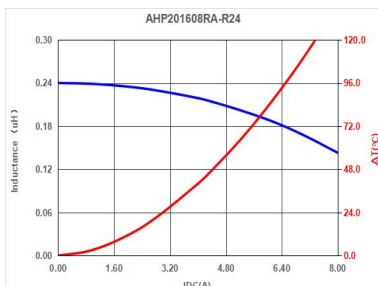

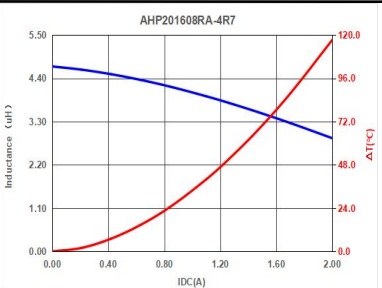
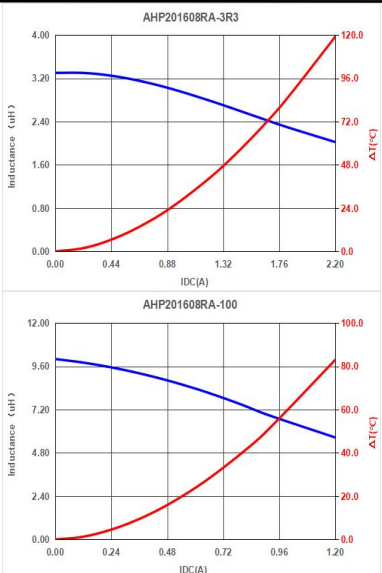
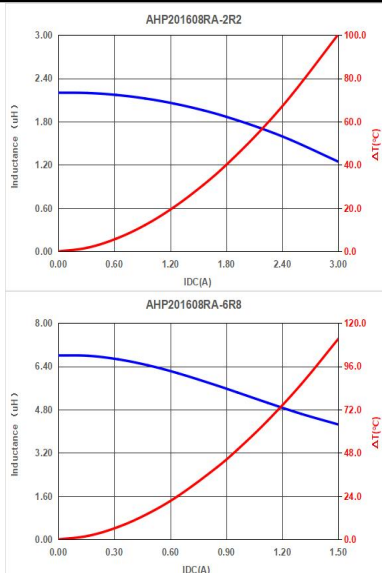

AHP201610RA

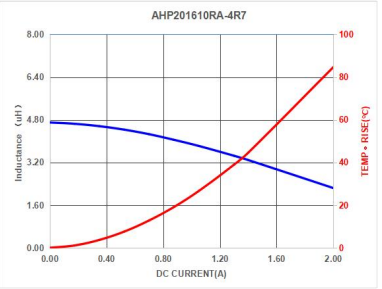
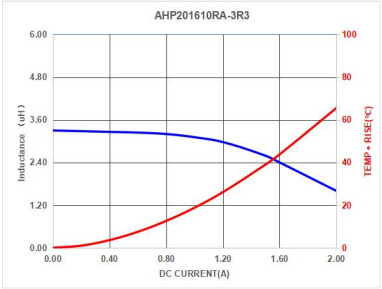
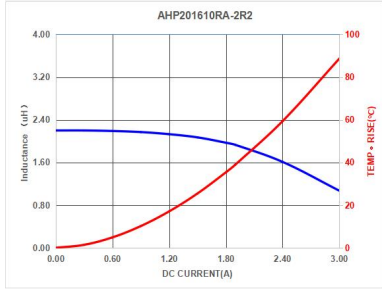
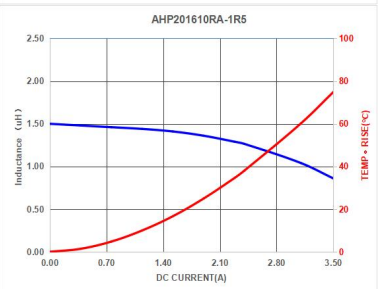
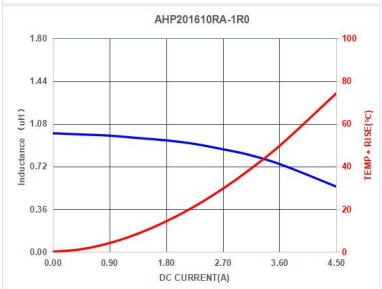
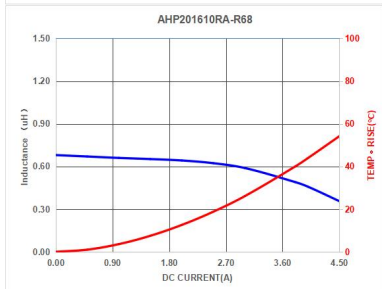
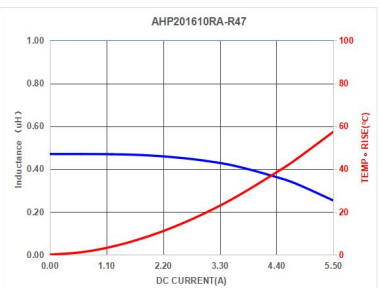
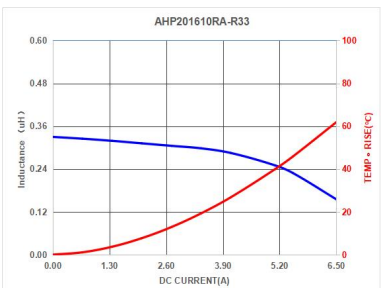
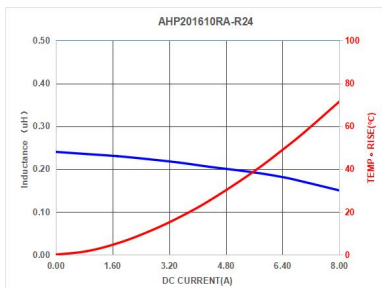

AHP252008RA

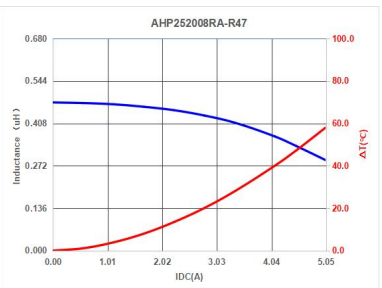
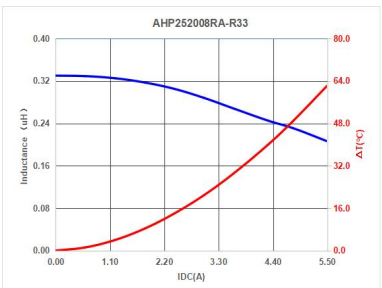
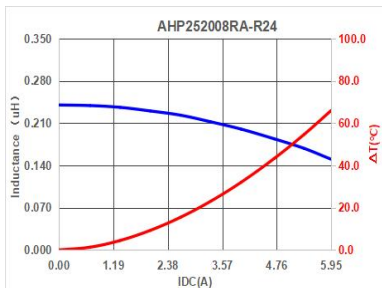

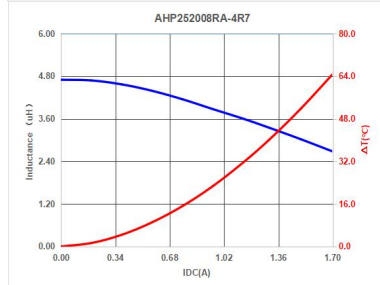
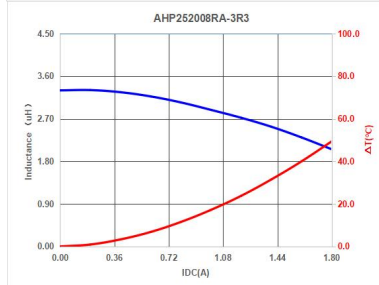
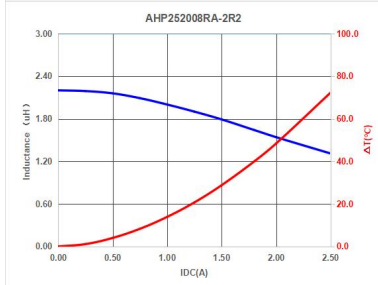
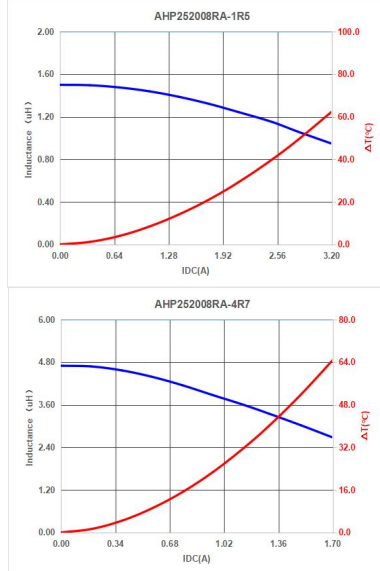
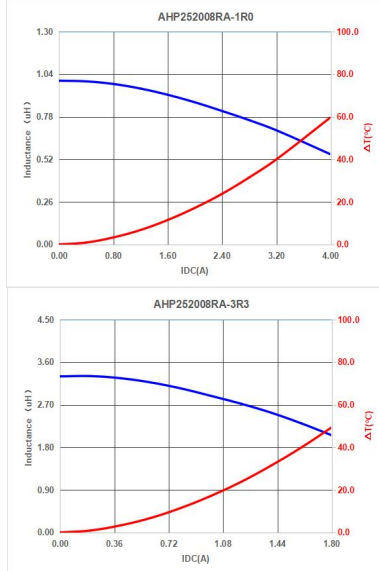
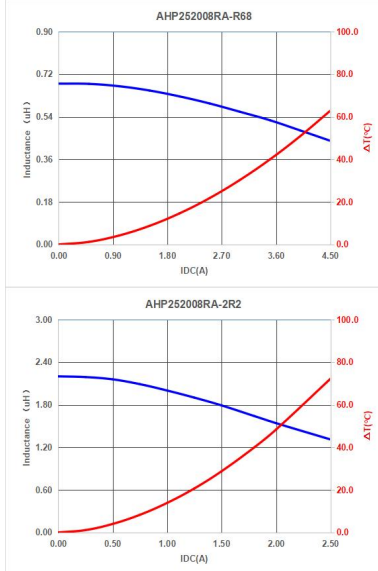

AHP3008RA

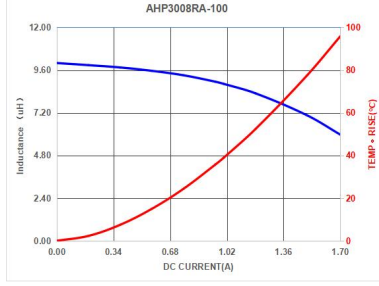
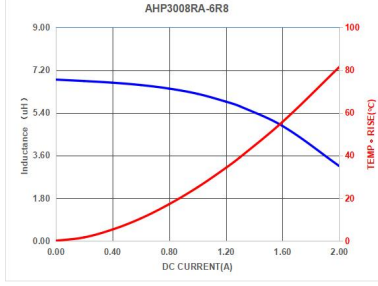
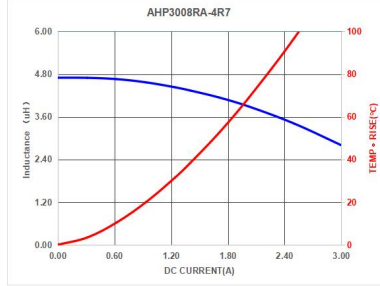
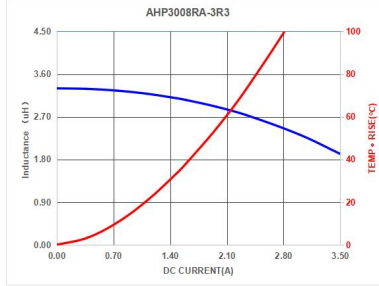
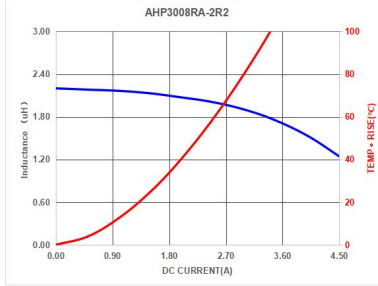
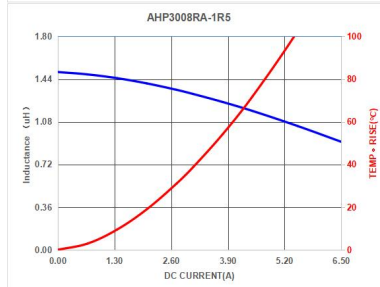
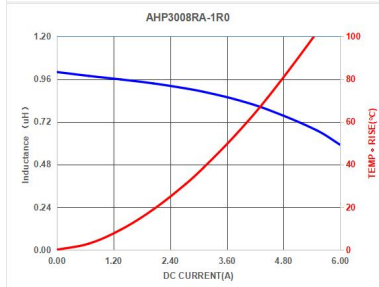
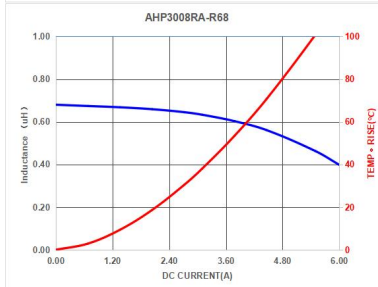
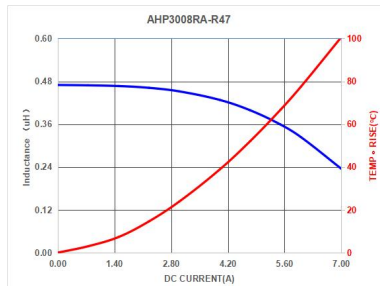
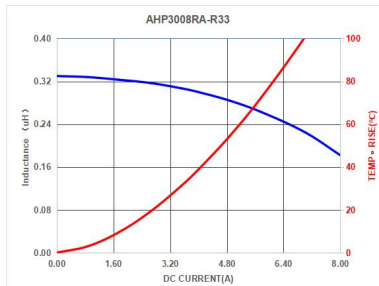
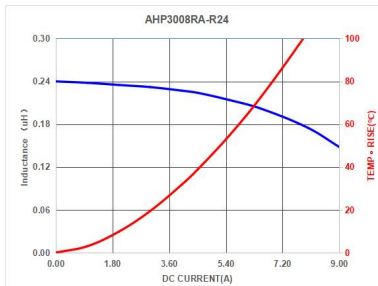

AHP322508RA

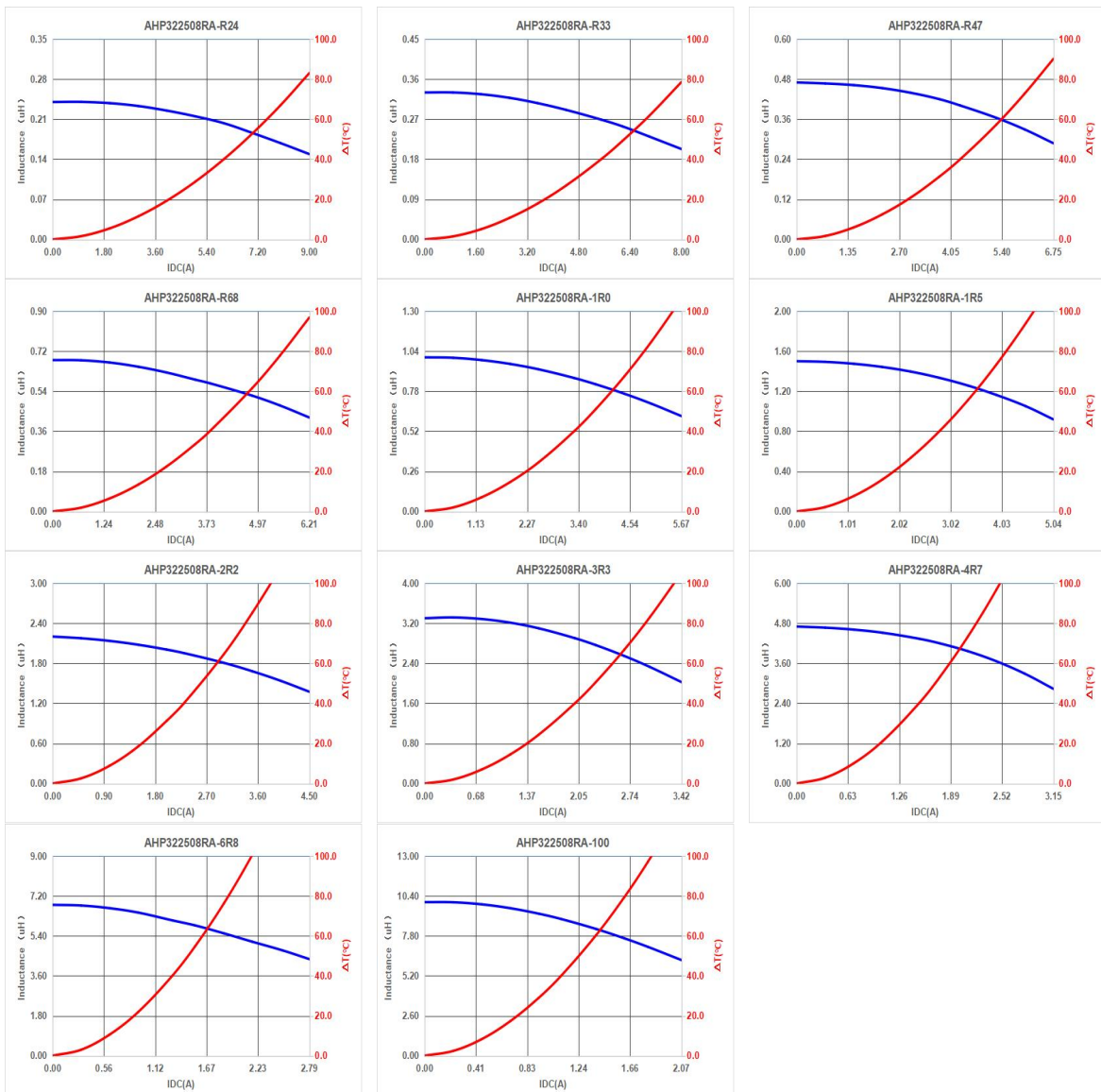

AHP322512RA

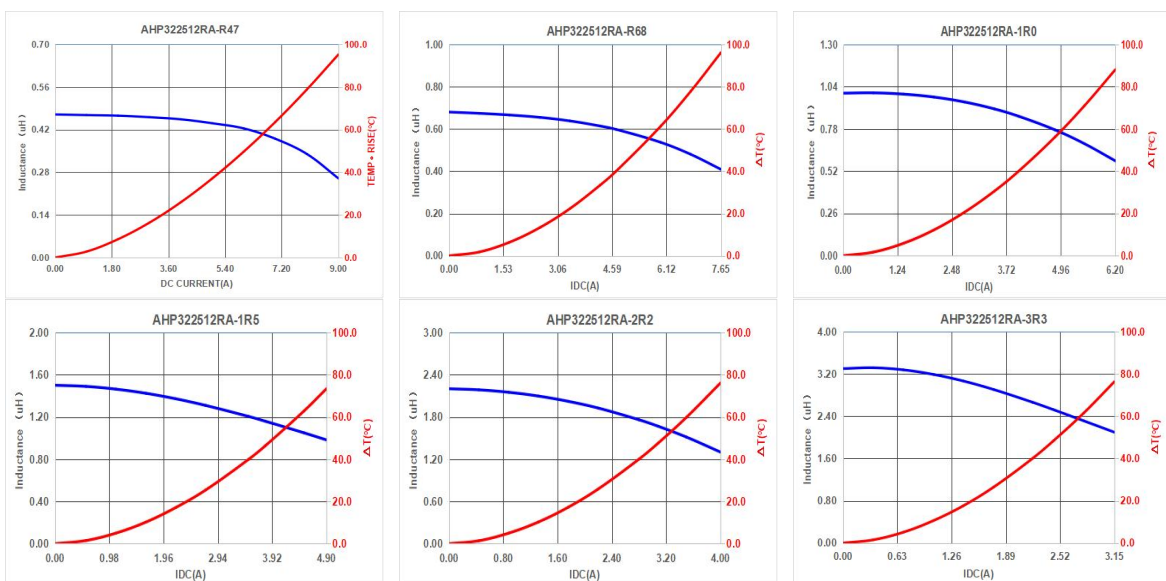

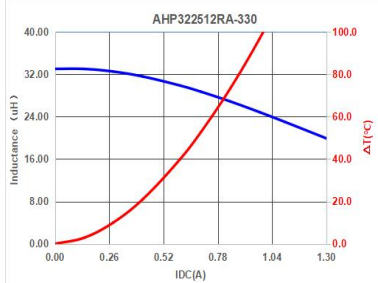
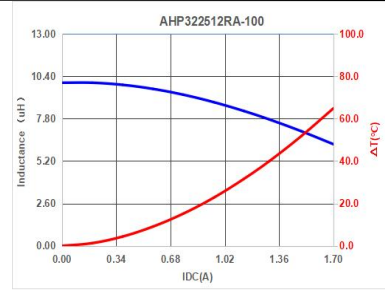
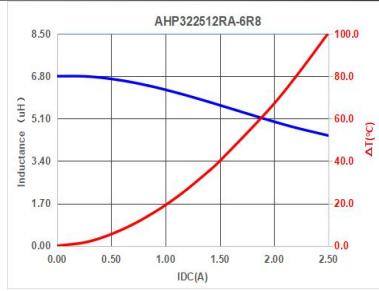
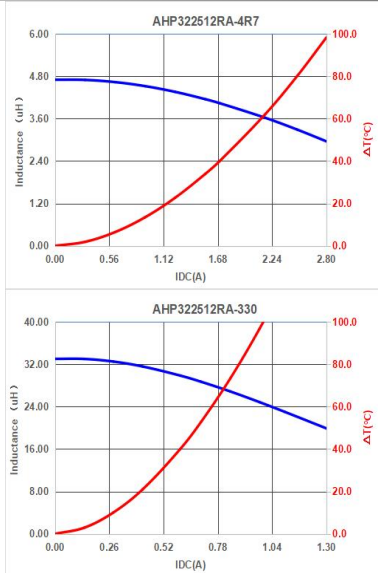

AHP4008RA

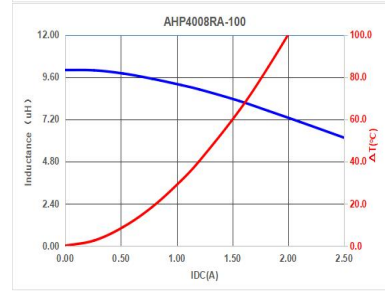
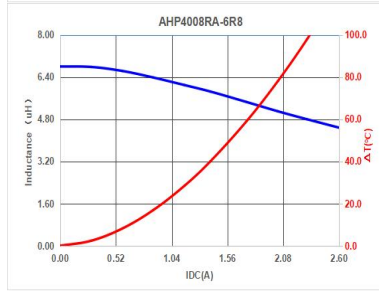
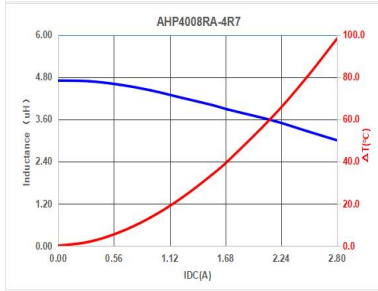
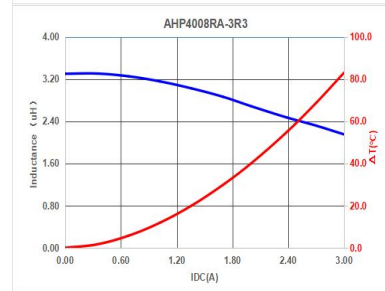
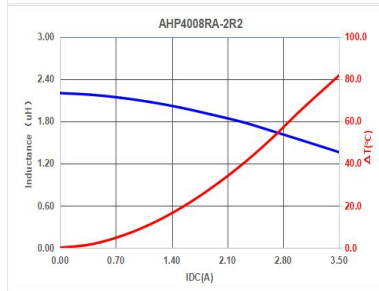
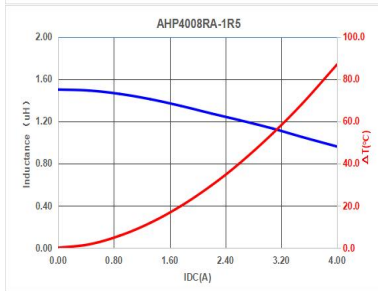
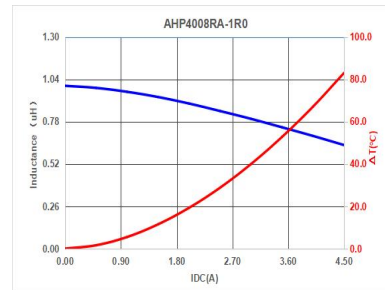
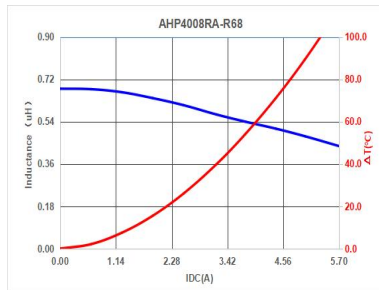
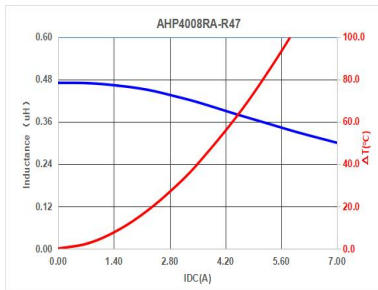

AHP201610HF

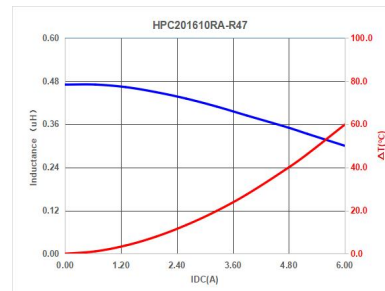
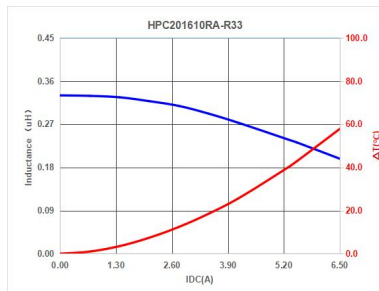
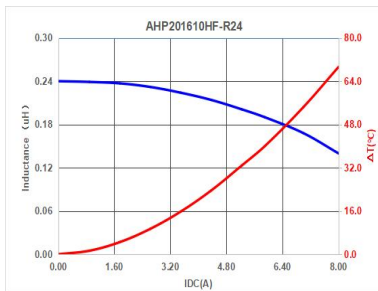

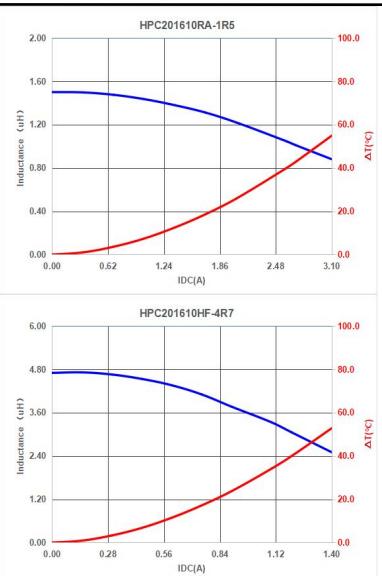
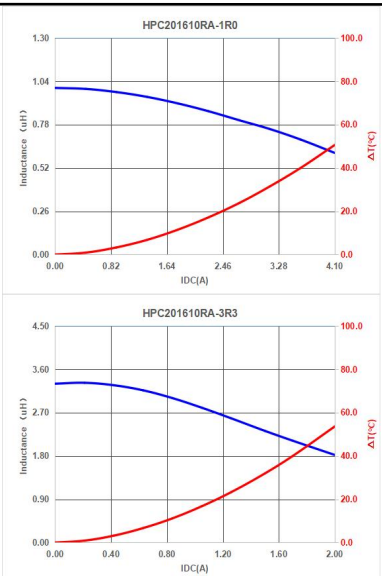
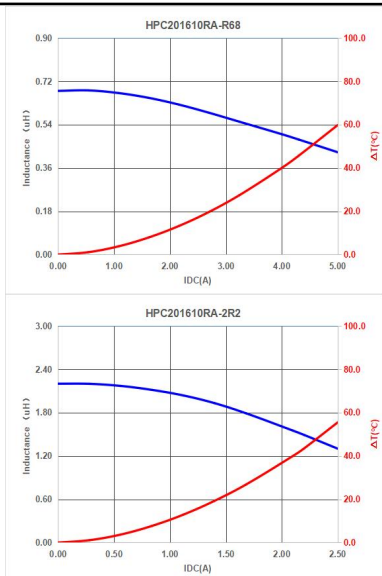

AHP252010HF

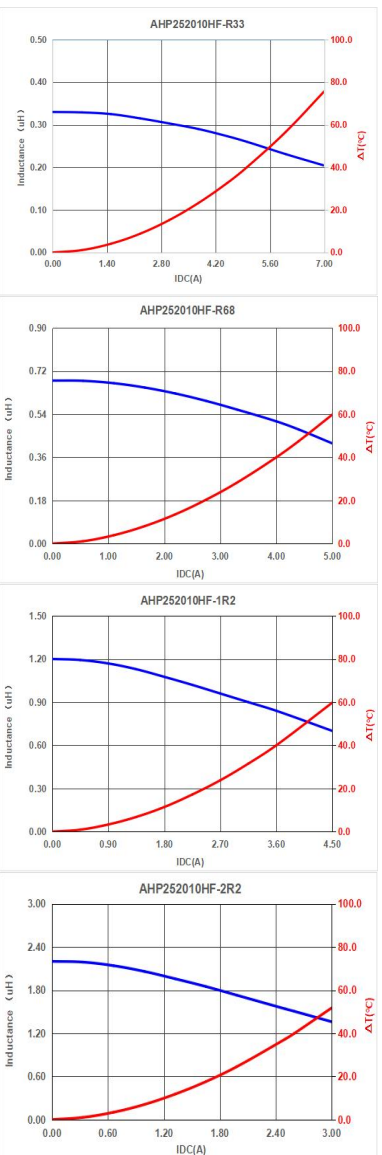
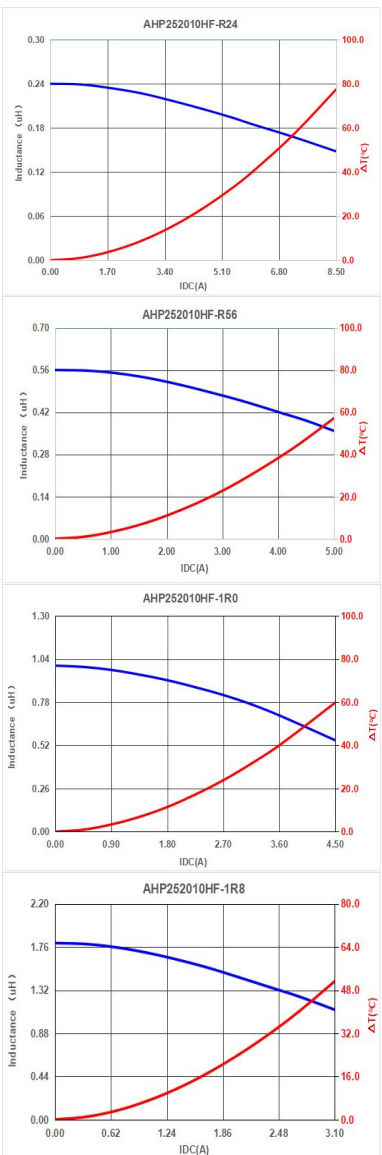
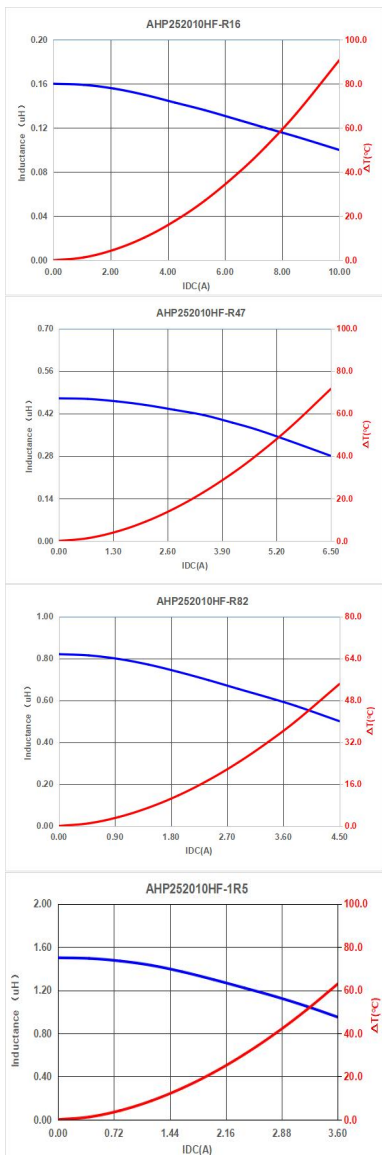

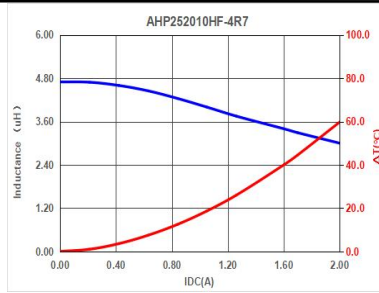
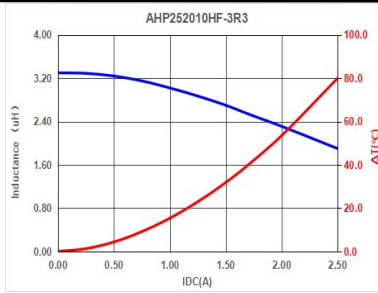

AHP252012HF

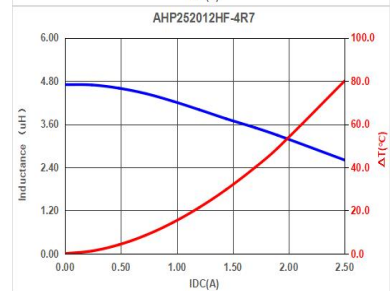
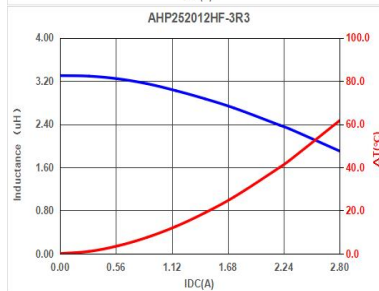
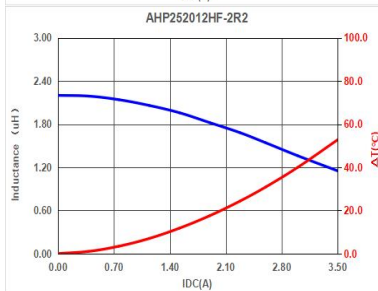
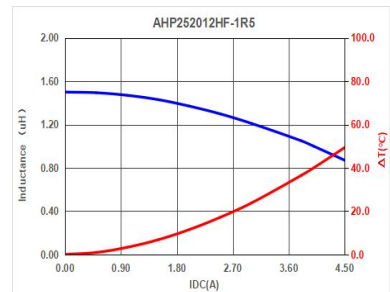
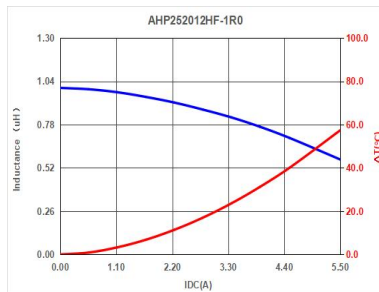
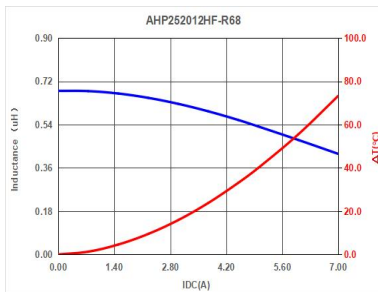
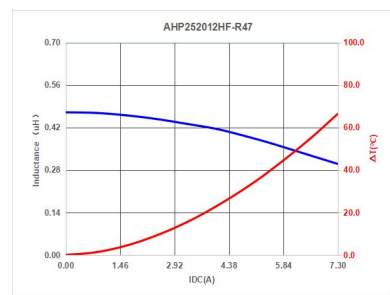
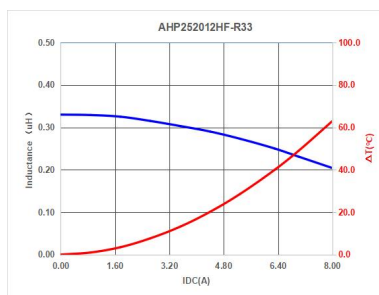
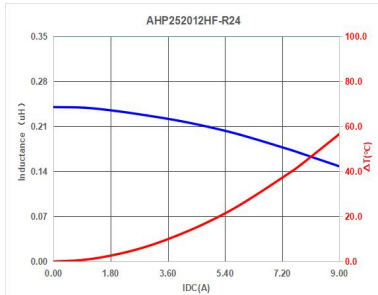

AHP3010HF

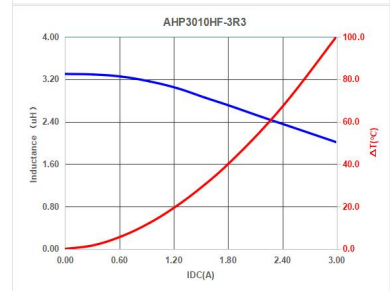
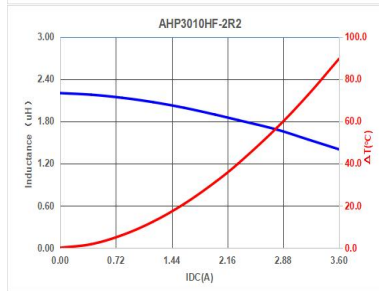
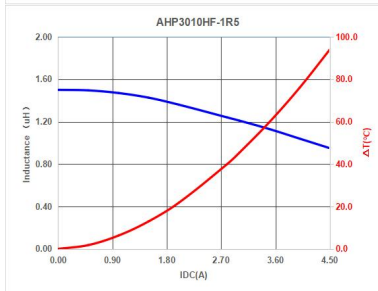
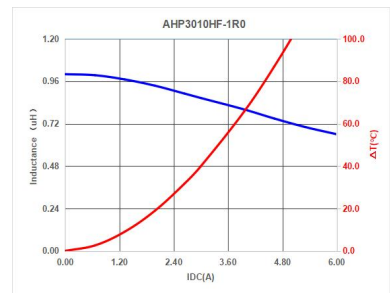
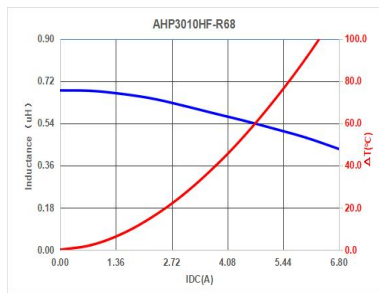
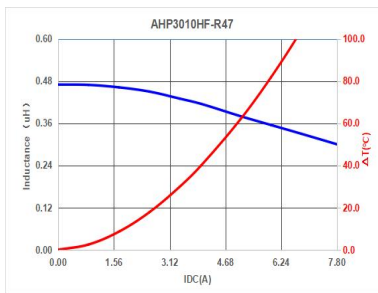

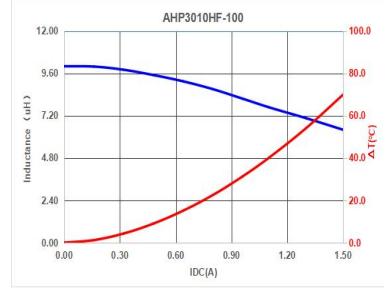
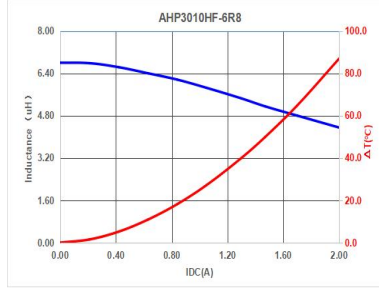
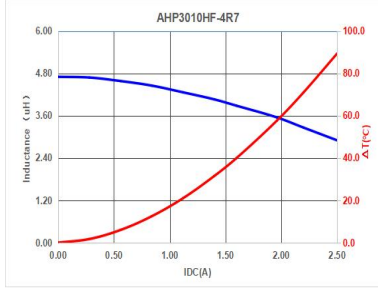

AHP3012HF

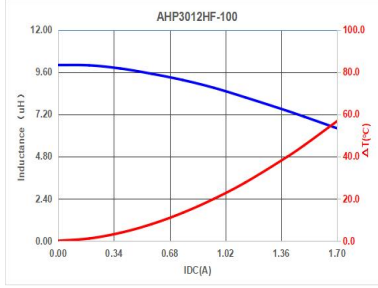
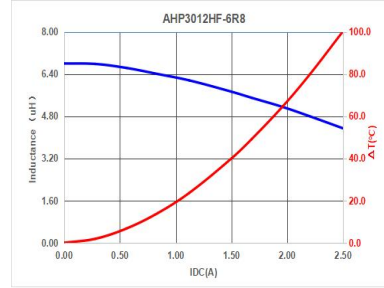
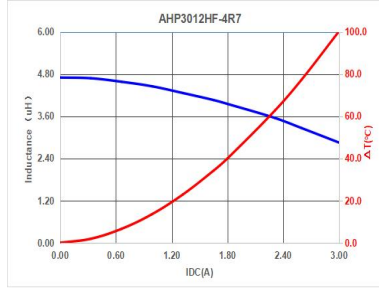
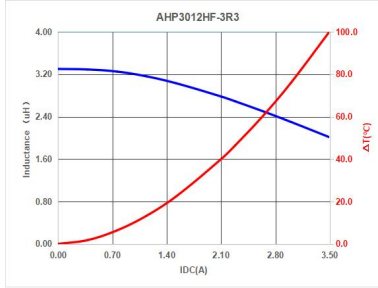
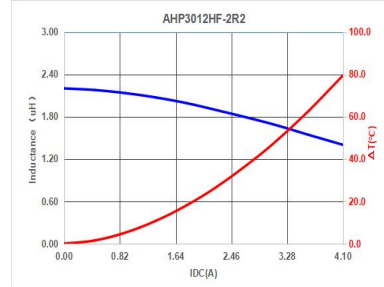
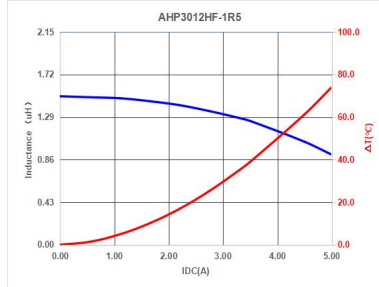
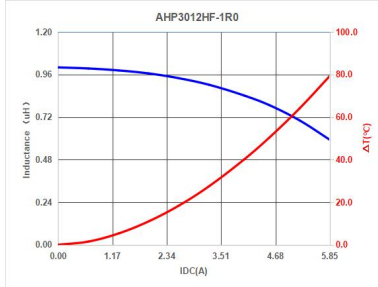
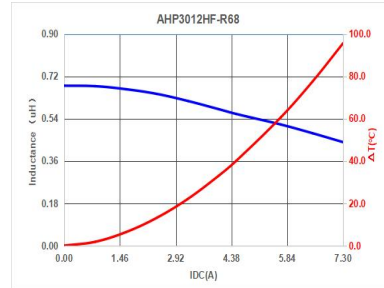
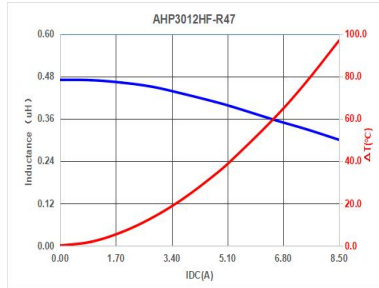
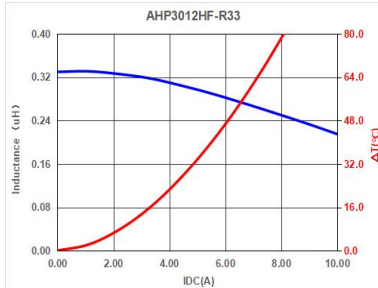

AHP4010HF

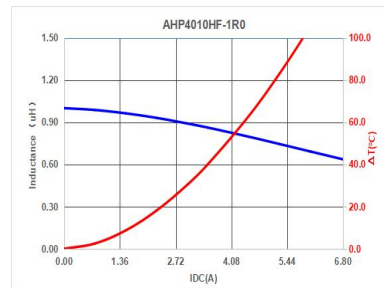
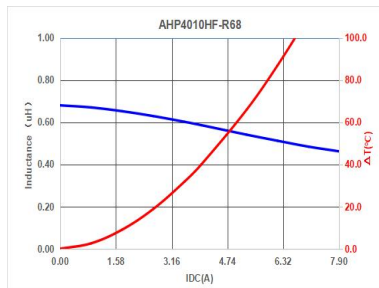
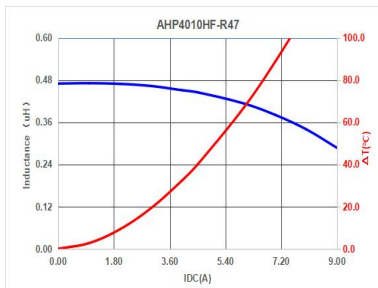

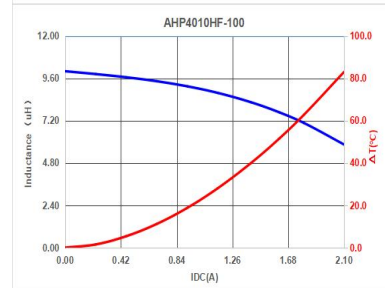
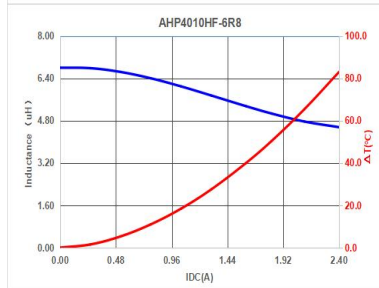
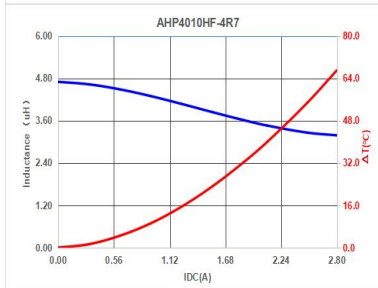
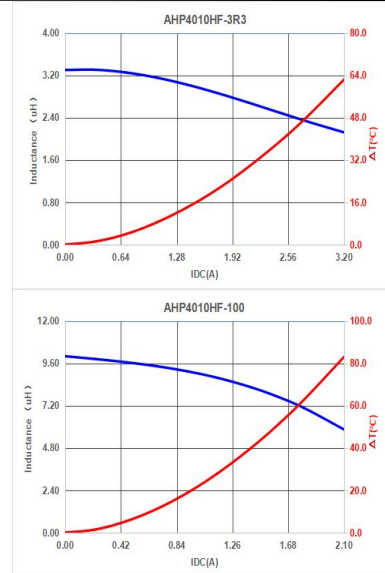
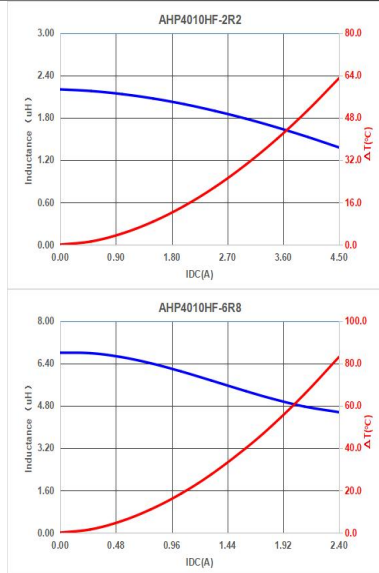
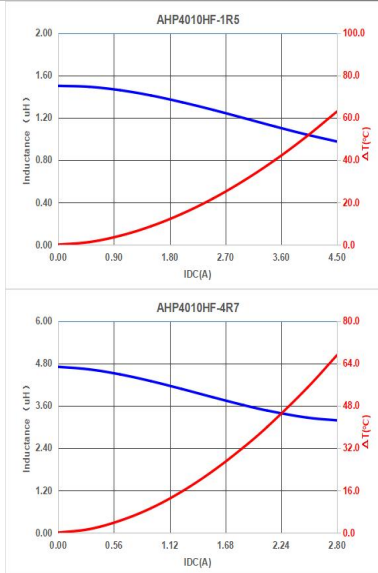

AHP4012HF

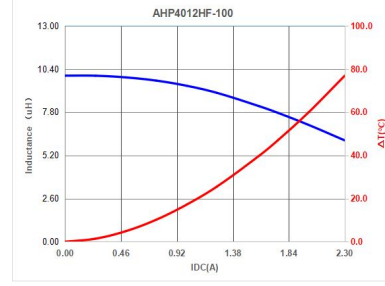
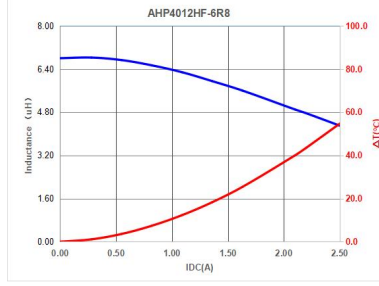
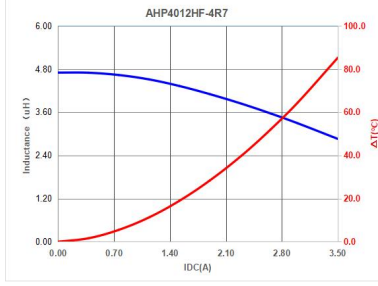
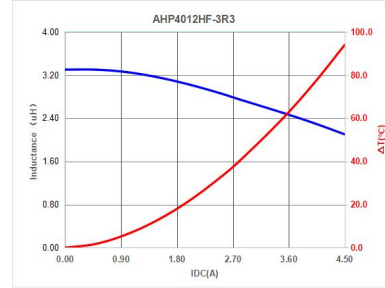
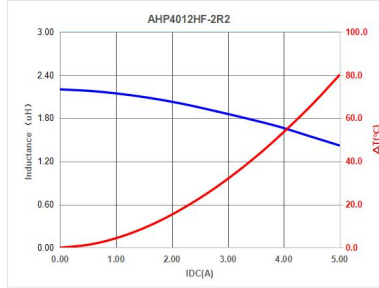
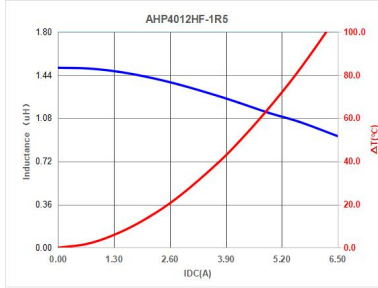
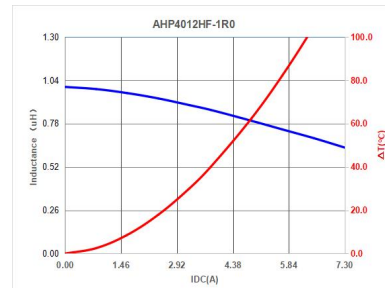
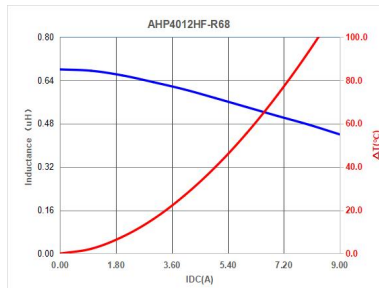
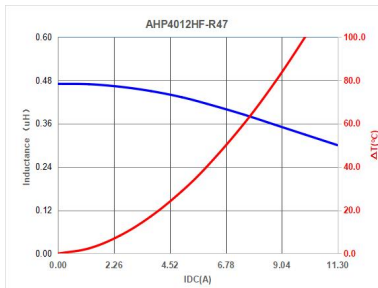

AHP160808FA

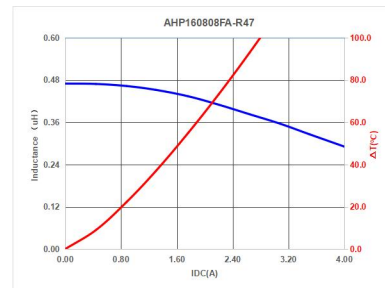
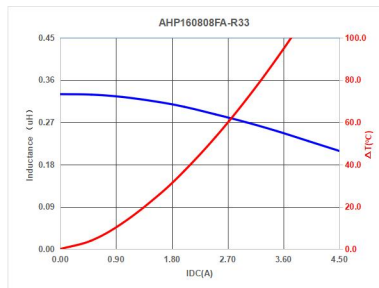
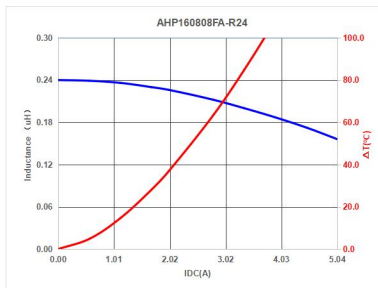

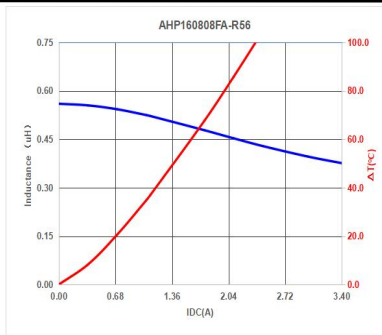

AHP121008FA

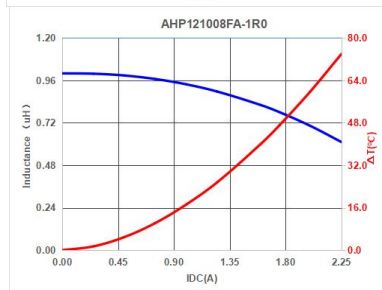
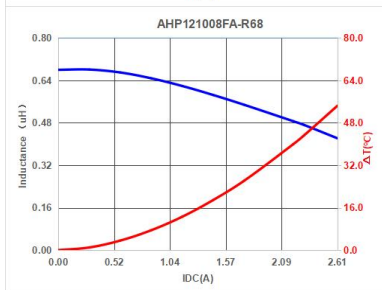
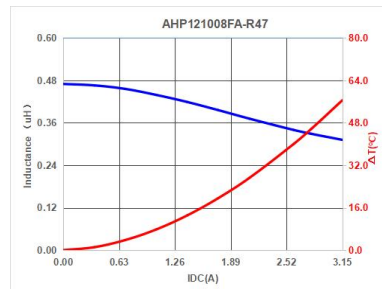
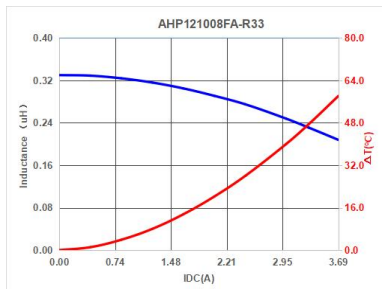
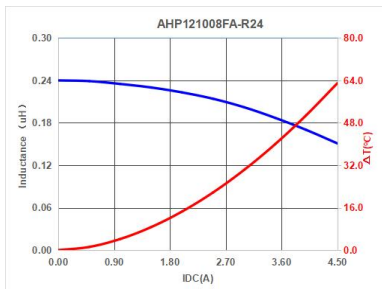

AHP201208FA

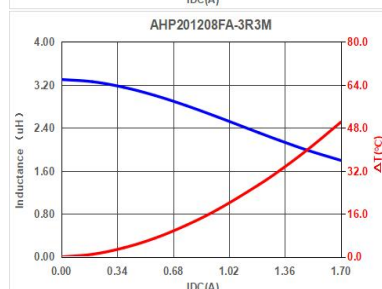
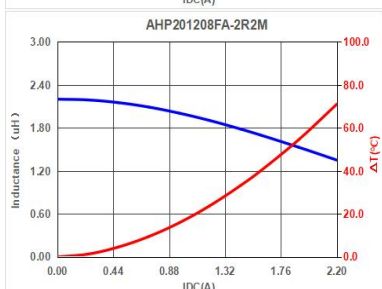
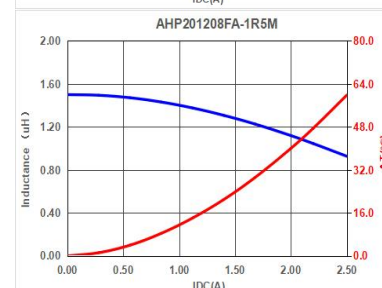
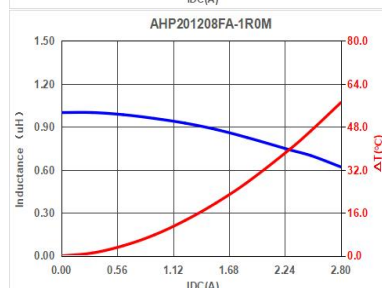
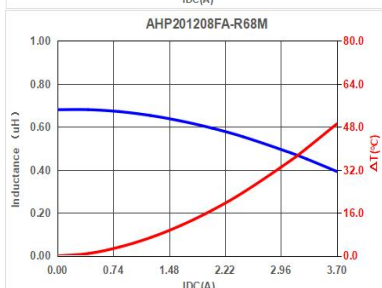
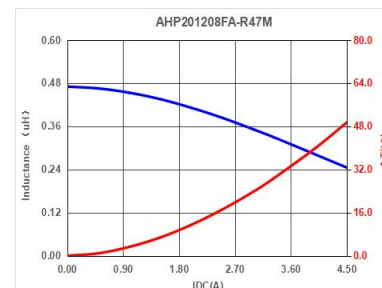
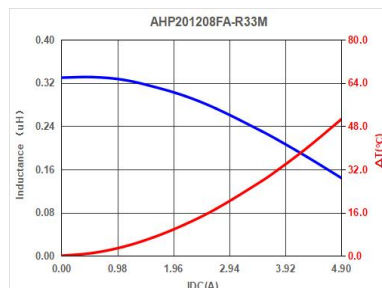
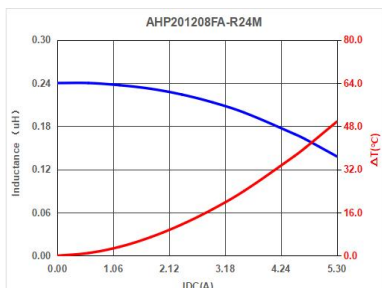

AHP201210FA

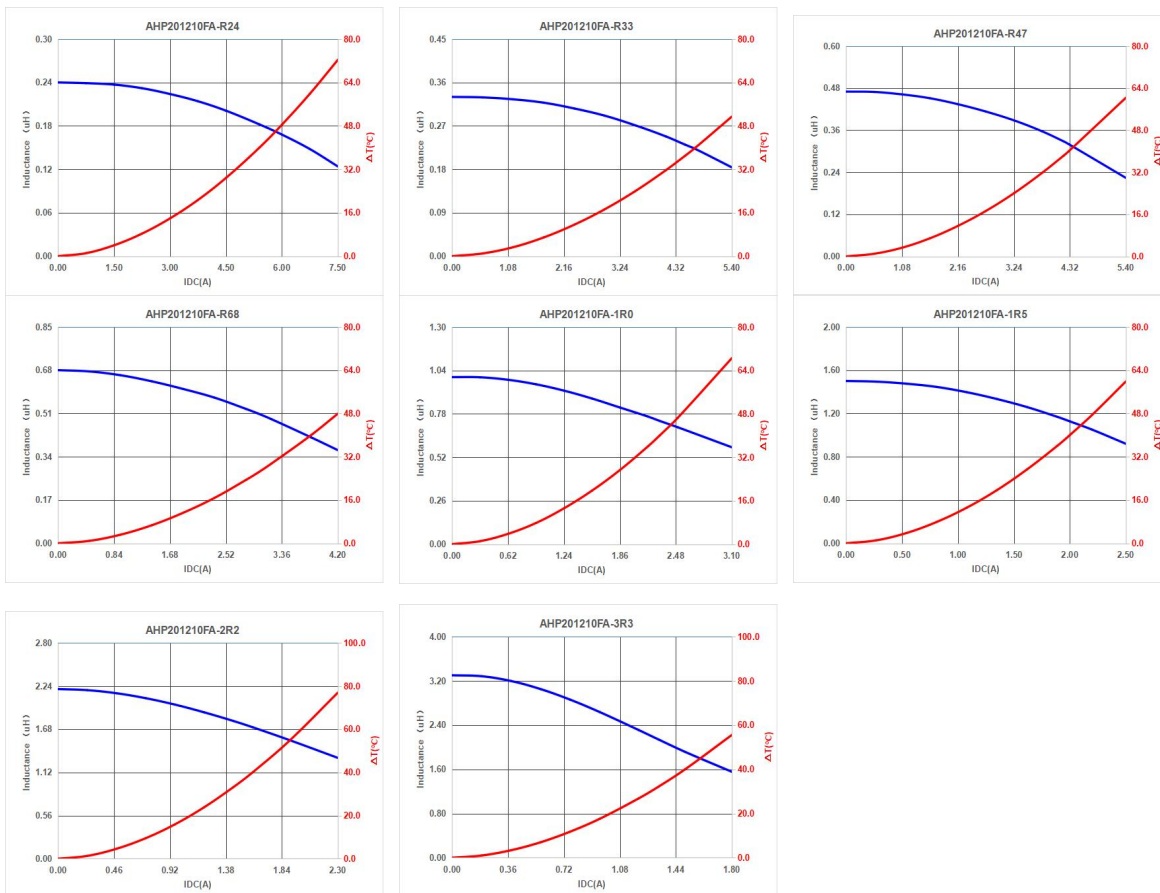

AHP201608FA

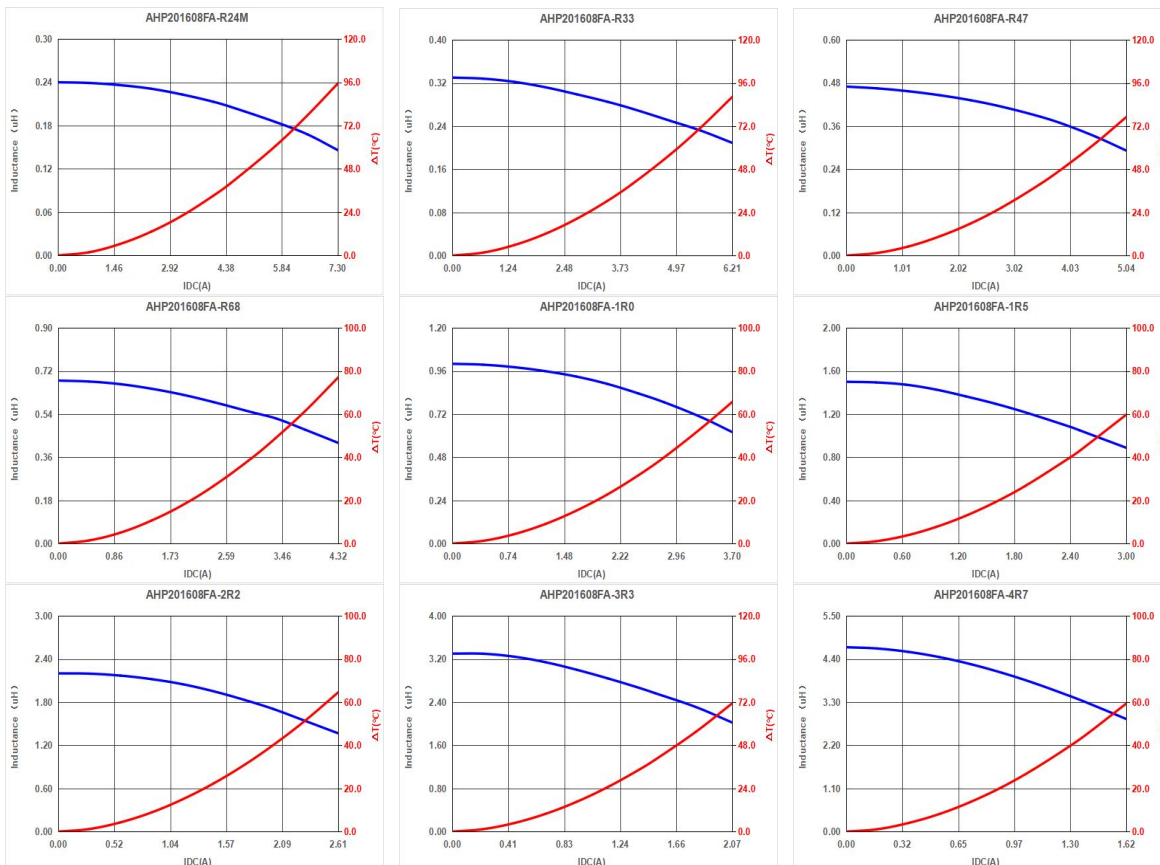

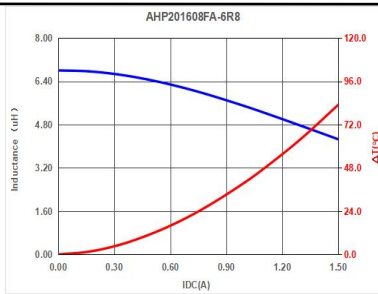

AHP201610FA

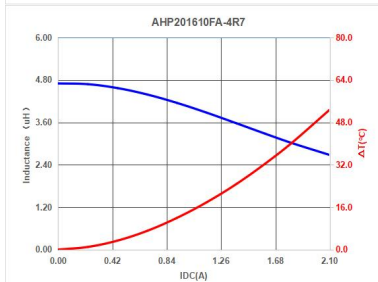
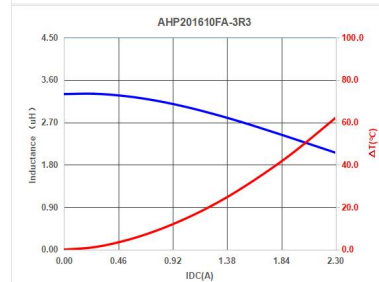
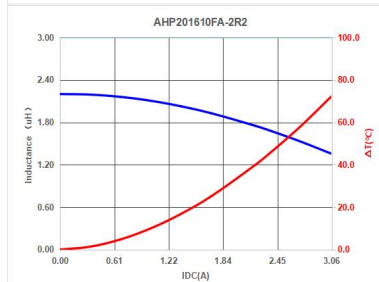
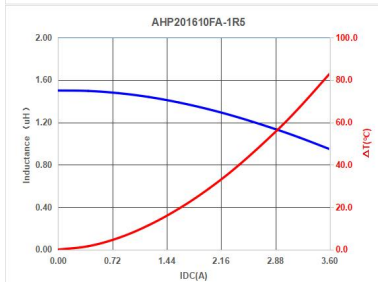
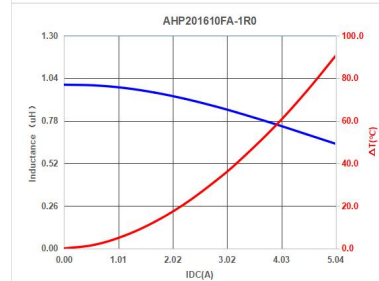
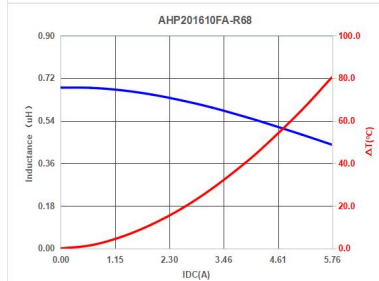
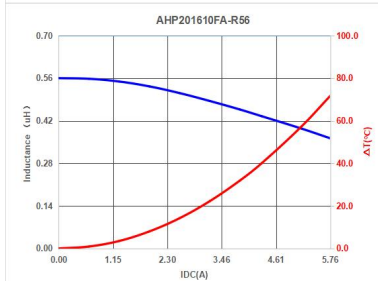
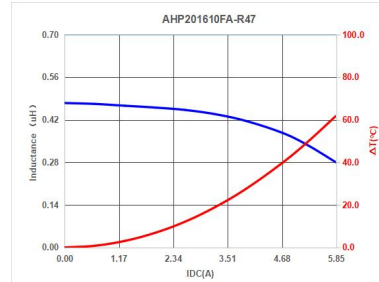
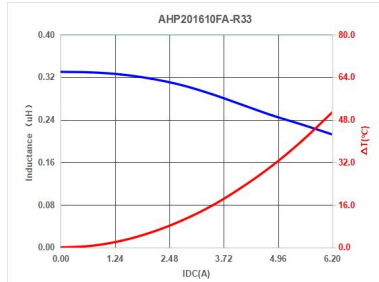
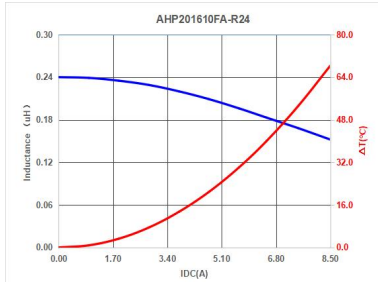

AHP252008FA

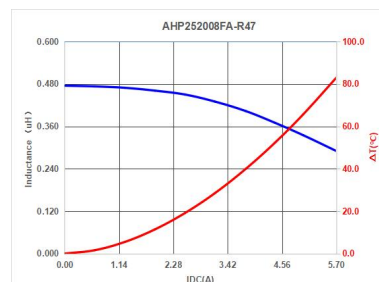
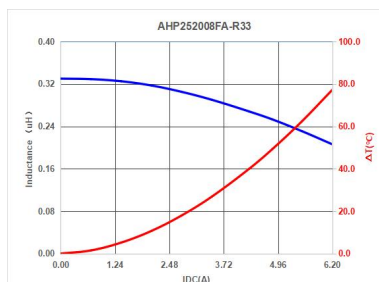
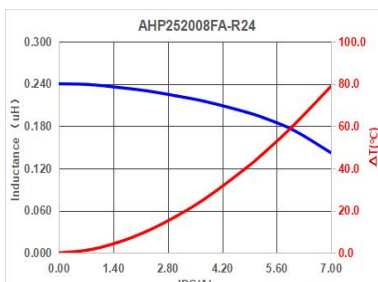

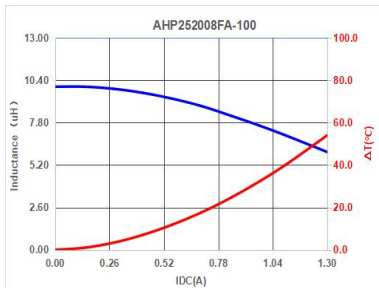
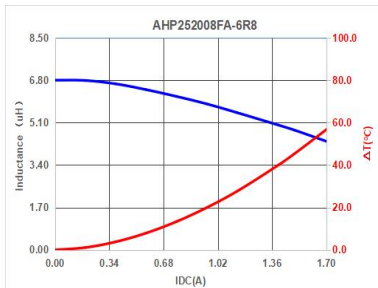
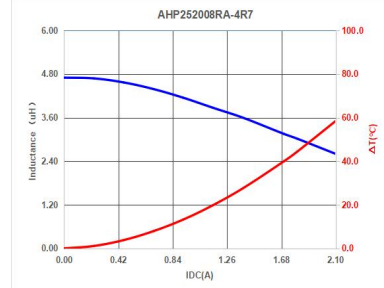
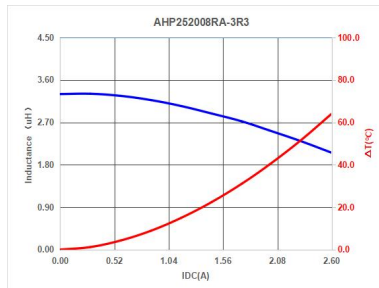
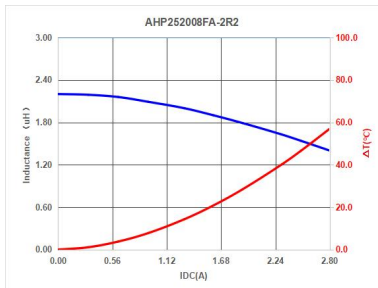
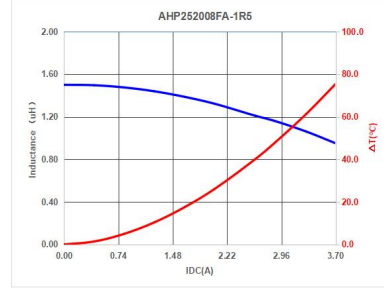
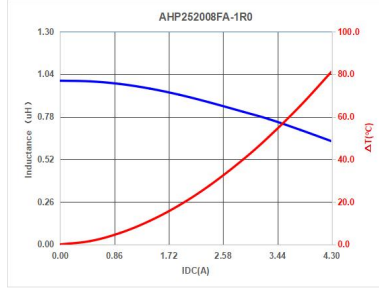
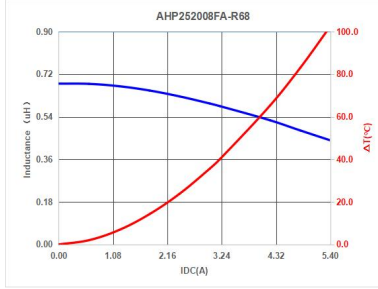

AHP252010FA

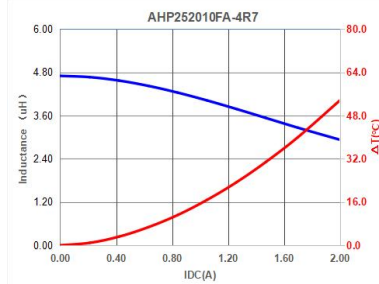
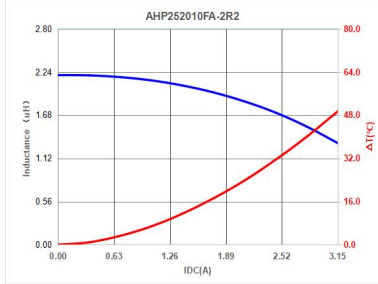
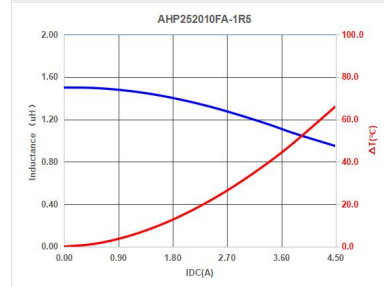
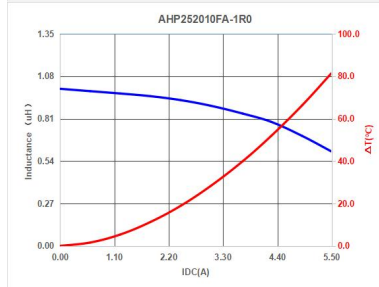
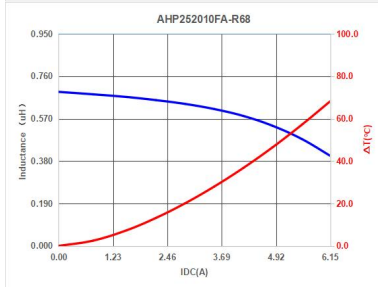
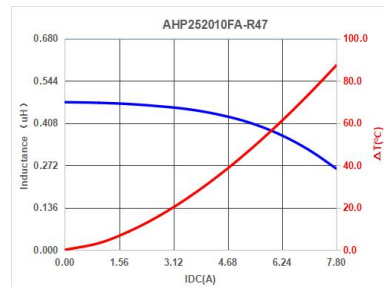
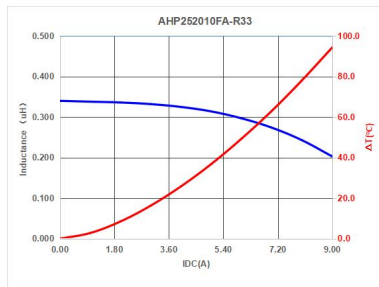
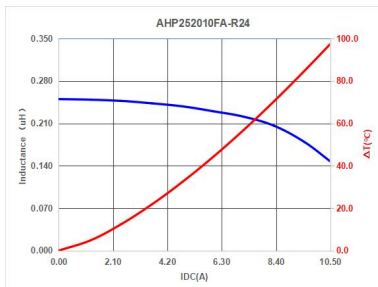

AHP252012FA

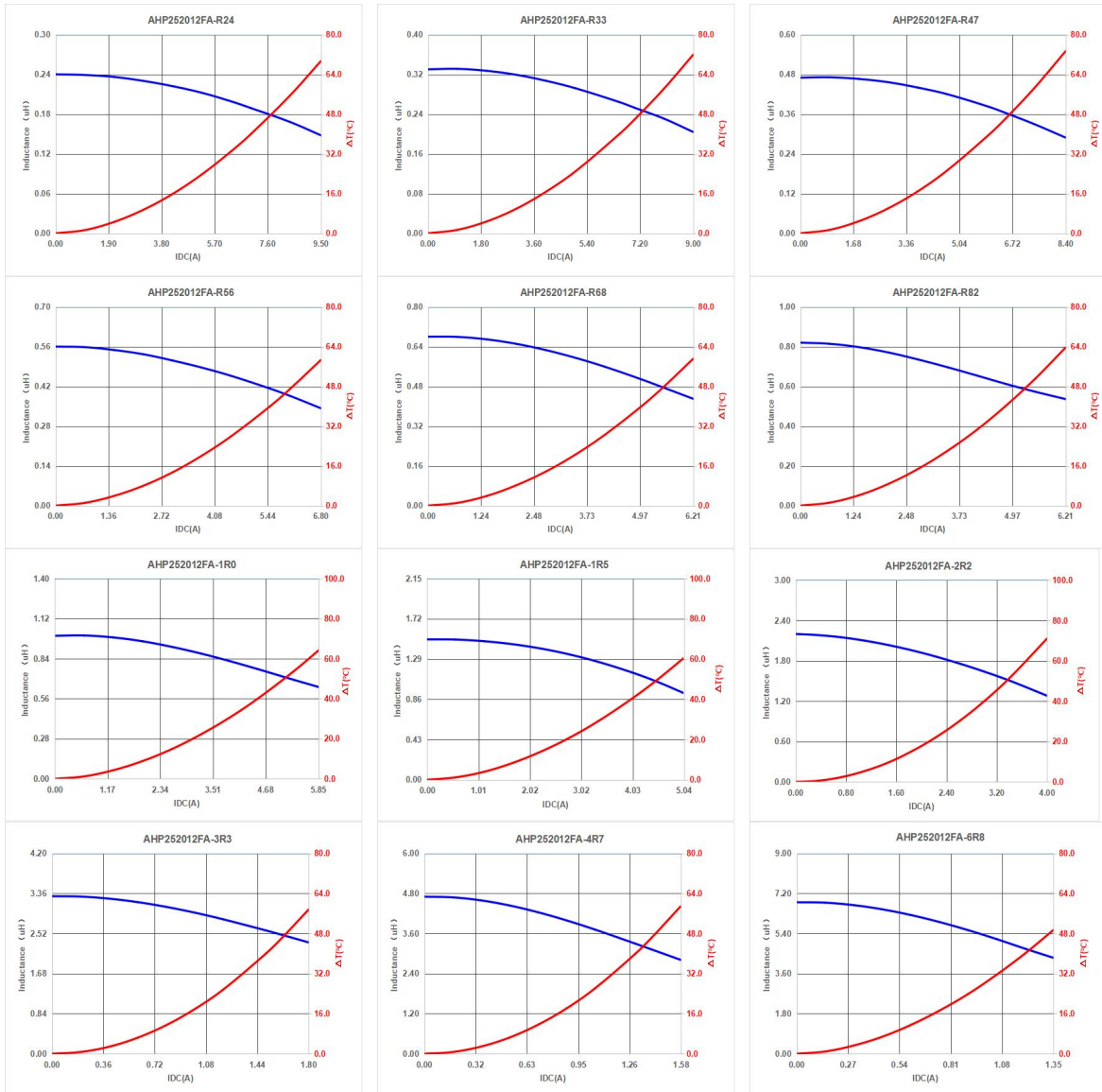

AHP322512FA

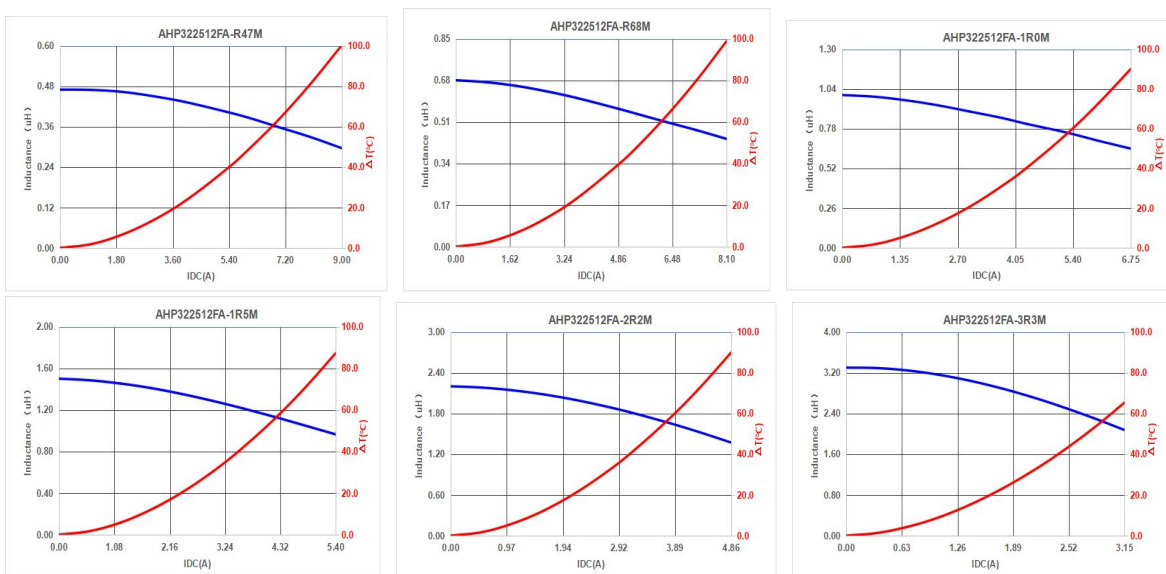

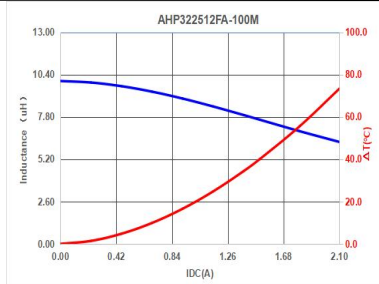
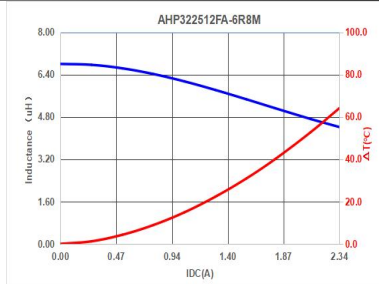
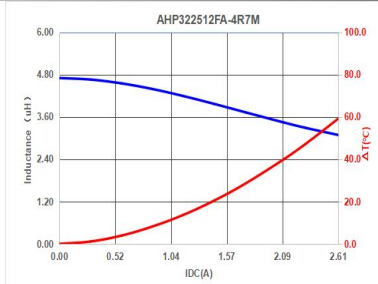

AHP252010RA

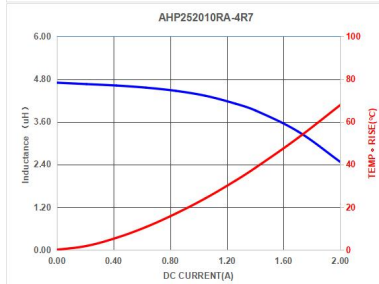
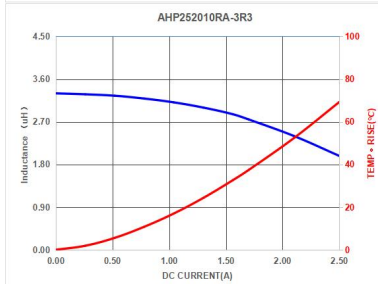
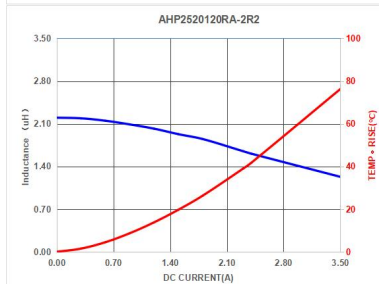
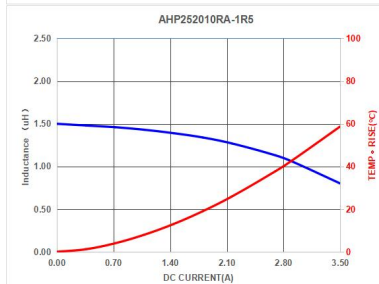
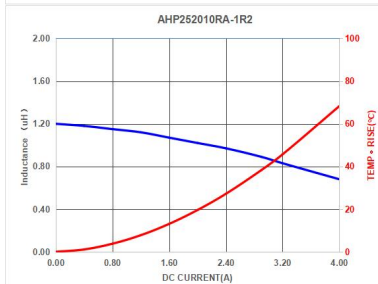
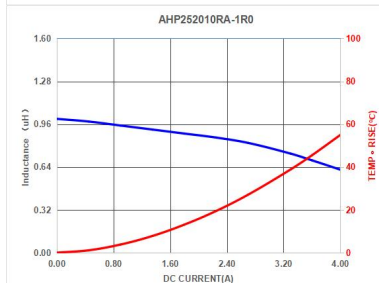
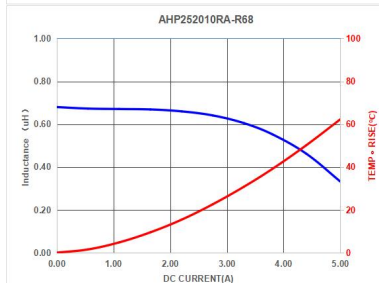
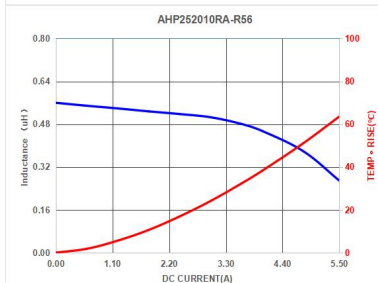
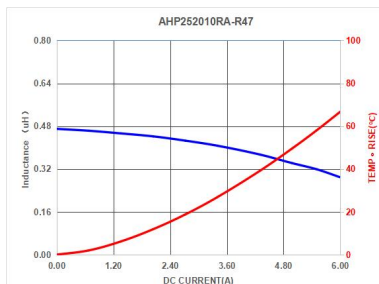
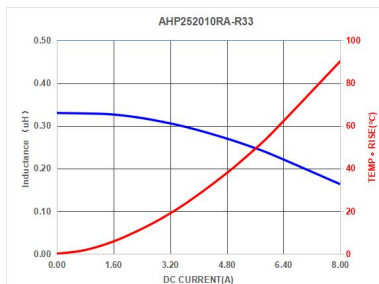
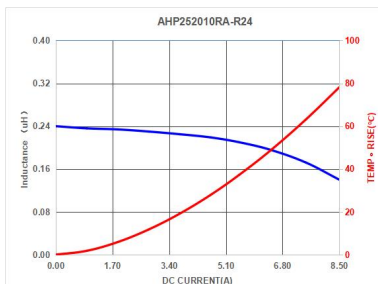

AHP3008RA

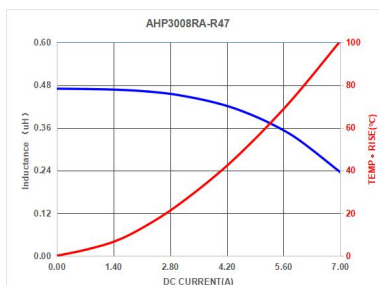
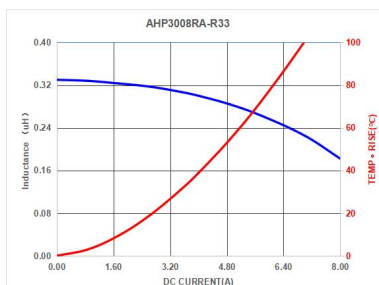
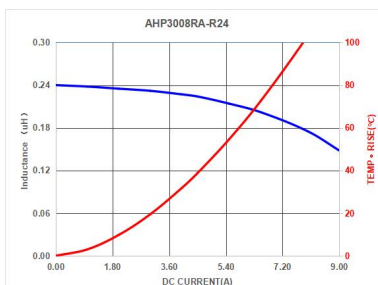

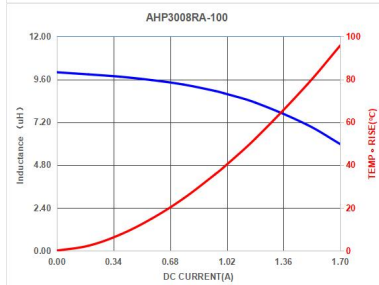
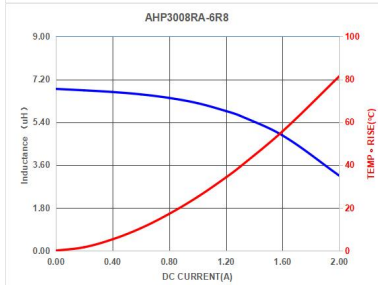
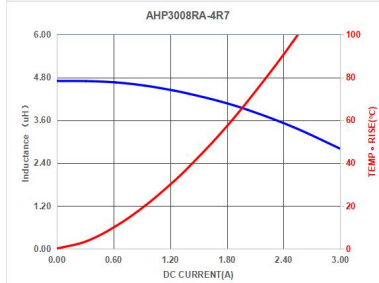
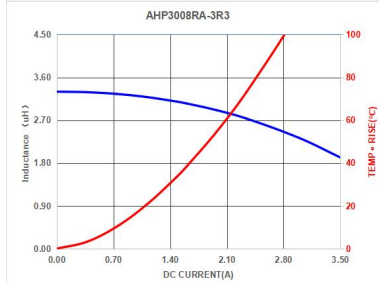
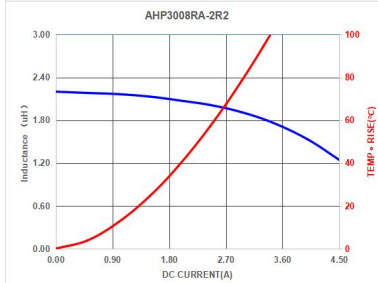
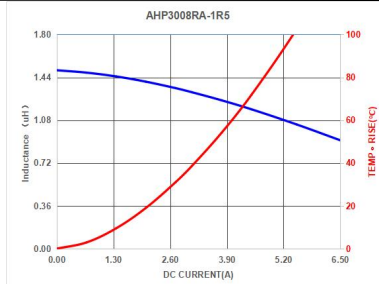
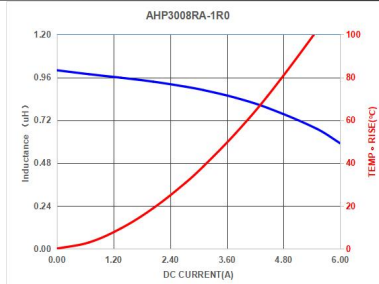
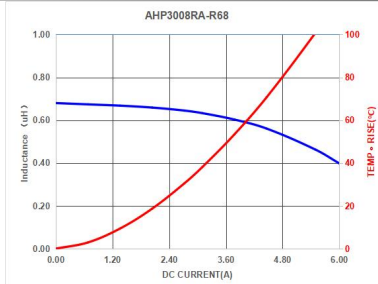

AHP3015RA

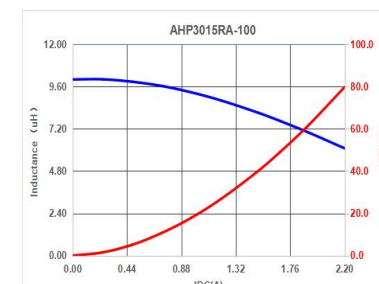
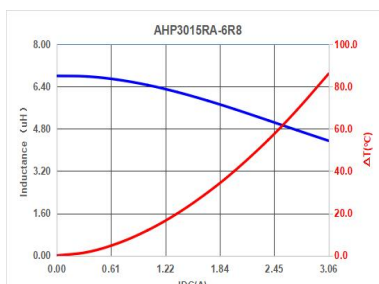
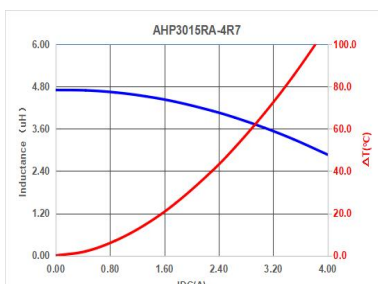
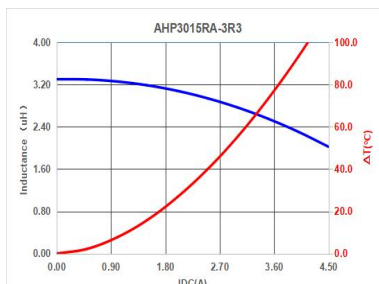
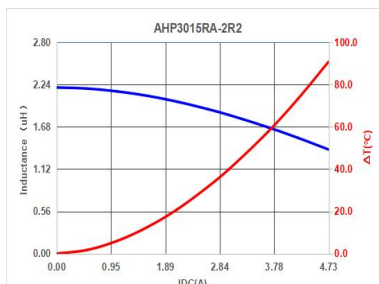
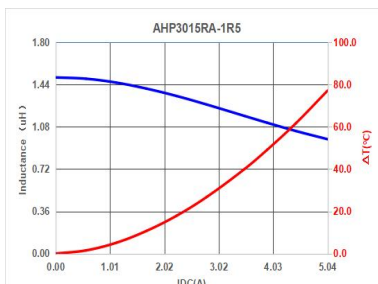
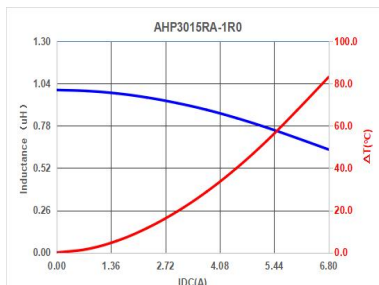
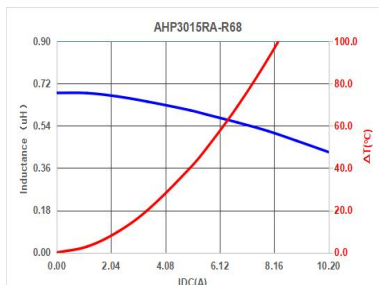
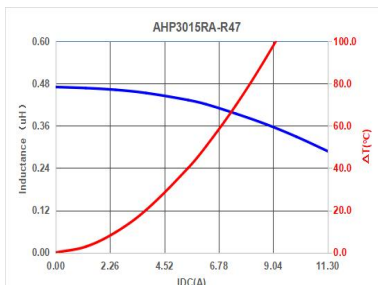

AHP252012RA

