

極数 POS.	品番 No.	A	B	C
2	13103S-02*-NP	11.4	6	2
4	13103S-04*-NP	15.4	10	6
8	13103S-08*-NP	23.4	18	14
10	13103S-10*-NP	27.4	22	18
12	13103S-12*-NP	31.4	26	22
16	13103S-16*-NP	39.4	34	30
20	13103S-20*-NP	47.4	42	38

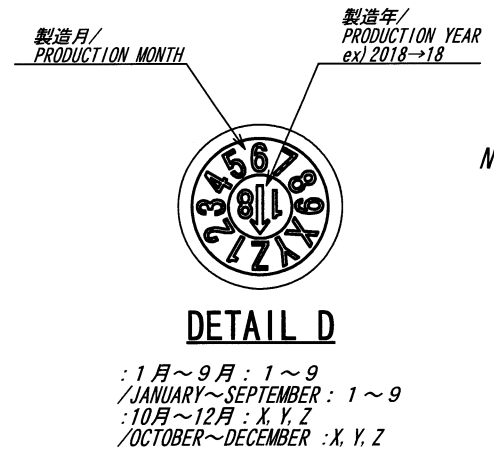
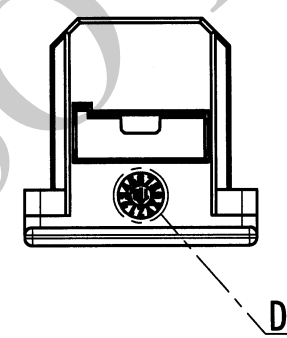
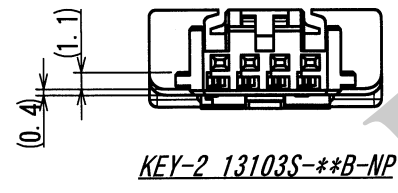
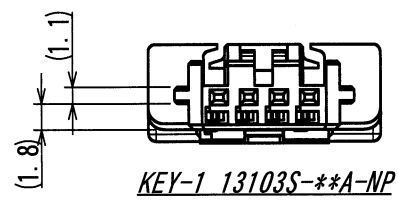
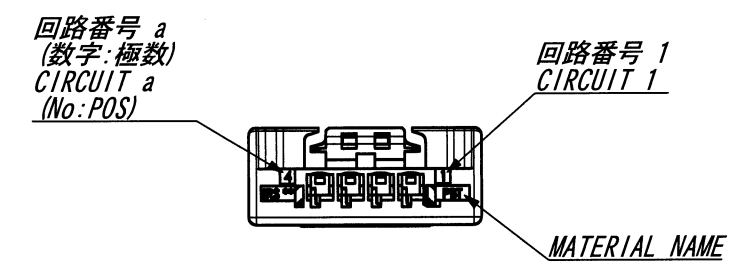
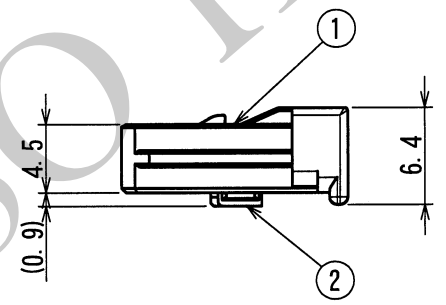
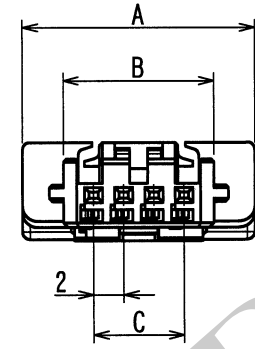
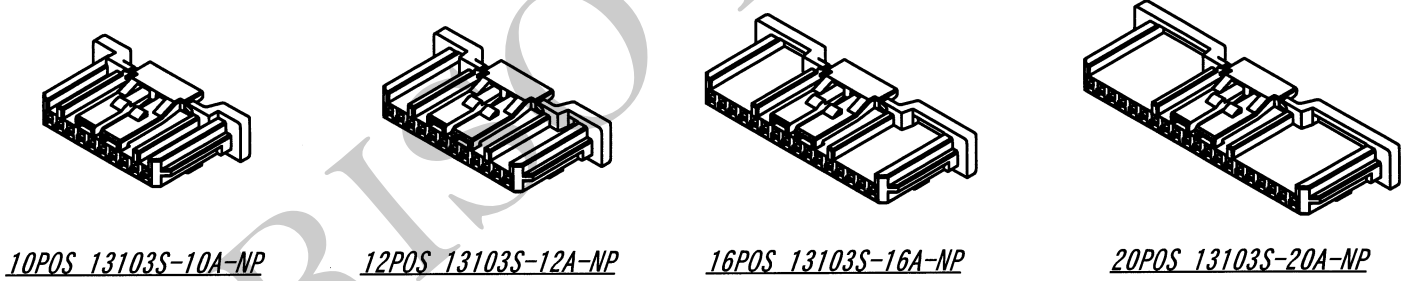
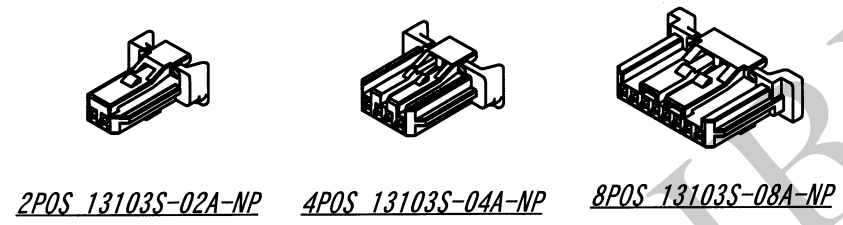
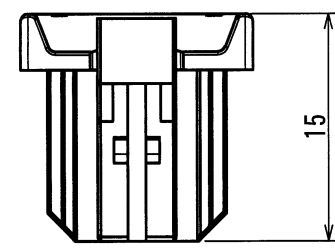

NOTE:

1. 仮係止時リテーナ突起がハウジングの外側に出ていること。  
(リテーナが仮係止状態。)  
納品時、本係止状態になっている場合は、仮係止状態にして下さい。

1. THE RETENTION LATCH OF THE RETAINER MUST BE OUT SIDE OF SOCKET HOUSING WHEN PRE-ASSEMBLY. (RETAINER IS IN PRE-ASSEMBLED CONDITION) WHEN THE RETAINER IS IN FINAL LOCK CONDITION AT THE SHIPPED TO CUSTOMER, IT MUST BE UNLOCKED TO PRE-ASSEMBLED CONDITION.

MATERIAL 材質						GENERAL TOLERANCES 一般公差		SCALE 尺度		UNIT 単位		TITLE 名称	
①SOCKET HOUSING : PBT樹脂,UL94 V0、黒色/ PBT ,UL94 V0,COLOR:BLACK						DIM 寸法 ± 0.3		2:1		mm		13103シリーズ ソケット SERIES 13103 SOCKET	
②RETAINER : PBT樹脂,UL94 V0、ナチュラル/ PBT,UL94 V0,COLOR:NATURAL						ANGLE 角度 ± 3°		DR 2019.12.24 D.Kitazawa		DSN 2018.10.16 D.Kitazawa			
FINISH 仕上げ						3RD.ANG.PROJ. 三角法		CHK 2019.12.25 T.Sakamoto		APP 12/19 H.Kobayashi		PARTS No. 部番	
192658						RELEASED		D.K		T.S		IMSA-13103S-***-NP	
0						SCHETCHED		D.K		T.S		1 OF 1	
LTR 記号						REVISION RECORD 記		DR		CHK		DWG No. 図番	
ECN No						DATE 年月日						110-413103-415	
												REV. 1	