

DIM.A= 1.27 x No. of Spaces  
 DIM.B= DIM.A + 5.05  
 DIM.C= DIM.A + 3.85  
 \*Available in 4 ~ 26 Circuits

Material:  
 Insulation: High Temperature Plastic UL 94V-0  
 Contact: Brass

Ordering Code:

CA35 \*\* M 1 0 R P - NH  
 ① ② ③ ④ ⑤ ⑥ ⑦ ⑧

- ① Series No.:
- ② No. of Circuits: 4 ~ 26 PIN
- ③ Contacts Type: M= SMT Type
- ④ Plating option:  
 1= Matte Tin over Nickel plated
- ⑤ Color: 0= Nature
- ⑥ Packing options:  
 ④ 0= Tape & Reel (Without pick & place pad)  
 R= Tape & Reel (With pick & place pad)  
 T= Tube
- ⑦ Other Options:  
 G= Without positioning pegs, H= 4.10mm  
 D= With positioning pegs, H= 4.10mm  
 E= Without positioning pegs, H= 6.40mm  
 P= With positioning pegs, H= 6.40mm
- ⑧ NH= For Lead Free IR Processes and Halogen-Free

CVILUX  
 2021.12.30  
 ISSUED

Halogen-Free    Lead Free Process    RoHS compliant

⑤	Sun	12/23-21'	ECNT121317		DATE	UNIT: mm / inch	TITLE: 1.27mm Pitch SMT Type Connector	瀚荃股份有限公司 CviLux Corporation			
④	Karen	8/17-20'	ECNT120216/ECRB120032	DRAWN BY:	Sun	12/23-21'	TOLERANCE UNLESS OTHERWISE SPECIFIED				
③	Enya	11/8-13'	ECNT113112/ECRT113034	ENGINEER:	Sun	12/23-21'	.X ± 0.30/.012    .X' ± 1'	SCALE 4 / 1			
②	Enya	11/19-12'	ECN12290-0/ECR12086-1	CHECKED BY:	Eisley	12/24-21'	.XX ± 0.20/.008    .X' ±	SHEET 1 OF 5			
SYM	NAME	DATE	REVISIONS	APPROVED BY:	Eisley	12/24-21'	.XXX ± 0.10/.004    .XX' ±				

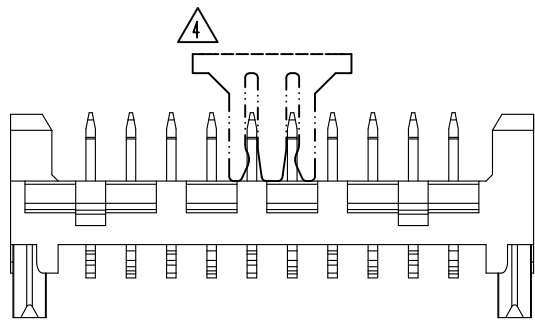

CA35\*\*M10RD-NH

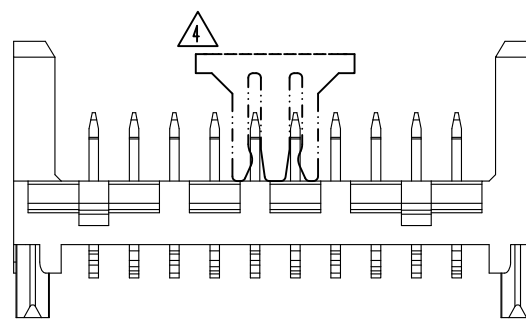
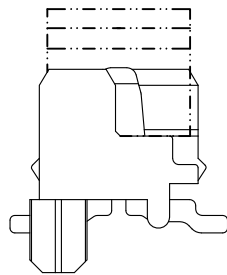

CA35\*\*M10RP-NH

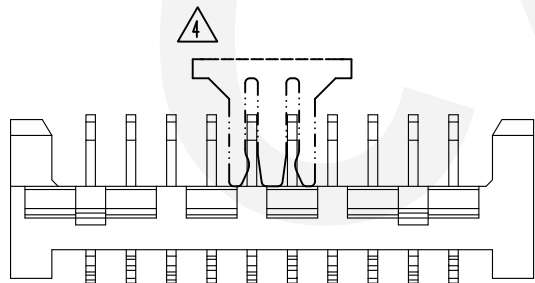
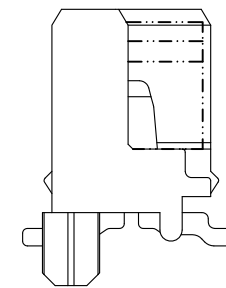

CA35\*\*M10RG-NH

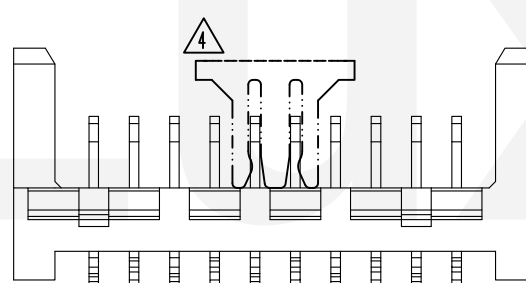
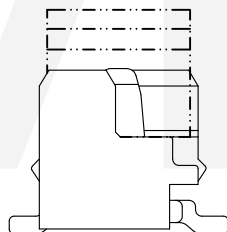

CA35\*\*M10RE-NH

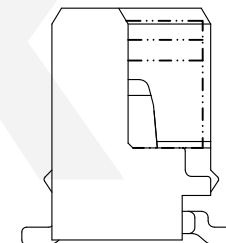

CVILUX  
2021.12.30  
ISSUED

Halogen-Free    Lead Free Process    RoHS compliant

5	Sun	12/23-21'	ECNT121317		DATE	UNIT: mm / inch	TITLE: 1.27mm Pitch SMT Type Connector	 瀚荃股份有限公司 CviLux Corporation				
4	Karen	8/17-20'	ECNT120216/ECRB120032	DRAWN BY:	Sun	12/23-21'	TOLERANCE UNLESS OTHERWISE SPECIFIED					MATERIAL:
3	Enya	11/8-13'	ECNT113112/ECRT113034	ENGINEER:	Sun	12/23-21'	.X ± 0.20/.008    .X' ± 1"	FINISH:	SCALE	4 / 1	SHEET	2 OF 5
2	Enya	11/19-12'	ECN12290-0/ECR12086-1	CHECKED BY:	Eisley	12/24-21'	.XX ± 0.10/.004    .X' ±					
SYM	NAME	DATE	REVISIONS	APPROVED BY:	Eisley	12/24-21'	.XXX ± 0.05/.002    .XX' ±					

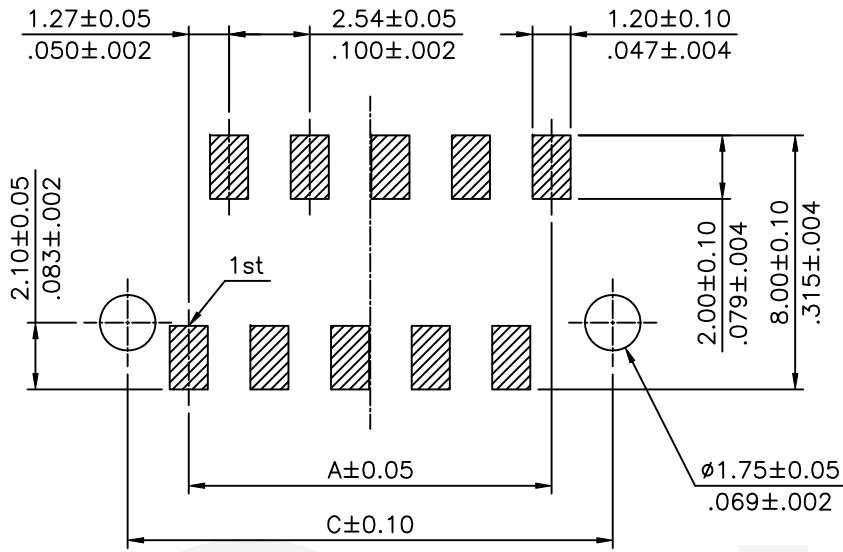

P.C.B Layout  
Transition Fit With P.C.B Pegs

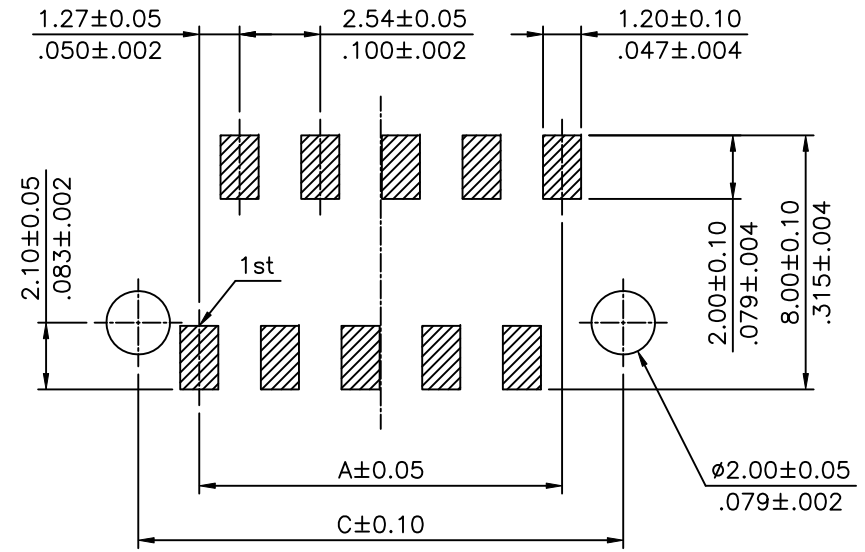

P.C.B Layout  
Clearance Fit With P.C.B Pegs

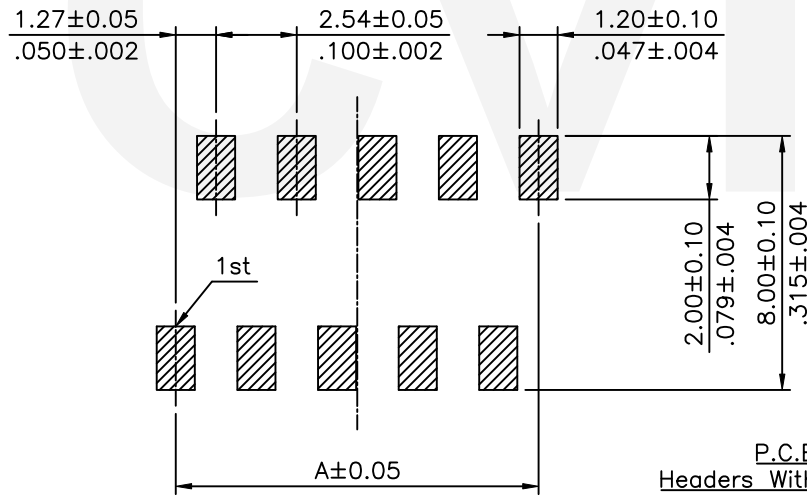

P.C.B Layout  
Headers Without P.C.B Pegs

DIM.A= 1.27 x No. of Spaces  
 DIM.B= DIM.A + 5.05  
 DIM.C= DIM.A + 3.85  
 \*Available in 4 ~ 26 Circuits

**CVILUX**  
 2021.12.30  
 ISSUED

Halogen-Free

Lead Free Process

RoHS Compliant

5	Sun	12/23-21'	ECNT121317		DATE	UNIT: mm / inch	TITLE: 1.27mm Pitch SMT Type Connector	 瀚荃股份有限公司 CviLux Corporation
4	Karen	8/17-20'	ECNT120216/ECRB120032	DRAWN BY:	Sun 12/23-21'	TOLERANCE UNLESS OTHERWISE SPECIFIED	MATERIAL:	
3	Enya	11/8-13'	ECNT113112/ECRT113034	ENGINEER:	Sun 12/23-21'	.X ± 0.30/.012 X' ± 1'	FINISH:	DRAWING NO. CA3501SF
2	Enya	11/19-12'	ECN12290-0/ECR12086-1	CHECKED BY:	Eisley 12/24-21'	.XX ± 0.20/.008 .X' ±		PART NO. CA35**M10**-NH
SYM	NAME	DATE	REVISIONS	APPROVED BY:	Eisley 12/24-21'	.XXX ± 0.10/.004 .XX' ±	SCALE 4 / 1	SHEET 3 OF 5

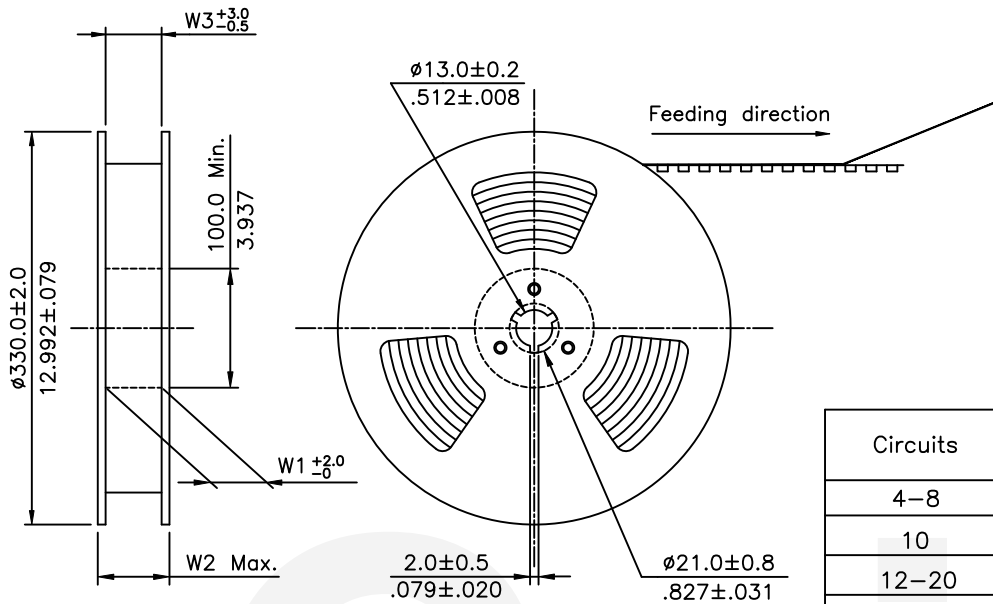

- NOTE :
- △ \* Reel Material : Corrugated Paper
  - \* Carrier Material : Transparent Anti-static Polystyrene
  - \* Cover Tape Material : Polyester
  - \* Cover Tape Peel Strength : 0.1N – 1.3N
  - \* Carrier camber is within 1mm in 100mm
  - \* Packing length per 22" reel : 24.6 Meters
  - \* Quantity : 600 PCS/Reel

Circuits	Dimension					Packing (Reel/Carton)
	E	F	W1	W2	W3	
4-8	24.0(.945)	-	24.5(.965)	30.5(1.201)	24.5(.965)	9
10	32.0(1.260)	28.40(1.118)	32.5(1.280)	38.5(1.516)	32.5(1.280)	7
12-20	44.0(1.732)	40.40(1.591)	44.5(1.752)	50.5(1.988)	44.5(1.752)	5
22-26	56.0(2.205)	52.40(2.063)	56.5(2.224)	62.5(2.461)	56.5(2.224)	3

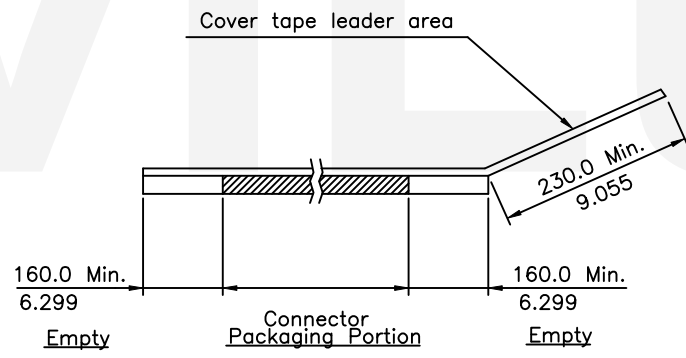

CVILUX  
 2021.12.30  
 ISSUED

RoHS Compliant

△5	Sun	12/23-21'	ECNT121317		DATE	UNIT: mm / inch	TITLE: 1.27mm Pitch SMT Type Connector	瀚荃股份有限公司 CviLux Corporation			
△4	Karen	8/17-20'	ECNT120216/ECRB120032	DRAWN BY:	Sun	12/23-21'	MATERIAL:				
△3	Enya	11/8-13'	ECNT113112/ECRT113034	ENGINEER:	Sun	12/23-21'		FINISH:	SCALE		SHEET
△2	Enya	11/19-12'	ECN12290-0/ECR12086-1	CHECKED BY:	Eisley	12/24-21'					
SYM	NAME	DATE	REVISIONS	APPROVED BY:	Eisley	12/24-21'					

CA35\*\*M10RD-NH/CA35\*\*M10RE-NH/CA35\*\*M10RP-NH

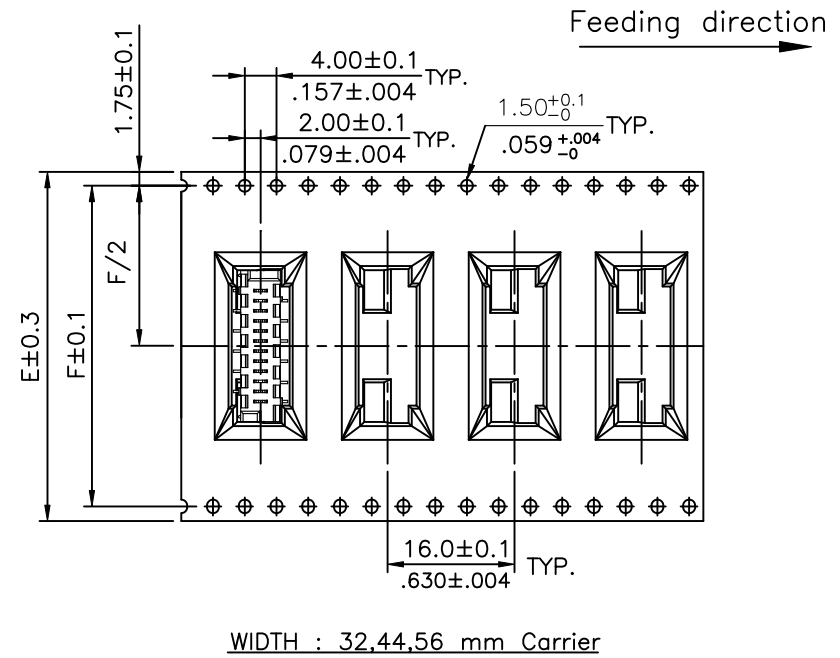
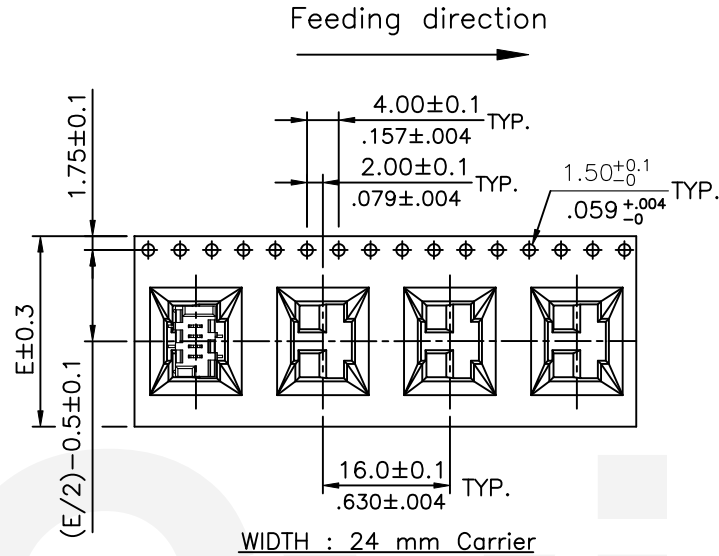

CA35\*\*M10RG-NH

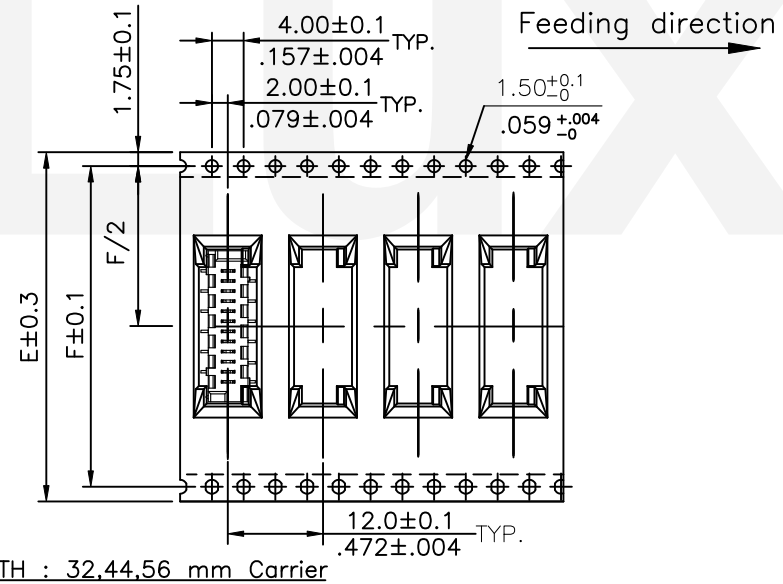
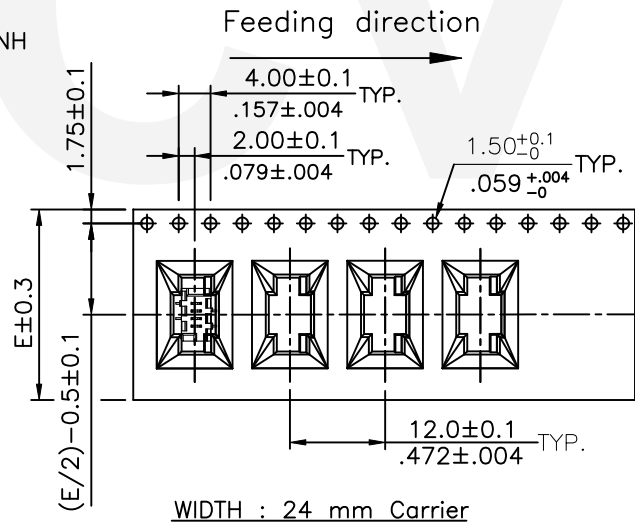

**CVILUX**  
2021.12.30  
**ISSUED**

**RoHS Compliant**

5	Sun	12/23-21'	ECNT121317		DATE	UNIT: mm / inch	TITLE: 1.27mm Pitch SMT Type Connector	 <b>瀚荃股份有限公司</b> CviLux Corporation	
4	Karen	8/17-20'	ECNT120216/ECRB120032	DRAWN BY:	Sun 12/23-21'	TOLERANCE UNLESS OTHERWISE SPECIFIED	MATERIAL:		
3	Enya	11/8-13'	ECNT113112/ECRT113034	ENGINEER:	Sun 12/23-21'	.X ±      X' ± 1'	FINISH:	DRAWING NO. CA3501SF	PART NO. CA35**M10**-NH
2	Enya	11/19-12'	ECN12290-0/ECR12086-1	CHECKED BY:	Eisley 12/24-21'	.XX ±     .X' ±		SCALE 4 / 1	SHEET 5 OF 5
SYM	NAME	DATE	REVISIONS	APPROVED BY:	Eisley 12/24-21'	.XXX ±    .XX' ±			