

Overview

The KEMET SHBC coils are normal mode chokes with a wide variety of characteristics. These coils are designed with Fe-Si-Al dust cores and are useful in various fields such as DC/DC converters and differential noise countermeasures.

Applications

- Switching power supply outlet
- DC-DC converter
- Phase compensation
- Boost converter

Benefits

- Fe-Si-Al dust core material
- Available for smoothing and converting
- Low core loss
- High frequency drive
- Wide variety of sizes and specifications
- Operating temperature range from -40°C to $+125^{\circ}\text{C}$



Part Number System

SHBC	8S-	OR6	A	0024	V
Series	Dimension Code (See Dimensions)	Wire Diameter (mm)	Windings	Inductance (μH) at 0 A $\pm 20\%$	Core Orientation
SHBC	8S 10 12 13 14 20 24N 24W	R = Decimal point Examples: OR6 = 0.6 mm 1R0 = 1.0 mm	A = Single B = Double	00xx = xx μH 0xxx = xxx μH Examples: 0024 = 24 μH 0107 = 107 μH	V = Vertical

Dimensions – Millimeters

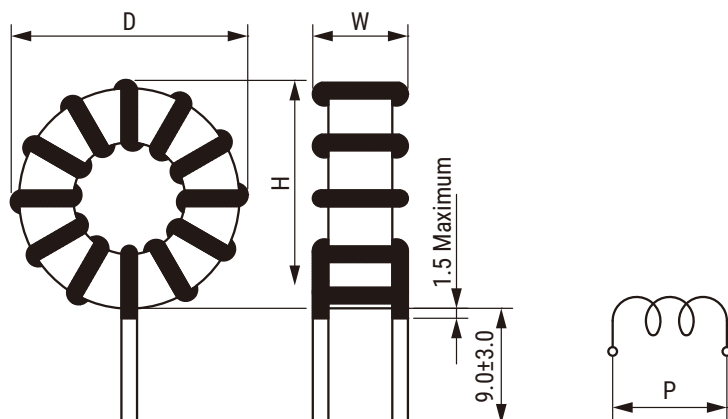

Part Number	Dimensions (mm)			
	D Maximum	W Maximum	H Maximum	P ¹ Typical
SHBC8S-0R6A0024V	16.0	8.8	16.0	7.0
SHBC8S-0R6A0043V	17.0	9.1	17.0	7.0
SHBC8S-0R6A0067V	17.0	9.6	17.0	7.5
SHBC10-0R8A0038V	21.5	11.7	21.5	8.0
SHBC10-0R8A0068V	21.5	12.3	21.5	8.0
SHBC10-0R8A0107V	22.0	12.1	22.0	9.0
SHBC12-1R0A0028V	26.0	12.1	26.0	9.0
SHBC12-1R0A0051V	26.0	12.4	26.0	9.0
SHBC12-1R0A0080V	26.4	13.3	26.4	9.5
SHBC13-1R2A0045V	30.0	14.9	30.0	11.0
SHBC13-1R2A0081V	30.0	15.7	30.0	11.0
SHBC13-1R2A0127V	30.0	16.2	30.0	12.0
SHBC14-1R2A0067V	33.5	17.1	33.5	14.0
SHBC14-1R2A0120V	34.0	18.6	34.0	15.0
SHBC14-1R2A0187V	34.0	19.4	34.0	15.0
SHBC20-1R7A0054V	41.2	19.5	41.2	14.0
SHBC20-1R7A0097V	41.2	20.3	41.2	14.0
SHBC20-1R7A0152V	41.2	20.4	41.2	15.0
SHBC24N-2R0A0219V	50.5	26.5	50.5	19.0
SHBC24W-2R1A0311V	57.6	30.5	57.6	24.0
SHBC24N-2R3A0104V	49.5	25.8	49.5	22.0
SHBC24W-2R4A0174V	57.6	30.9	57.6	24.0
SHBC24N-2R1B0039V	50.1	25.7	50.1	20.0
SHBC24W-2R1B0065V	57.6	31.2	57.6	23.0

¹ p listed above for reference only. Values not guaranteed.

Environmental Compliance

All KEMET AC Line Filters are RoHS Compliant.



Performance Characteristics

Item	Performance Characteristics
Rated Current Range	2 – 30 A
Rated Inductance Range	24 – 311 μ H at 0 A \pm 20%
Inductance Measurement Condition	100 kHz, 1 mA
Wire Type	1 UEW and 1 PEW
Operating Temperature Range	-40°C to +125°C (include self temperature rise)

Table 1 – Ratings & Part Number Reference

Part Number	Rated Current (A)	Inductance (μ H)		DC Resistance/ Line (m Ω) Maximum	Temperature Rise ¹ (K) Maximum	Wire Diameter (mm)	Weight (g) Approximate
		at 0 A \pm 20%	Rated current \pm 25%				
SHBC8S-0R6A0024V	2	24	22.1	41.1	15	0.6	4
SHBC8S-0R6A0043V	2	43	36.9	54.1	20	0.6	4
SHBC8S-0R6A0067V	2	67	55.0	67.8	25	0.6	4
SHBC10-0R8A0038V	3	38	32.5	31.2	15	0.8	9
SHBC10-0R8A0068V	3	68	58.4	42.3	20	0.8	10
SHBC10-0R8A0107V	3	107	85.2	53.0	25	0.8	11
SHBC12-1R0A0028V	5	28	24.9	21.1	25	1.0	13
SHBC12-1R0A0051V	5	51	40.7	28.0	25	1.0	14
SHBC12-1R0A0080V	5	80	58.5	35.6	40	1.0	16
SHBC13-1R2A0045V	6	45	37.3	18.3	25	1.2	23
SHBC13-1R2A0081V	6	81	60.5	24.7	30	1.2	26
SHBC13-1R2A0127V	6	127	84.8	31.7	35	1.2	30
SHBC14-1R2A0067V	8	67	53.3	22.2	40	1.2	37
SHBC14-1R2A0120V	8	120	84.3	29.9	50	1.2	41
SHBC14-1R2A0187V	8	187	113.5	37.6	60	1.2	45
SHBC20-1R7A0054V	12	54	40.4	11.5	35	1.7	56
SHBC20-1R7A0097V	12	97	61.5	16.0	45	1.7	65
SHBC20-1R7A0152V	12	152	80.0	20.4	60	1.7	72
SHBC24N-2R0A0219V	15	219	102.6	19.5	65	2.0	137
SHBC24W-2R1A0311V	15	311	182.5	20.1	55	2.1	224
SHBC24N-2R3A0104V	20	104	53.4	10.4	55	2.3	133
SHBC24W-2R4A0174V	20	174	102.7	11.8	50	2.4	222
SHBC24N-2R1B0039V	30	39	21.2	6.8	50	2.1 x 2 Parallel	135
SHBC24W-2R1B0065V	30	65	40.7	6.2	50	2.1 x 2 Parallel	217

¹ The temperature rise during mounting is affected by the mounted coil and the harmonic components of the electric current. When selecting a product, please make sure that the coil temperature will not exceed the listed operating temperature range under planned operating conditions.

DC-Superposed Characteristics

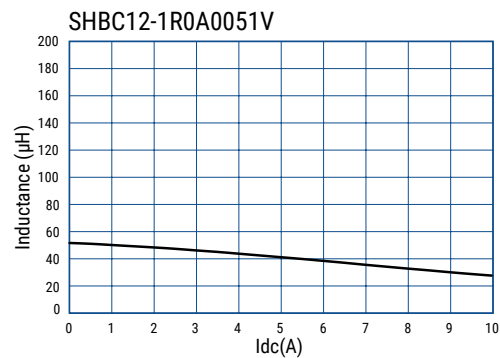
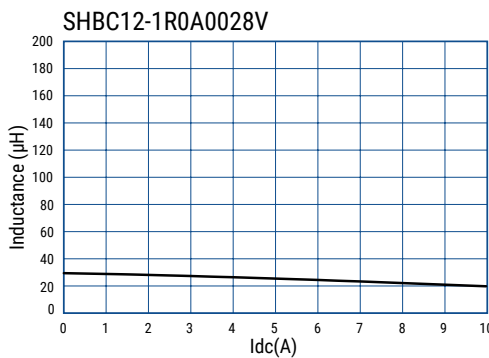
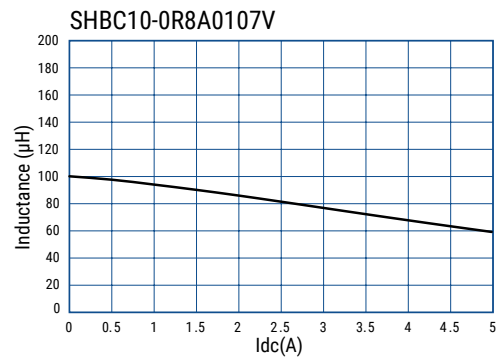
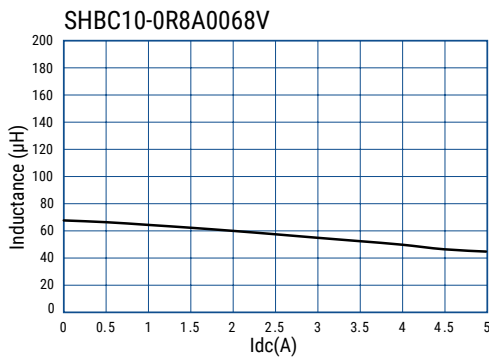
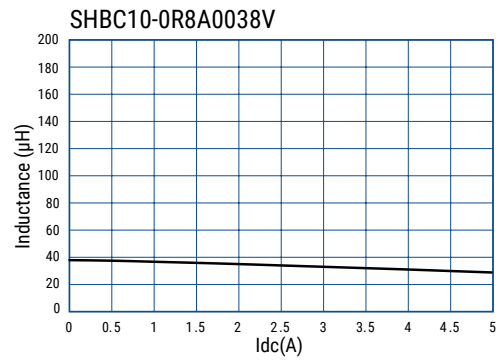
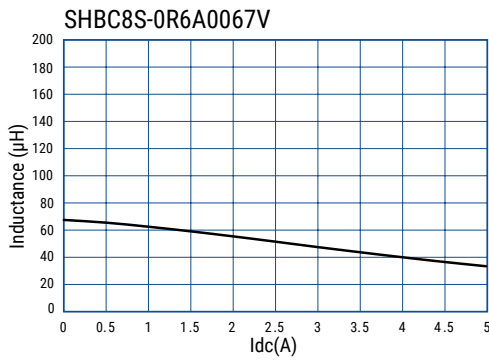
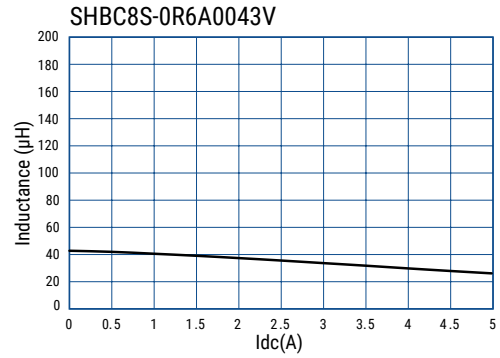
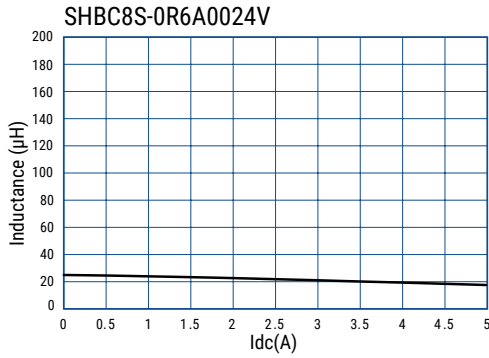

DC-Superposed Characteristics cont.

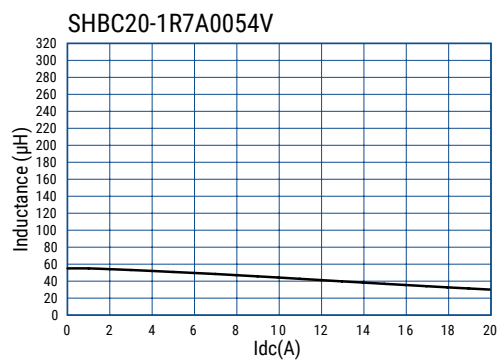
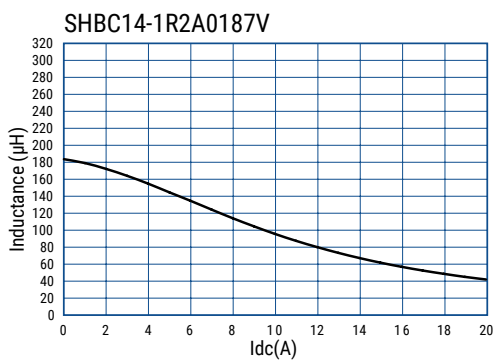
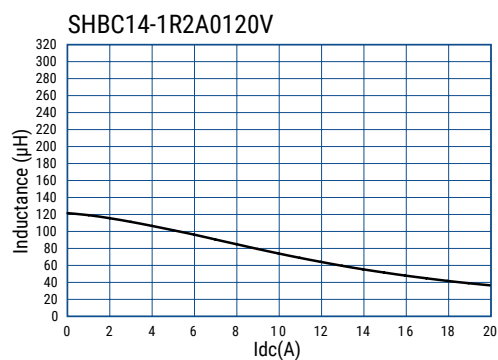
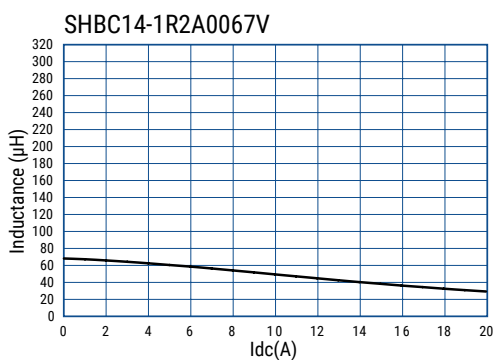
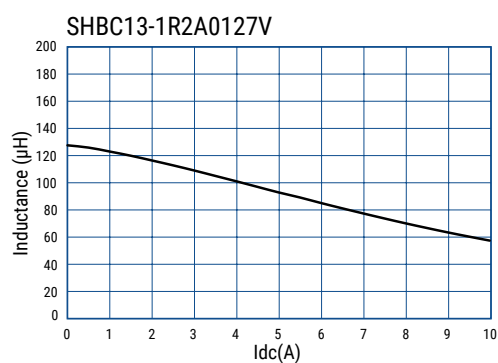
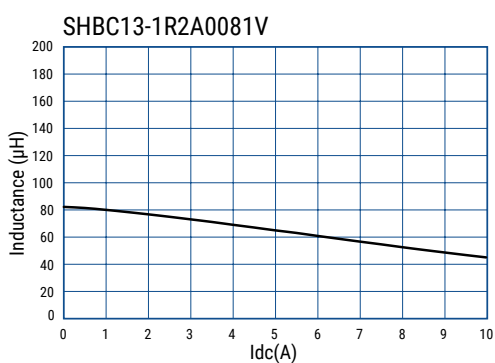
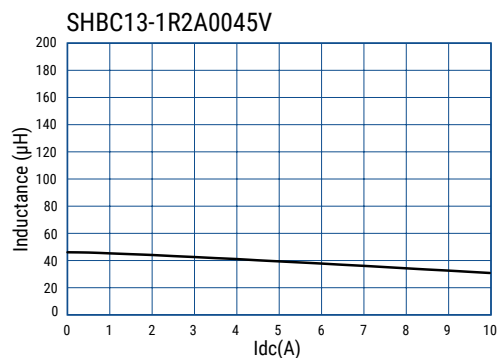
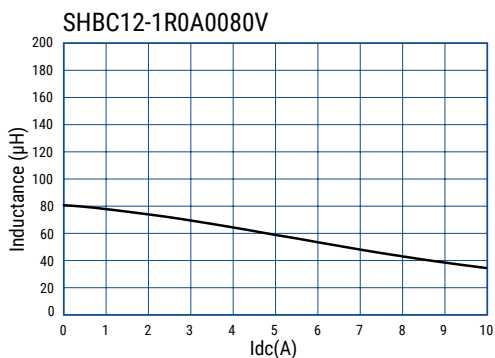

DC-Superposed Characteristics cont.

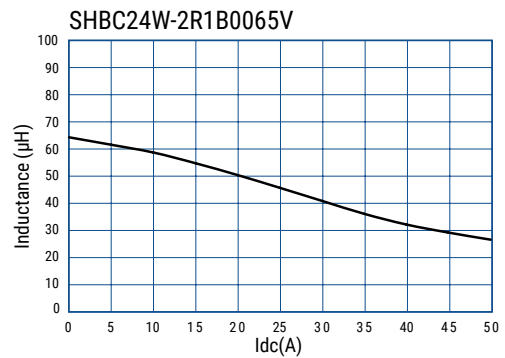
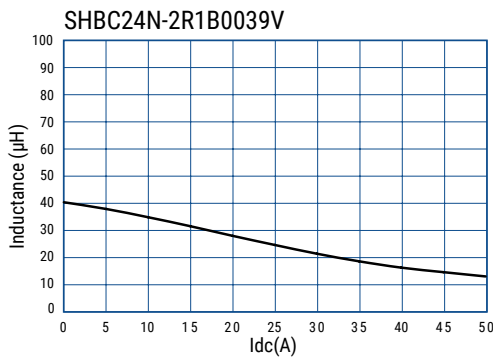
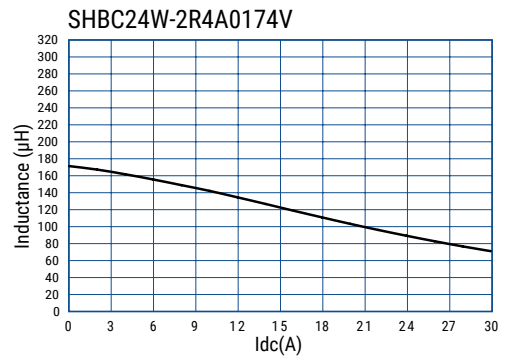
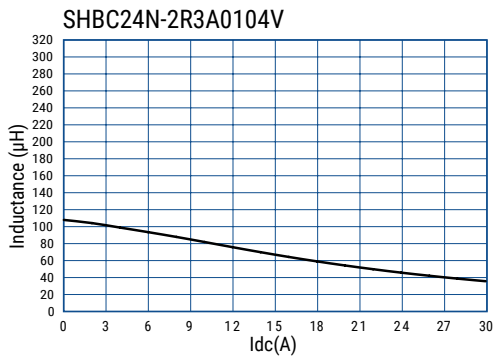
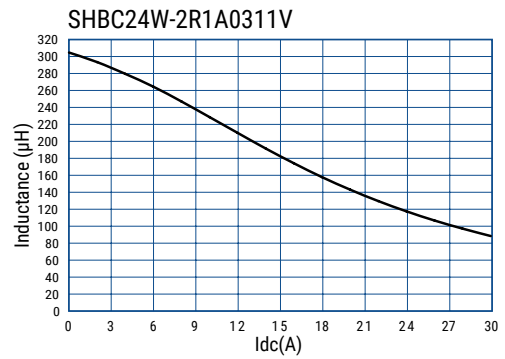
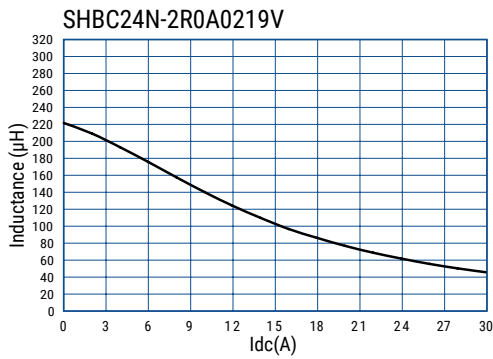
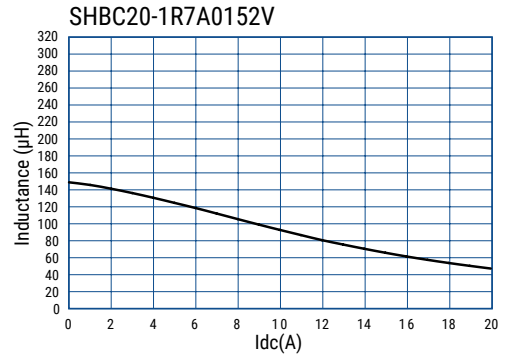
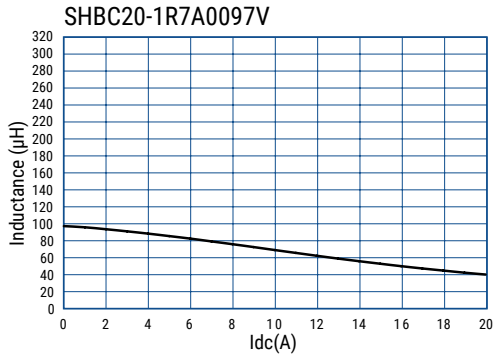

Inductance Characteristics

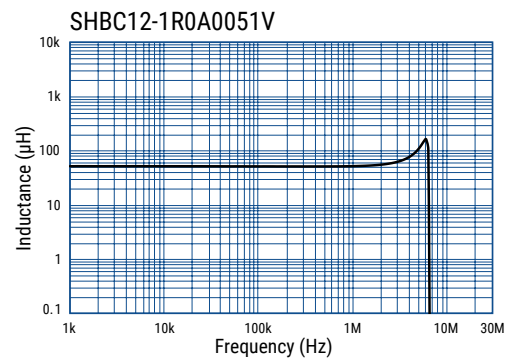
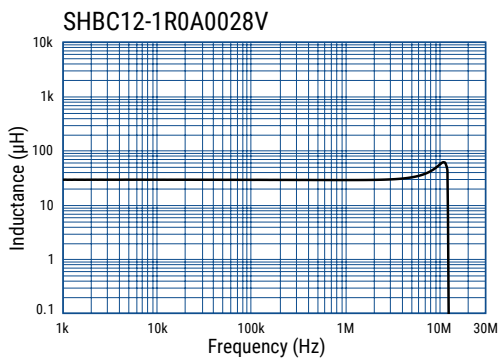
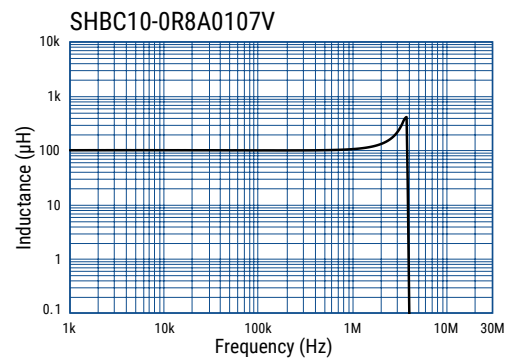
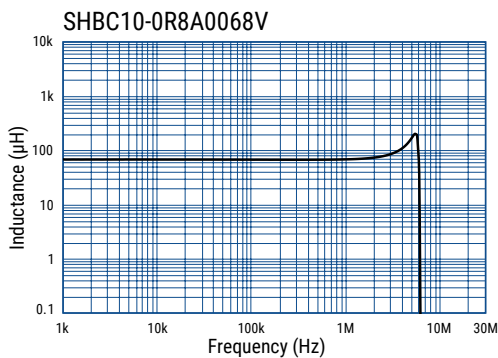
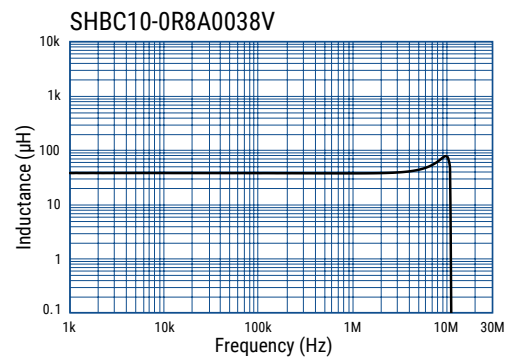
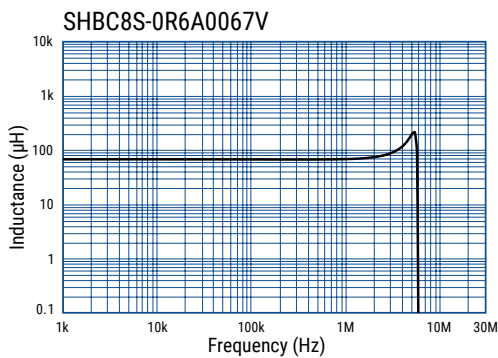
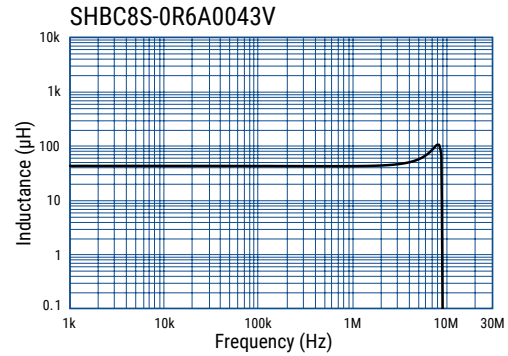
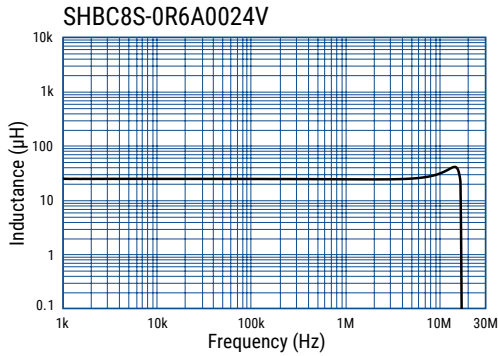

Inductance Characteristics cont.

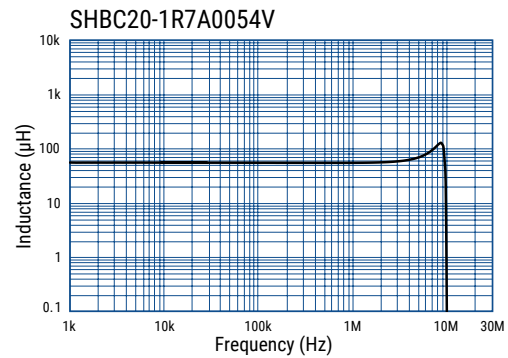
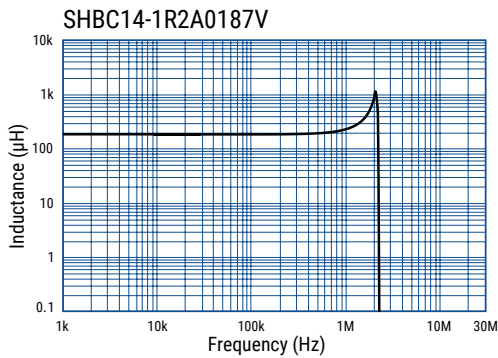
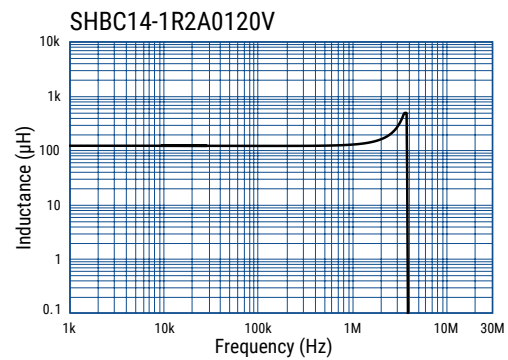
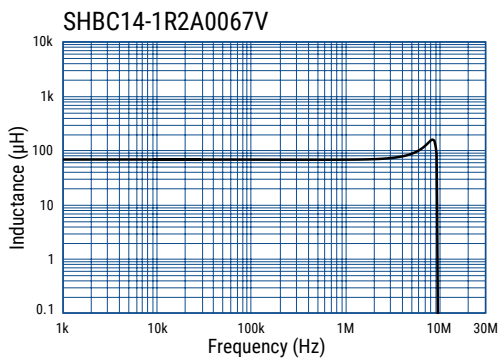
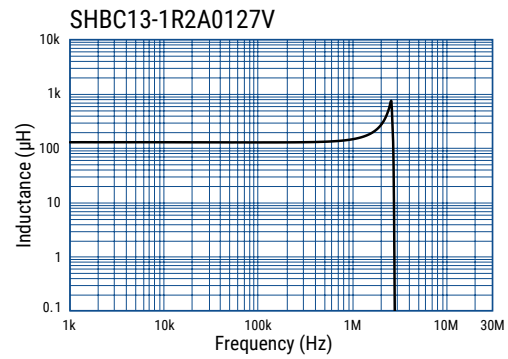
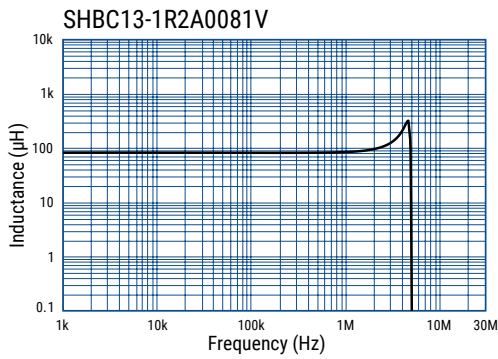
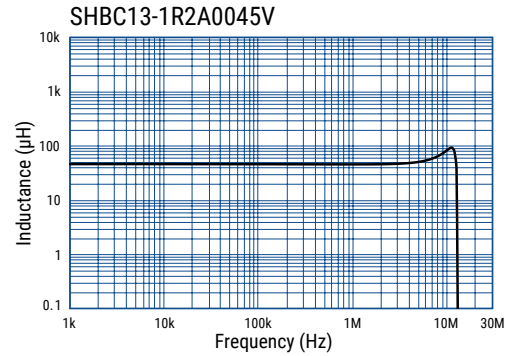
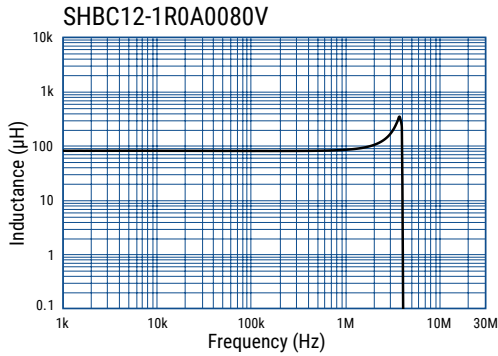

Inductance Characteristics cont.

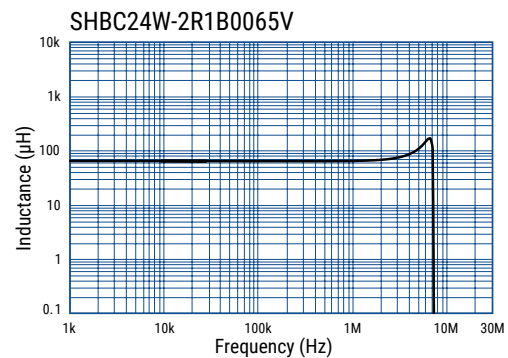
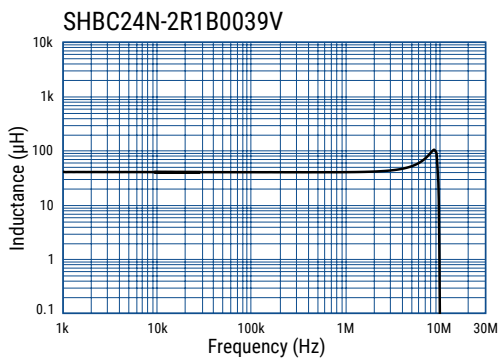
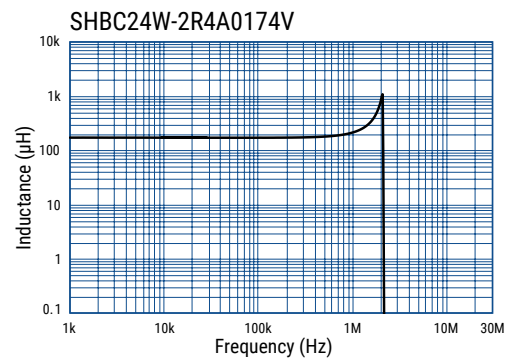
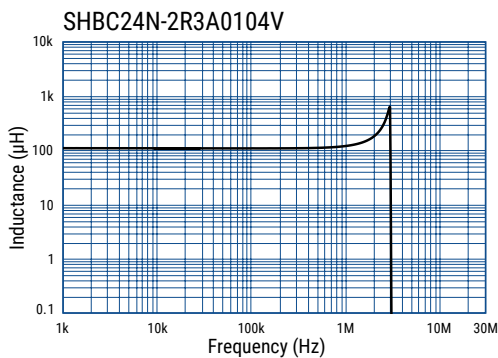
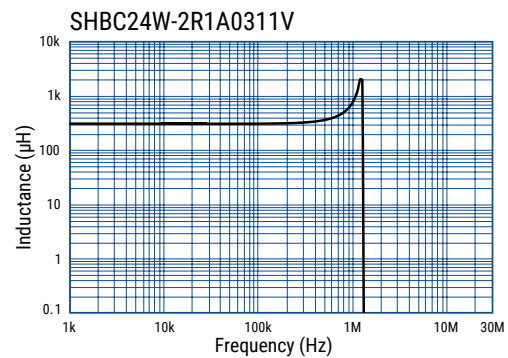
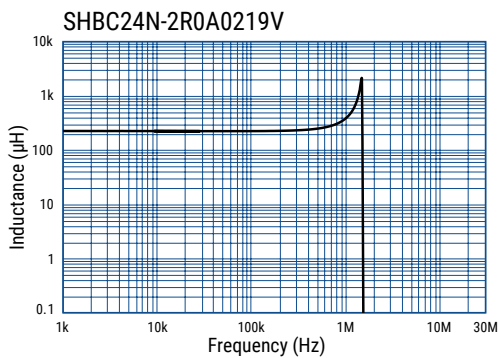
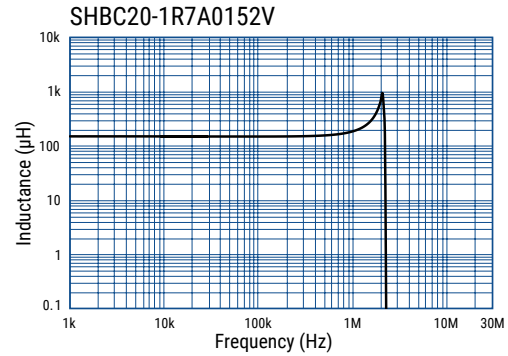
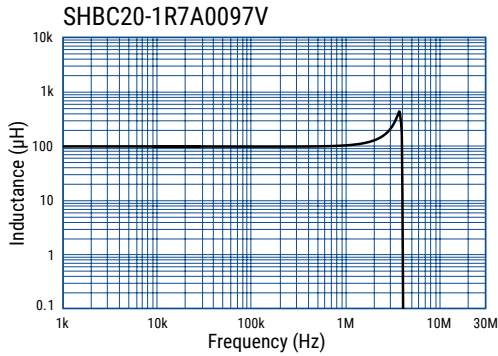

Frequency Characteristics

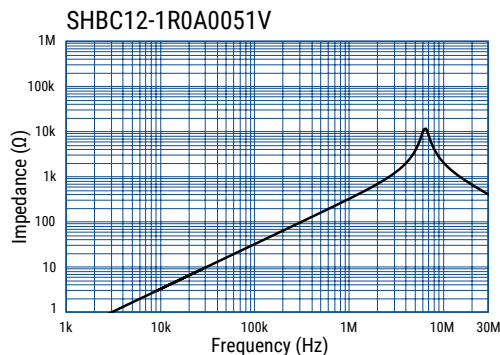
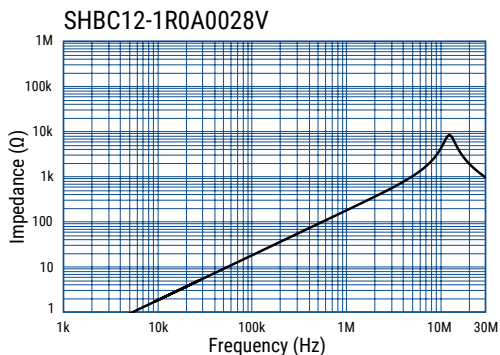
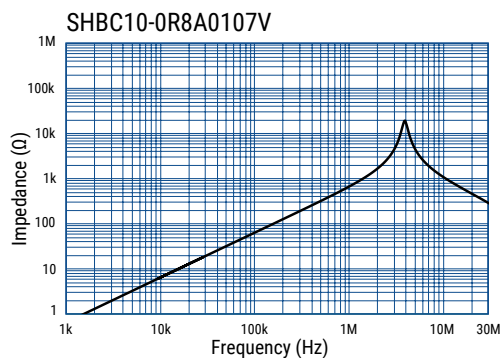
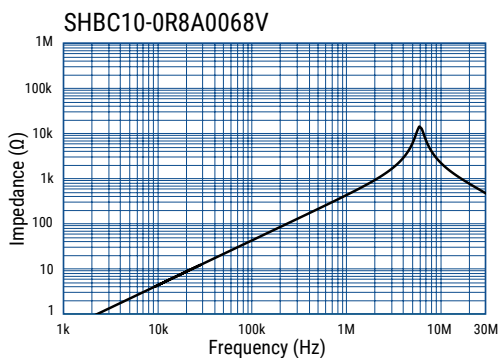
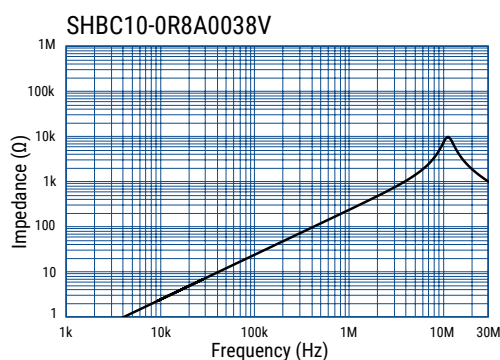
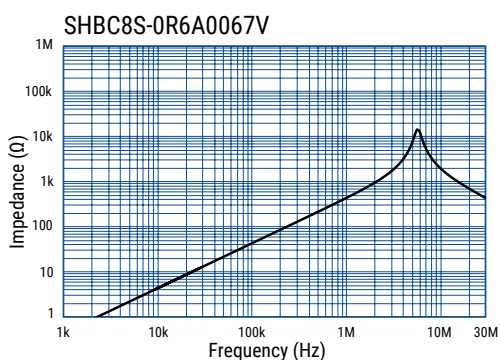
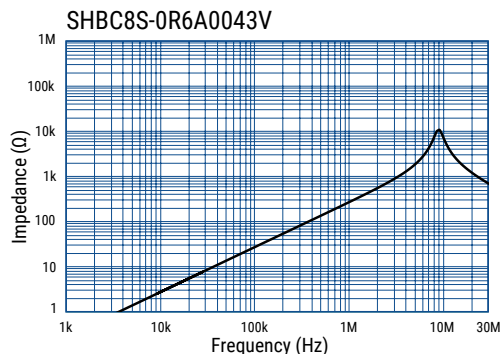
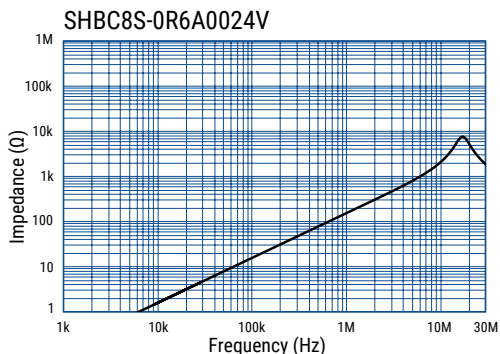

Frequency Characteristics cont.

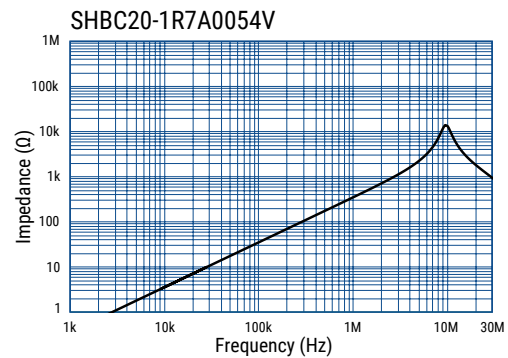
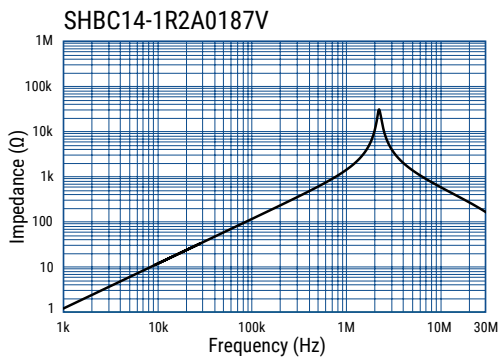
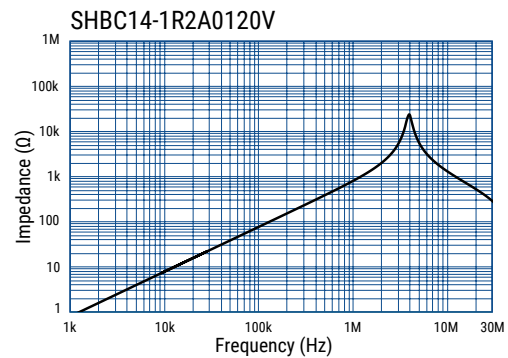
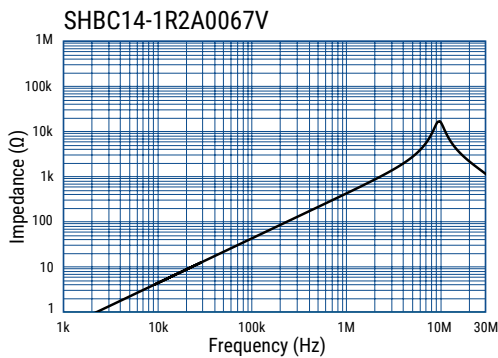
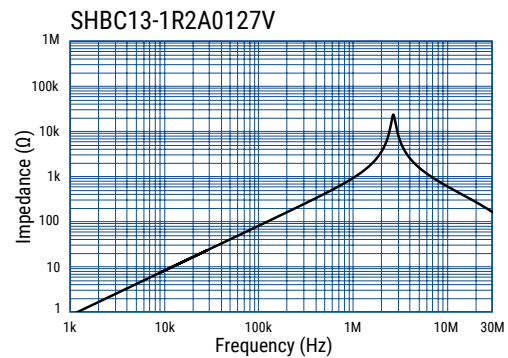
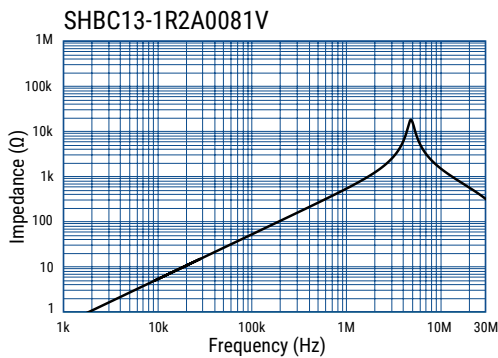
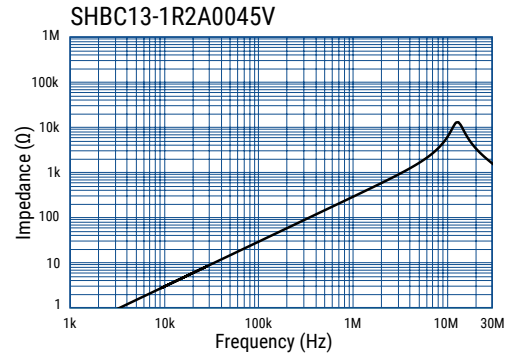
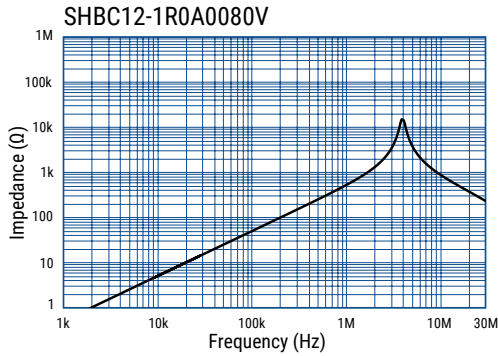

Frequency Characteristics cont.

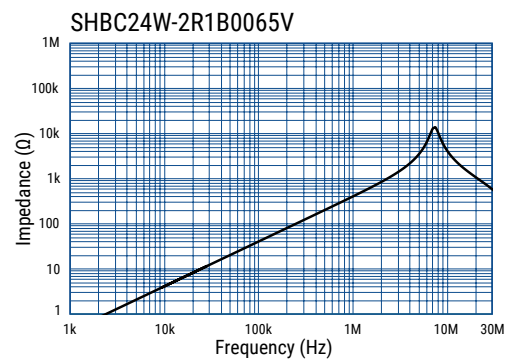
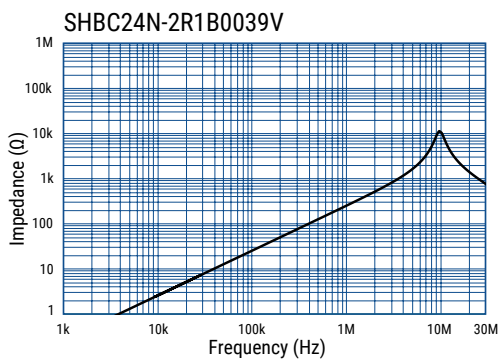
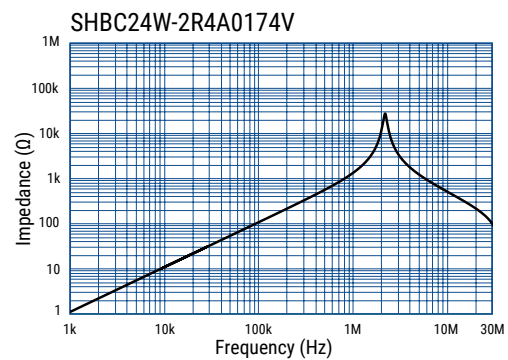
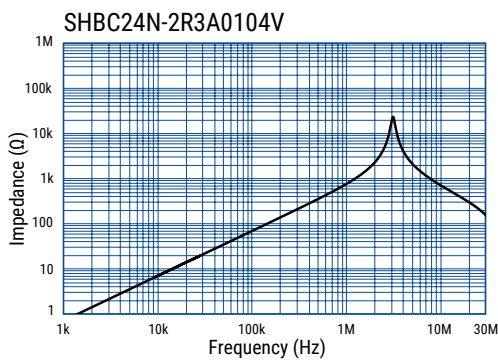
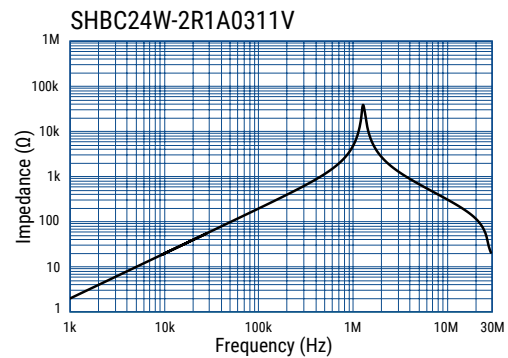
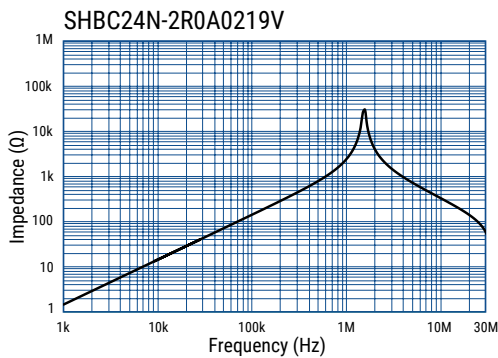
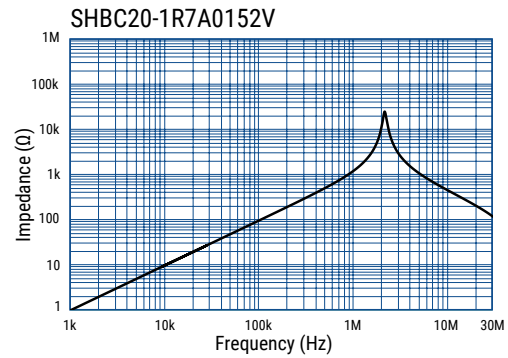
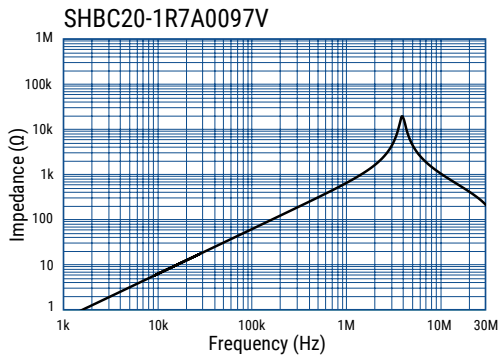

Packaging

Type	Packaging Type	Pieces Per Box
SHBC8S	Tray	700
SHBC10		240
SHBC12		150
SHBC13		120
SHBC14		80
SHBC20		60
SHBC24N		45
SHBC24W		

Handling Precautions

Precautions for product storage

AC Line Filters should be stored in normal working environments. While the chokes themselves are quite robust in other environments, solderability will be degraded by exposure to high temperatures, high humidity, corrosive atmospheres, and long term storage.

KEMET recommends that maximum storage temperature not exceed 40°C and maximum storage humidity not exceed 70% relative humidity. Atmospheres should be free of chlorine and sulfur bearing compounds. Temperature fluctuations should be minimized to avoid condensation on the parts. Avoid storage near strong magnetic fields, as this might magnetize the product.

For optimized solderability, AC line filters stock should be used promptly and preferably within 6 months of receipt.

Product temperature rise values

The values listed for temperature rise are the result of self-heating in wires when the rated current (commercial frequency) is applied.

When using the product, check and evaluate the value of the core temperature rise under actual operating conditions.

KEMET Electronics Corporation Sales Offices

For a complete list of our global sales offices, please visit www.kemet.com/sales.

Disclaimer

YAGEO Corporation and its affiliates do not recommend the use of commercial or automotive grade products for high reliability applications or manned space flight.

All product specifications, statements, information and data (collectively, the "Information") in this datasheet are subject to change. The customer is responsible for checking and verifying the extent to which the Information contained in this publication is applicable to an order at the time the order is placed. All Information given herein is believed to be accurate and reliable, but it is presented without guarantee, warranty, or responsibility of any kind, expressed or implied.

Statements of suitability for certain applications are based on KEMET Electronics Corporation's ("KEMET") knowledge of typical operating conditions for such applications, but are not intended to constitute – and KEMET specifically disclaims – any warranty concerning suitability for a specific customer application or use. The Information is intended for use only by customers who have the requisite experience and capability to determine the correct products for their application. Any technical advice inferred from this Information or otherwise provided by KEMET with reference to the use of KEMET's products is given gratis, and KEMET assumes no obligation or liability for the advice given or results obtained.

Although KEMET designs and manufactures its products to the most stringent quality and safety standards, given the current state of the art, isolated component failures may still occur. Accordingly, customer applications which require a high degree of reliability or safety should employ suitable designs or other safeguards (such as installation of protective circuitry or redundancies) in order to ensure that the failure of an electrical component does not result in a risk of personal injury or property damage.

Although all product-related warnings, cautions and notes must be observed, the customer should not assume that all safety measures are indicated or that other measures may not be required.

When providing KEMET products and technologies contained herein to other countries, the customer must abide by the procedures and provisions stipulated in all applicable export laws and regulations, including without limitation the International Traffic in Arms Regulations (ITAR), the US Export Administration Regulations (EAR) and the Japan Foreign Exchange and Foreign Trade Act.

KEMET is a registered trademark of KEMET Electronics Corporation.