

Power Inductor

HPC-BM/NF/NC-SERIES

1、Features

1. This specification applies Low Profile Power Inductors.
2. 100% Lead(Pb) & Halogen-Free and RoHS compliant.



2、Applications

Commercial applications

3、Dimension

Recommended Land pattern

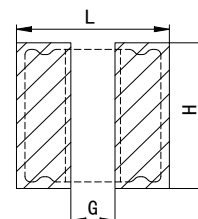
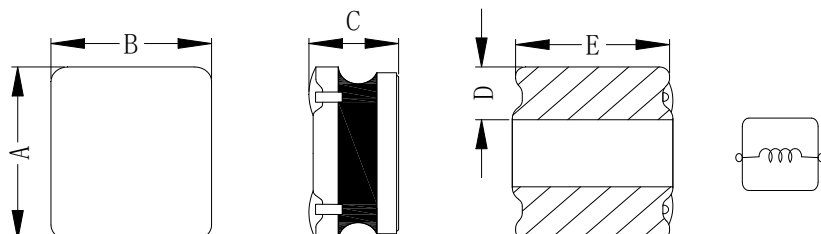

Series	*A(mm)	*B(mm)	*C(mm)	D(mm)	E(mm)
HPC201608BM	2.0±0.2	1.6±0.2	0.7±0.1	0.7±0.3	1.8±0.3

L(mm)	G(mm)	H(mm)
2.5	0.5	2.1

*Dimensions are not including the termination. For maximum overall dimensions with termination, add 0.1mm.

Note: 1. The above PCB layout referNve only.
2. Recommend solder paste thickness at 0.12mm and above.

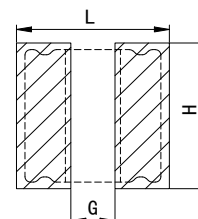
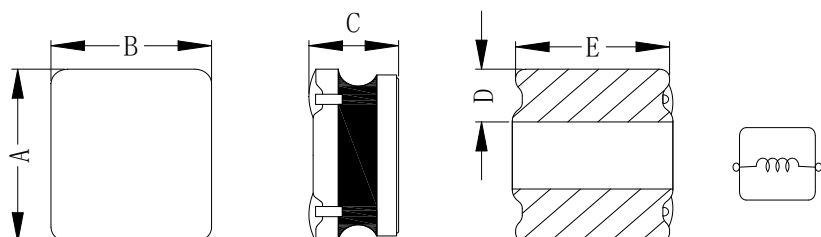

Series	*A(mm)	*B(mm)	*C(mm)	D(mm)	E(mm)
HPC201610BM	2.0±0.2	1.6±0.2	0.9±0.1	0.7±0.3	1.6±0.2

L(mm)	G(mm)	H(mm)
2.5	0.5	2.1

*Dimensions are not including the termination. For maximum overall dimensions with termination, add 0.1mm.

Note: 1. The above PCB layout referNve only.
2. Recommend solder paste thickness at 0.12mm and above.

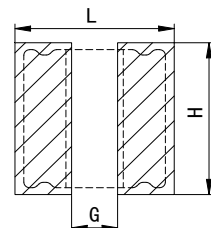
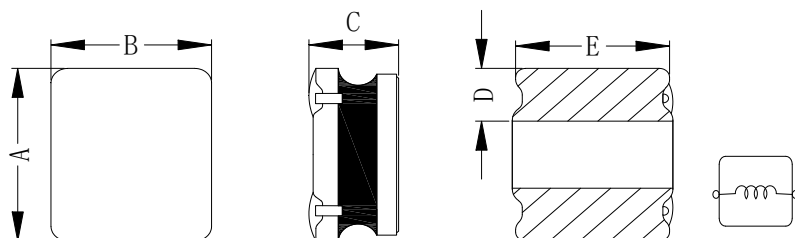

Series	*A(mm)	*B(mm)	*C(mm)	D(mm)	E(mm)
HPC201612BM	2.0±0.2	1.6±0.2	1.0±0.2	0.7±0.3	1.6±0.2

L(mm)	G(mm)	H(mm)
2.5	0.5	2.1

*Dimensions are not including the termination. For maximum overall dimensions with termination, add 0.1mm.

Note: 1. The above PCB layout referNve only.
2. Recommend solder paste thickness at 0.12mm and above.

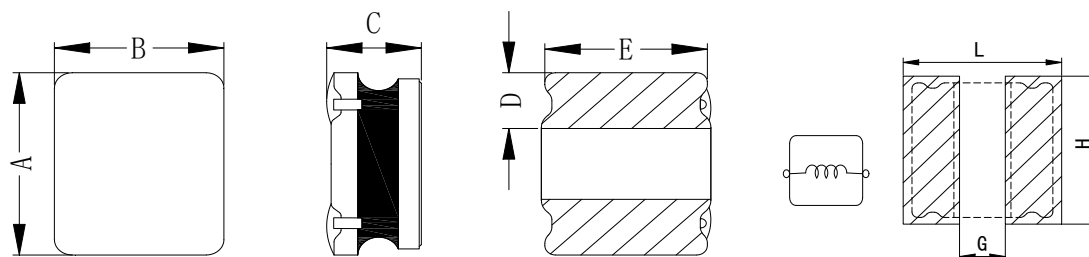

Series	*A(mm)	*B(mm)	*C(mm)	D(mm)	E(mm)
HPC252008BM	2.5±0.2	2.0±0.2	0.7±0.1	0.9±0.3	2.0±0.2

*Dimensions are not including the termination. For maximum overall dimensions with termination, add 0.1mm.

L(mm)	G(mm)	H(mm)
3.0	0.7	2.5

Note: 1. The above PCB layout refer to NVe only.
2. Recommend solder paste thickness at 0.12mm and above.

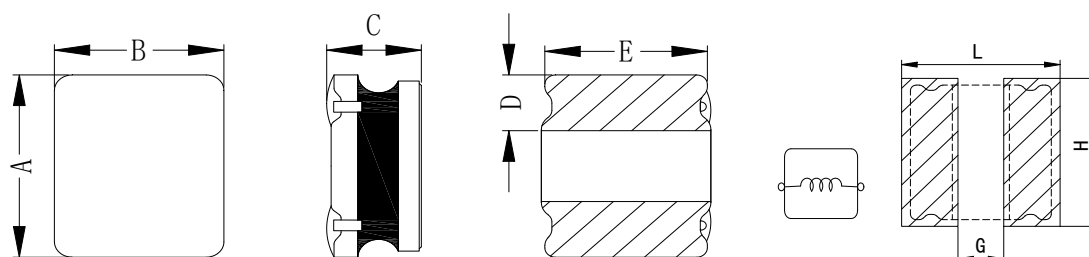

Series	*A(mm)	*B(mm)	*C(mm)	D(mm)	E(mm)
HPC252010BM	2.5±0.2	2.0±0.2	0.9±0.1	0.9±0.3	2.0±0.2

*Dimensions are not including the termination. For maximum overall dimensions with termination, add 0.1mm.

L(mm)	G(mm)	H(mm)
3.0	0.7	2.5

Note: 1. The above PCB layout refer to NVe only.
2. Recommend solder paste thickness at 0.12mm and above.

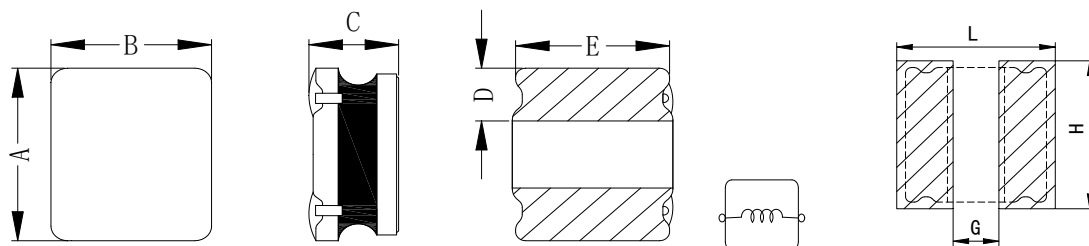

Series	*A(mm)	*B(mm)	*C(mm)	D(mm)	E(mm)
HPC252012BM	2.5±0.2	2.0±0.2	1.0±0.2	0.9±0.3	2.0±0.2

*Dimensions are not including the termination. For maximum overall dimensions with termination, add 0.1mm.

L(mm)	G(mm)	H(mm)
3.0	0.7	2.5

Note: 1. The above PCB layout refer to NVe only.
2. Recommend solder paste thickness at 0.12mm and above.

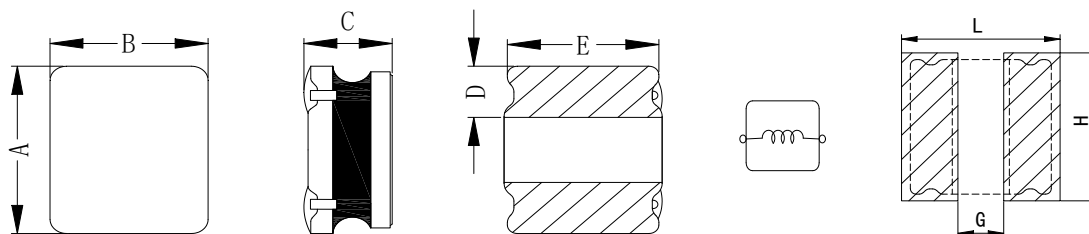

Series	*A(mm)	*B(mm)	*C(mm)	D(mm)	E(mm)
HPC322512BM	3.2±0.2	2.5±0.2	1.0±0.2	1.0±0.3	2.5±0.2

*Dimensions are not including the termination. For maximum overall dimensions with termination, add 0.1mm.

L(mm)	G(mm)	H(mm)
3.5	1.0	3.0

Note: 1. The above PCB layout refer to NVe only.
2. Recommend solder paste thickness at 0.12mm and above.

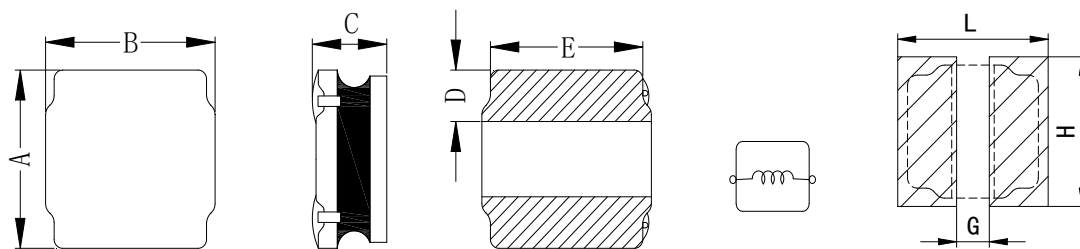

Series	*A(mm)	*B(mm)	*C(mm)	D(mm)	E(mm)
HPC3010BM	3.0±0.2	3.0±0.2	0.9±0.1	0.9±0.3	2.7±0.3

*Dimensions are not including the termination. For maximum overall dimensions with termination, add 0.1mm.

L(mm)	G(mm)	H(mm)
3.5	0.9	3.5

Note: 1. The above PCB layout refer to NVe only.
2. Recommend solder paste thickness at 0.12mm and above.

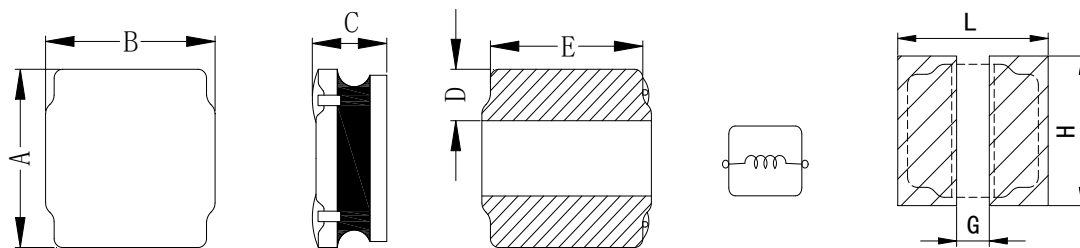

Series	*A(mm)	*B(mm)	*C(mm)	D(mm)	E(mm)
HPC3012BM	3.0±0.2	3.0±0.2	1.0±0.2	0.9±0.3	2.7±0.3

*Dimensions are not including the termination. For maximum overall dimensions with termination, add 0.1mm.

L(mm)	G(mm)	H(mm)
3.5	0.9	3.5

Note: 1. The above PCB layout refer to NVe only.
2. Recommend solder paste thickness at 0.12mm and above.

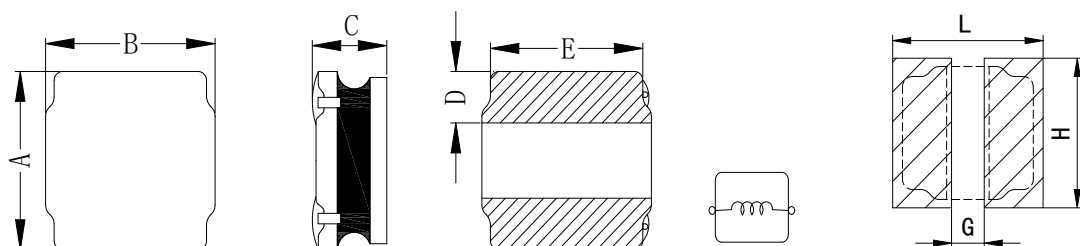

Series	*A(mm)	*B(mm)	*C(mm)	D(mm)	E(mm)
HPC3015BM	3.0±0.2	3.0±0.2	1.3±0.2	0.9±0.3	2.7±0.3

*Dimensions are not including the termination. For maximum overall dimensions with termination, add 0.1mm.

L(mm)	G(mm)	H(mm)
3.5	0.9	3.5

Note: 1. The above PCB layout refer to NVe only.
2. Recommend solder paste thickness at 0.15mm and above.

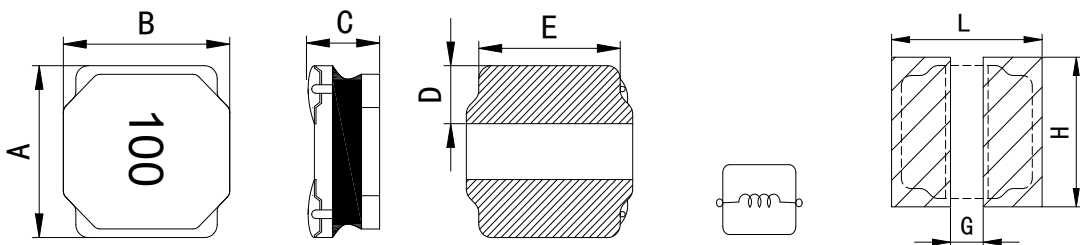

Series	*A(mm)	*B(mm)	*C(mm)	D(mm)	E(mm)
HPC3612BM	3.6±0.2	3.6±0.2	1.0±0.2	1.2±0.3	3.2±0.3

*Dimensions are not including the termination. For maximum overall dimensions with termination, add 0.1mm.

L(mm)	G(mm)	H(mm)
3.8	2.0	3.7

Note: 1. The above PCB layout refer to NVe only.
2. Recommend solder paste thickness at 0.12mm and above.

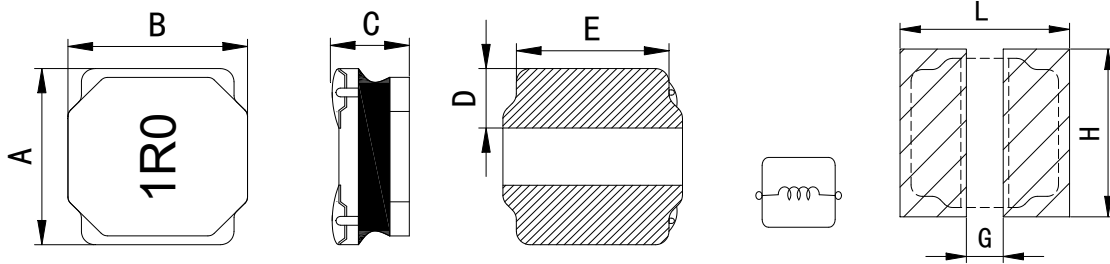

Series	*A(mm)	*B(mm)	*C(mm)	D(mm)	E(mm)
HPC4010BM	4.0±0.2	4.0±0.2	0.9±0.1	1.2±0.3	3.5±0.3

*Dimensions are not including the termination. For maximum overall dimensions with termination, add 0.1mm.

L(mm)	G(mm)	H(mm)
4.5	1.5	4.5

Note: 1. The above PCB layout refer NVe only.
2. Recommend solder paste thickness at 0.12mm and above.

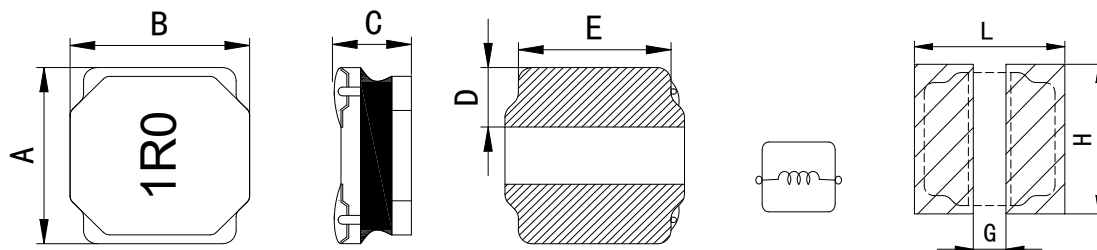

Series	*A(mm)	*B(mm)	*C(mm)	D(mm)	E(mm)
HPC4012BM	4.0±0.2	4.0±0.2	1.0±0.2	1.2±0.3	3.5±0.3

*Dimensions are not including the termination. For maximum overall dimensions with termination, add 0.1mm.

L(mm)	G(mm)	H(mm)
4.5	1.5	4.5

Note: 1. The above PCB layout refer NVe only.
2. Recommend solder paste thickness at 0.12mm and above.

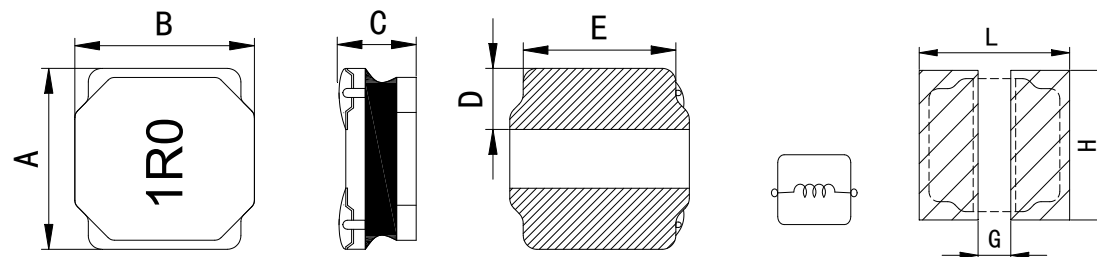

Series	A(mm)	B(mm)	C(mm)	D(mm)	E(mm)
HPC4018BM	4.0±0.2	4.0±0.2	1.6±0.2	1.1±0.2	3.5±0.3

*Dimensions are not including the termination. For maximum overall dimensions with termination, add 0.1mm.

L(mm)	G(mm)	H(mm)
4.5	1.5	4.5

Note: 1. The above PCB layout refer NVe only.
2. Recommend solder paste thickness at 0.15mm and above.

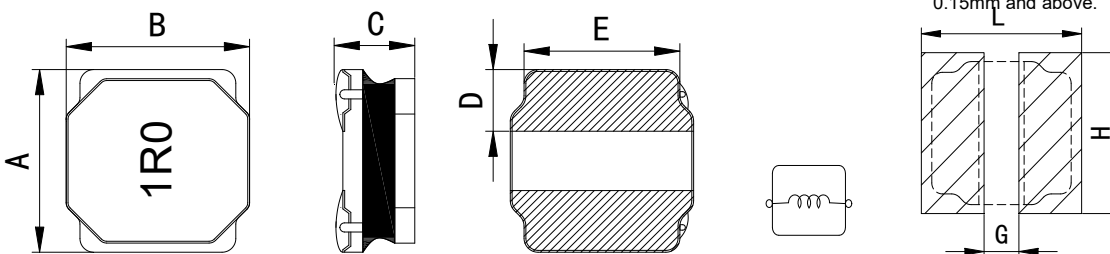

Series	A(mm)	B(mm)	C(mm)	D(mm)	E(mm)
HPC4020BM	4.0±0.2	4.0±0.2	1.8±0.2	1.2±0.3	3.4±0.3

*Dimensions are not including the termination. For maximum overall dimensions with termination, add 0.1mm.

L(mm)	G(mm)	H(mm)
4.5	1.5	4.5

Note: 1. The above PCB layout refer NVe only.
2. Recommend solder paste thickness at 0.15mm and above.

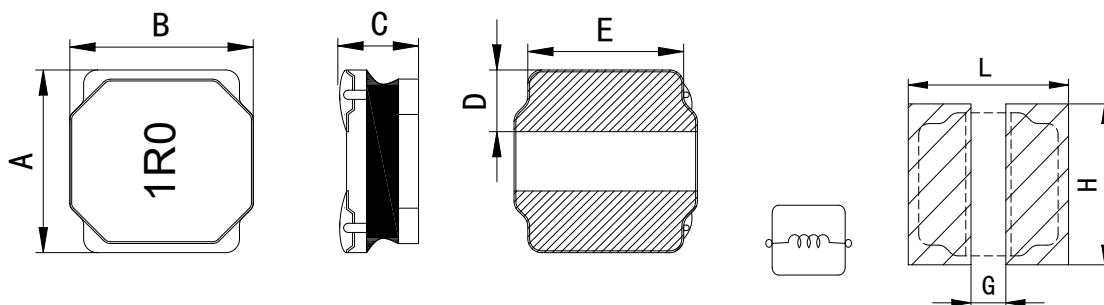

Series	*A(mm)	*B(mm)	C(mm)	D(mm)	E(mm)
HPC4030NF	4.0±0.2	4.0±0.2	2.8±0.2	1.35±0.3	3.4±0.3

L(mm)	G(mm)	H(mm)
4.5	1.5	4.5

*Dimensions are not including the termination. For maximum overall dimensions with termination, add 0.1mm.

Note: 1. The above PCB layout reference only.
2. Recommend solder paste thickness at 0.15mm and above.

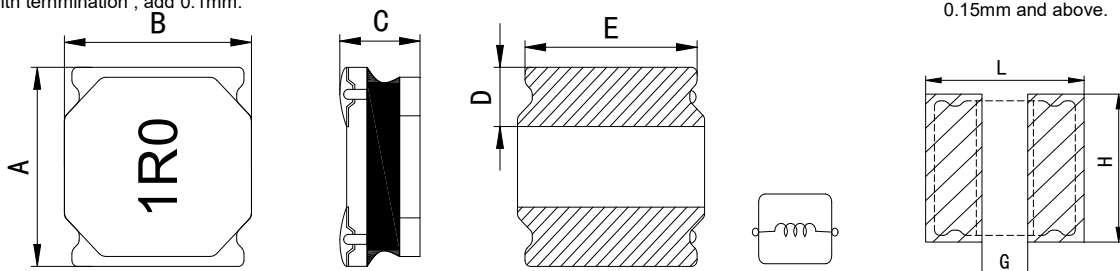

Series	*A(mm)	*B(mm)	*C(mm)	D(mm)	E(mm)
HPC5010NF	5.0±0.2	5.0±0.2	0.9±0.1	1.5±0.3	4.0±0.3

L(mm)	G(mm)	H(mm)
5.5	1.8	5.5

*Dimensions are not including the termination. For maximum overall dimensions with termination, add 0.1mm.

Note: 1. The above PCB layout reference only.
2. Recommend solder paste thickness at 0.12mm and above.

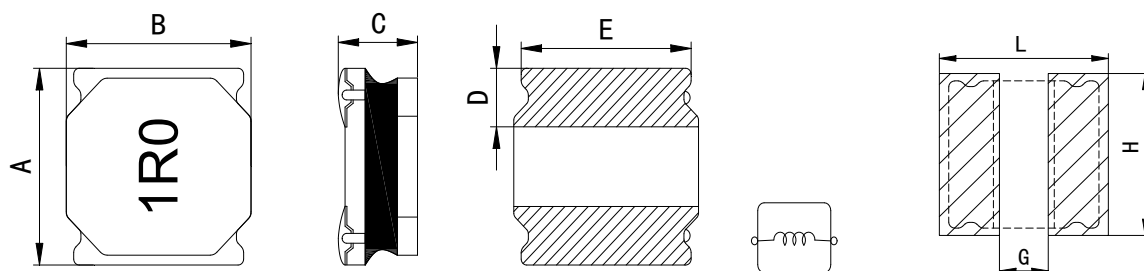

Series	*A(mm)	*B(mm)	*C(mm)	D(mm)	E(mm)
HPC5012NF	5.0±0.2	5.0±0.2	1.0±0.2	1.5±0.3	4.0±0.3

L(mm)	G(mm)	H(mm)
5.5	1.8	5.5

*Dimensions are not including the termination. For maximum overall dimensions with termination, add 0.1mm.

Note: 1. The above PCB layout reference only.
2. Recommend solder paste thickness at 0.12mm and above.

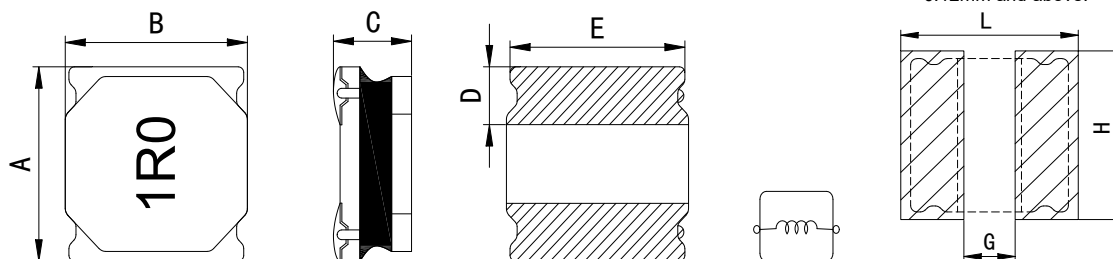

Series	*A(mm)	*B(mm)	*C(mm)	D(mm)	E(mm)
HPC5020NF	5.0±0.2	5.0±0.2	1.8±0.2	1.3±0.2	4.7±0.2

L(mm)	G(mm)	H(mm)
5.5	1.8	5.5

*Dimensions are not including the termination. For maximum overall dimensions with termination, add 0.1mm.

Note: 1. The above PCB layout reference only.
2. Recommend solder paste thickness at 0.15mm and above.

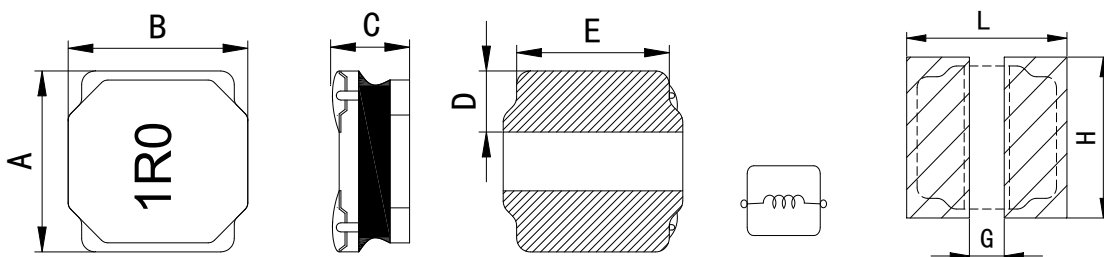

Series	*A(mm)	*B(mm)	*C(mm)	D(mm)	E(mm)
HPC5030NF	5.0±0.2	5.0±0.2	2.8±0.2	1.3±0.3	4.7±0.3

L(mm)	G(mm)	H(mm)
5.5	1.8	5.5

*Dimensions are not including the termination. For maximum overall dimensions with termination, add 0.1mm.

Note: 1. The above PCB layout refer to only.
2. Recommend solder paste thickness at 0.15mm and above.

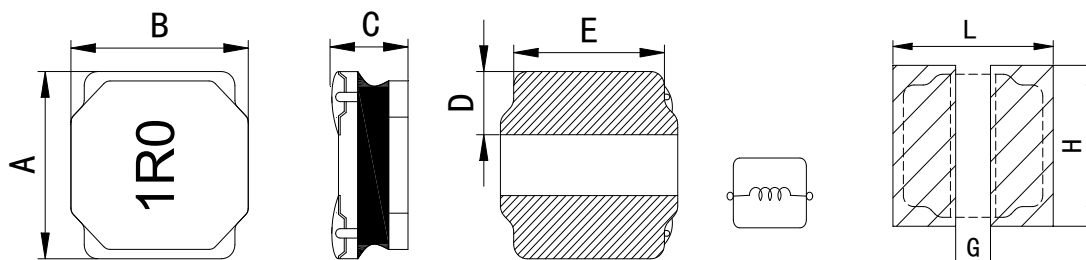

Series	Inductance	A(mm)	B(mm)	C(mm)	D(mm)	E(mm)
HPC5040NF	≤10 uH	4.95±0.2	4.95±0.2	3.9±0.2	1.3±0.3	4.2±0.2
	>10 uH			3.8±0.2		

L(mm)	G(mm)	H(mm)
5.5	1.8	5.5

*Dimensions are not including the termination. For maximum overall dimensions with termination, add 0.1mm.

Note: 1. PCB layout is referred to standard IPC-7351B
2. The above PCB layout refer to only.
3. Recommend solder paste thickness at 0.15mm and above.

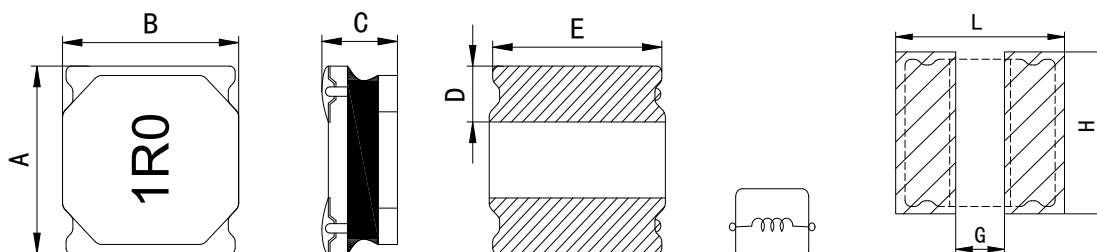

Series	*A(mm)	*B(mm)	*C(mm)	D(mm)	E(mm)
HPC6020NF	6.0±0.2	6.0±0.2	1.8±0.2	1.6±0.3	5.8±0.3

L(mm)	G(mm)	H(mm)
6.5	2.5	6.5

*Dimensions are not including the termination. For maximum overall dimensions with termination, add 0.1mm.

Note: 1. The above PCB layout refer to only.
2. Recommend solder paste thickness at 0.15mm and above.

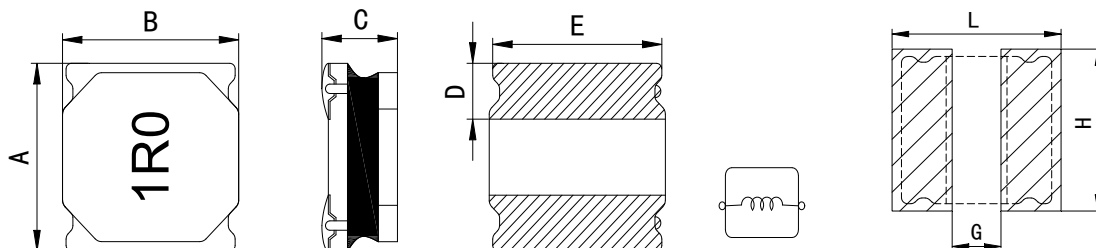

Series	*A(mm)	*B(mm)	*C(mm)	D(mm)	E(mm)
HPC6028NF	6.0±0.2	6.0±0.2	2.6±0.2	1.6±0.3	5.8±0.3

L(mm)	G(mm)	H(mm)
6.5	2.5	6.5

*Dimensions are not including the termination. For maximum overall dimensions with termination, add 0.1mm.

Note: 1. The above PCB layout refer to only.
2. Recommend solder paste thickness at 0.15mm and above.

5、Specification

Part Number	Inductance (μH) $\pm 20\%$ @ 0 A	I rms (A)		I sat (A)		DCR ($\text{m}\Omega$)	
		Typ	Max	Typ	Max	Typ	Max
HPC201608BM-R33M	0.33	3.00	2.80	2.40	2.20	33	39.6
HPC201608BM-R47M	0.47	2.80	2.60	2.05	1.90	42	50.4
HPC201608BM-R68M	0.68	2.40	2.20	1.65	1.50	56	67.2
HPC201608BM-R82M	0.82	2.20	2.00	1.55	1.40	69	82.2
HPC201608BM-1R0M	1.00	2.10	1.90	1.40	1.30	75	90
HPC201608BM-1R5M	1.50	2.00	1.80	1.20	1.10	110	132
HPC201608BM-2R2M	2.20	1.70	1.50	1.00	0.90	160	196
HPC201608BM-3R3M	3.30	1.50	1.30	0.85	0.75	230	276

Part Number	Inductance (μH) $\pm 20\%$ @ 0 A	I rms (A)		I sat (A)		DCR ($\text{m}\Omega$)	
		Typ	Max	Typ	Max	Typ	Max
HPC201610BM-R24M	0.24	5.20	4.80	4.10	3.80	20	24
HPC201610BM-R33M	0.33	4.60	4.00	3.30	3.00	29	34.8
HPC201610BM-R47M	0.47	4.00	3.70	2.90	2.70	37	45
HPC201610BM-R68M	0.68	3.60	3.30	2.50	2.30	50	60
HPC201610BM-1R0M	1.00	3.10	2.80	2.00	1.80	67	80.4
HPC201610BM-1R5M	1.50	2.50	2.10	1.60	1.40	98	118
HPC201610BM-2R2M	2.20	2.10	1.90	1.30	1.10	140	168
HPC201610BM-3R3M	3.30	1.70	1.40	1.10	0.95	210	252
HPC201610BM-4R7M	4.70	1.30	1.10	0.90	0.80	395	474
HPC201610BM-5R6M	5.60	1.10	0.90	0.85	0.77	415	498
HPC201610BM-6R8M	6.80	0.90	0.80	0.80	0.75	480	576
HPC201610BM-8R2M	8.20	0.80	0.70	0.70	0.65	630	756

Part Number	Inductance (μH) $\pm 20\%$ @ 0 A	I rms (A)		I sat (A)		DCR ($\text{m}\Omega$)	
		Typ	Max	Typ	Max	Typ	Max
HPC201612BM-R33M	0.33	4.80	4.30	3.50	3.20	25	30
HPC201612BM-R47M	0.47	4.20	3.90	3.10	2.90	35	42
HPC201612BM-R68M	0.68	3.80	3.50	2.60	2.40	45	54
HPC201612BM-1R0M	1.00	3.20	2.90	2.10	1.90	60	72
HPC201612BM-1R5M	1.50	2.60	2.20	1.70	1.50	90	108
HPC201612BM-2R2M	2.20	2.20	2.00	1.40	1.20	130	156
HPC201612BM-3R3M	3.30	1.80	1.50	1.15	1.00	190	228
HPC201612BM-4R7M	4.70	1.40	1.20	0.95	0.85	350	420
HPC201612BM-5R6M	5.60	1.20	1.00	0.90	0.80	365	438
HPC201612BM-6R8M	6.80	1.00	0.90	0.82	0.76	460	552
HPC201612BM-8R2M	8.20	0.85	0.75	0.70	0.65	610	732
HPC201612BM-100M	10.0	0.78	0.70	0.65	0.60	650	780

Part Number	Inductance (μH) $\pm 20\%$ @ 0 A	I rms(A)		I sat (A)		DCR (m Ω)	
		Typ	Max	Typ	Max	Typ	Max
HPC252008BM-R47M	0.47	2.60	2.40	2.40	2.20	46	55
HPC252008BM-R68M	0.68	2.40	2.20	2.20	2.05	61	73
HPC252008BM-R82M	0.82	2.30	2.10	2.10	2.00	77	92
HPC252008BM-1R0M	1.00	2.15	1.95	1.90	1.70	80	96
HPC252008BM-1R2M	1.20	2.10	1.90	1.85	1.65	100	120
HPC252008BM-1R5M	1.50	2.00	1.80	1.70	1.55	130	156
HPC252008BM-2R2M	2.20	1.80	1.60	1.40	1.25	175	210
HPC252008BM-3R3M	3.30	1.50	1.30	1.10	1.00	245	294
HPC252008BM-4R7M	4.70	1.25	1.05	1.00	0.90	350	420
HPC252008BM-5R6M	5.60	1.10	1.00	0.85	0.80	385	462
HPC252008BM-6R8M	6.80	1.00	0.90	0.80	0.75	530	636

Part Number	Inductance (μH) $\pm 20\%$ @ 0 A	I rms(A)		I sat (A)		DCR (m Ω)	
		Typ	Max	Typ	Max	Typ	Max
HPC252010BM-R47M	0.47	3.00	2.80	3.30	3.00	29	35
HPC252010BM-R68M	0.68	2.80	2.60	2.80	2.60	39	47
HPC252010BM-1R0M	1.00	2.60	2.40	2.50	2.30	60	72
HPC252010BM-1R5M	1.50	2.40	2.20	2.10	1.90	80	96
HPC252010BM-2R2M	2.20	2.00	1.80	1.50	1.30	110	132
HPC252010BM-3R3M	3.30	1.70	1.50	1.30	1.10	170	204
HPC252010BM-4R7M	4.70	1.40	1.20	1.20	1.10	250	300
HPC252010BM-6R8M	6.80	1.20	1.00	0.95	0.85	370	444
HPC252010BM-100M	10.0	1.00	0.80	0.75	0.65	460	552
HPC252010BM-150M	15.0	0.80	0.65	0.62	0.57	770	924

Part Number	Inductance (μH) $\pm 20\%$ @ 0 A	I rms(A)		I sat (A)		DCR (m Ω)	
		Typ	Max	Typ	Max	Typ	Max
HPC252012BM-R22Y	0.22 $\pm 30\%$	6.00	5.50	5.50	5.00	15	18
HPC252012BM-R33M	0.33	5.20	4.80	4.80	4.40	20	24
HPC252012BM-R47M	0.47	4.80	4.50	4.30	4.00	26	32
HPC252012BM-R68M	0.68	4.40	4.00	3.70	3.50	37	45
HPC252012BM-1R0M	1.00	3.60	3.30	3.00	2.80	50	60
HPC252012BM-1R2M	1.20	3.40	3.10	2.90	2.70	61	74
HPC252012BM-1R5M	1.50	3.10	2.80	2.70	2.50	70	84
HPC252012BM-2R2M	2.20	2.70	2.30	2.10	1.90	94	113
HPC252012BM-3R3M	3.30	2.20	1.90	1.70	1.50	126	152
HPC252012BM-4R7M	4.70	1.80	1.60	1.50	1.30	225	270
HPC252012BM-6R8M	6.80	1.50	1.30	1.20	1.10	310	372
HPC252012BM-100M	10.0	1.30	1.10	1.00	0.90	495	594
HPC252012BM-150M	15.0	1.00	0.90	0.80	0.70	650	780
HPC252012BM-220M	22.0	0.80	0.60	0.63	0.58	908	1090

Part Number	Inductance (μH) $\pm 20\%$ @ 0 A	I rms (A)		I sat (A)		DCR (m Ω)	
		Typ	Max	Typ	Max	Typ	Max
HPC322512BM-R33M	0.33	5.00	4.50	4.50	4.20	19	22.8
HPC322512BM-R47M	0.47	4.50	4.10	4.00	3.80	25	30
HPC322512BM-R68M	0.68	4.10	3.60	3.70	3.40	32	38
HPC322512BM-1R0M	1.00	3.50	3.20	3.00	2.80	39	47
HPC322512BM-1R5M	1.50	3.20	3.00	2.40	2.20	48	58
HPC322512BM-2R2M	2.20	2.90	2.70	2.10	1.90	72	86
HPC322512BM-3R3M	3.30	2.50	2.20	1.80	1.60	105	126
HPC322512BM-4R7M	4.70	2.20	2.00	1.50	1.30	148	177
HPC322512BM-5R6M	5.60	1.90	1.70	1.25	1.15	170	204
HPC322512BM-6R8M	6.80	1.70	1.40	1.15	1.05	200	240
HPC322512BM-8R2M	8.20	1.50	1.30	1.00	0.90	260	312
HPC322512BM-100M	10.0	1.30	1.10	0.92	0.82	350	420
HPC322512BM-150M	15.0	1.00	0.90	0.70	0.65	460	552
HPC322512BM-220M	22.0	0.80	0.70	0.60	0.55	660	792

Part Number	Inductance (μH) $\pm 20\%$ @ 0 A	I rms (A)		I sat (A)		DCR (m Ω)	
		Typ	Max	Typ	Max	Typ	Max
HPC3010BM-1R0M	1.00	3.40	3.00	2.40	2.20	56	67
HPC3010BM-1R2M	1.20	3.10	2.70	2.10	1.90	60	72
HPC3010BM-1R5M	1.50	2.80	2.50	1.90	1.70	75	90
HPC3010BM-2R2M	2.20	2.60	2.30	1.80	1.60	100	120
HPC3010BM-3R3M	3.30	2.20	1.90	1.40	1.20	130	156
HPC3010BM-4R7M	4.70	1.80	1.50	1.30	1.20	190	228
HPC3010BM-6R8M	6.80	1.50	1.30	1.10	1.00	260	312
HPC3010BM-8R2M	8.20	1.30	1.10	1.00	0.90	330	396
HPC3010BM-100M	10.0	1.10	1.00	0.80	0.70	420	504
HPC3010BM-150M	15.0	0.90	0.80	0.65	0.60	565	678
HPC3010BM-220M	22.0	0.70	0.60	0.50	0.45	760	912
HPC3010BM-330M	33.0	0.60	0.50	0.45	0.40	1270	1524

Part Number	Inductance (μH) $\pm 20\%$ @ 0 A	I rms (A)		I sat (A)		DCR ($\text{m}\Omega$)	
		Typ	Max	Typ	Max	Typ	Max
HPC3012BM-R22M	0.22	6.20	5.70	8.00	7.00	15	19
HPC3012BM-R47M	0.47	5.20	4.80	4.80	4.40	24	29
HPC3012BM-R68M	0.68	4.80	4.50	4.30	4.00	31	37
HPC3012BM-1R0M	1.00	4.20	3.80	3.60	3.30	40	48
HPC3012BM-1R2M	1.20	4.00	3.50	3.30	3.00	47	56
HPC3012BM-1R5M	1.50	3.60	3.30	3.00	2.60	52	62
HPC3012BM-2R2M	2.20	2.90	2.50	2.40	2.10	75	90
HPC3012BM-2R7M	2.70	2.60	2.30	2.10	1.90	95	114
HPC3012BM-3R3M	3.30	2.40	2.10	1.80	1.60	108	130
HPC3012BM-4R7M	4.70	2.10	1.70	1.50	1.30	140	168
HPC3012BM-5R6M	5.60	1.90	1.60	1.40	1.20	200	240
HPC3012BM-6R8M	6.80	1.70	1.40	1.30	1.10	210	252
HPC3012BM-100M	10.0	1.50	1.20	1.10	0.90	288	345
HPC3012BM-150M	15.0	1.20	1.00	0.80	0.70	400	480
HPC3012BM-220M	22.0	0.90	0.80	0.70	0.63	700	840
HPC3012BM-330M	33.0	0.80	0.70	0.61	0.56	1100	1320
HPC3012BM-470M	47.0	0.65	0.60	0.52	0.47	1500	1800

Part Number	Inductance (μH) $\pm 20\%$ @ 0 A	I rms (A)		I sat (A)		DCR ($\text{m}\Omega$)	
		Typ	Max	Typ	Max	Typ	Max
HPC3015BM-R24M	0.24	5.00	4.50	6.00	5.50	13	16
HPC3015BM-R47M	0.47	3.70	3.30	4.30	4.00	18	22
HPC3015BM-R68M	0.68	3.50	3.20	3.80	3.50	23	28
HPC3015BM-1R0M	1.00	3.00	2.70	3.00	2.70	30	36
HPC3015BM-1R5M	1.50	2.70	2.50	2.40	2.10	36	43
HPC3015BM-2R2M	2.20	2.50	2.30	2.10	1.90	60	72
HPC3015BM-3R3M	3.30	2.20	2.00	1.70	1.50	80	96
HPC3015BM-4R7M	4.70	1.90	1.70	1.50	1.30	112	134
HPC3015BM-5R6M	5.60	1.80	1.60	1.40	1.20	135	162
HPC3015BM-6R8M	6.80	1.70	1.50	1.30	1.10	172	206
HPC3015BM-100M	10.0	1.50	1.30	1.00	0.90	220	264
HPC3015BM-150M	15.0	1.20	1.00	0.85	0.72	310	372
HPC3015BM-180M	18.0	1.10	0.92	0.73	0.65	380	456
HPC3015BM-220M	22.0	1.00	0.85	0.68	0.59	450	540
HPC3015BM-330M	33.0	0.85	0.75	0.57	0.51	780	940
HPC3015BM-470M	47.0	0.70	0.60	0.46	0.41	1200	1440

Part Number	Inductance (μH) $\pm 20\%$ @ 0 A	I rms (A)		I sat (A)		DCR ($\text{m}\Omega$) $\pm 30\%$
		Typ	Max	Typ	Max	
HPC3612BM-100M	10.0	1.20	1.00	1.10	1.00	290

Part Number	Inductance (μH) $\pm 20\%$ @ 0 A	I rms (A)		I sat (A)		DCR ($\text{m}\Omega$)	
		Typ	Max	Typ	Max	Typ	Max
HPC4010BM-1R0M	1.00	3.50	3.00	2.80	2.60	60	72
HPC4010BM-2R2M	2.20	2.80	2.50	1.80	1.60	93	112
HPC4010BM-3R3M	3.30	2.50	2.30	1.40	1.30	110	132
HPC4010BM-4R7M	4.70	2.30	2.10	1.30	1.20	150	180
HPC4010BM-6R8M	6.80	1.80	1.60	1.00	0.90	200	240
HPC4010BM-100M	10.0	1.40	1.20	0.88	0.80	300	360
HPC4010BM-150M	15.0	1.20	1.00	0.65	0.60	430	516
HPC4010BM-220M	22.0	0.80	0.70	0.53	0.46	600	720

Part Number	Inductance (μH) $\pm 20\%$ @ 0 A	Test FrequenVv (Hz)	I rms (A)	I sat (A)	DCR (Ω) $\pm 20\%$
			Typ	Typ	
HPC4018BM-1R0Y	1.00 $\pm 30\%$	1V100K	3.20	4.00	0.027
HPC4018BM-1R5Y	1.50 $\pm 30\%$	1V100K	2.40	3.30	0.037
HPC4018BM-2R2M	2.20	1V100K	2.20	3.00	0.042
HPC4018BM-3R3M	3.30	1V100K	2.00	2.30	0.055
HPC4018BM-4R7M	4.70	1V100K	1.70	2.00	0.070
HPC4018BM-6R8M	6.80	1V100K	1.45	1.60	0.098
HPC4018BM-100M	10.0	1V100K	1.20	1.30	0.150
HPC4018BM-150M	15.0	1V100K	0.85	1.10	0.210
HPC4018BM-220M	22.0	1V100K	0.72	0.90	0.290
HPC4018BM-330M	33.0	1V100K	0.55	0.70	0.460
HPC4018BM-470M	47.0	1V100K	0.44	0.60	0.650
HPC4018BM-680M	68.0	1V100K	0.32	0.52	1.000

Part Number	Inductance (μH) $\pm 20\%$ @ 0 A	I rms (A)		I sat (A)		DCR ($\text{m}\Omega$)	
		Typ	Max	Typ	Max	Typ	Max
HPC4012BM-R47M	0.47	5.50	5.00	5.00	4.50	25	30
HPC4012BM-R68M	0.68	5.00	4.60	4.60	4.30	36	43
HPC4012BM-1R0M	1.00	4.40	4.20	4.00	3.60	43	52
HPC4012BM-1R2M	1.20	4.20	4.00	3.80	3.40	44	53
HPC4012BM-1R5M	1.50	3.90	3.60	3.30	3.00	52	62.4
HPC4012BM-2R2M	2.20	3.30	3.00	2.50	2.30	66	79.2
HPC4012BM-3R3M	3.30	2.80	2.60	1.90	1.70	81.6	98
HPC4012BM-4R7M	4.70	2.50	2.30	1.60	1.40	112	134
HPC4012BM-5R6M	5.60	2.10	1.90	1.40	1.30	135	162
HPC4012BM-6R8M	6.80	1.80	1.60	1.25	1.15	165	198
HPC4012BM-100M	10.0	1.40	1.20	1.00	0.90	230	276
HPC4012BM-150M	15.0	1.20	1.10	0.90	0.80	320	384
HPC4012BM-220M	22.0	1.00	0.90	0.70	0.60	470	564
HPC4012BM-330M	33.0	0.80	0.70	0.60	0.55	850	1020
HPC4012BM-470M	47.0	0.65	0.55	0.48	0.43	1100	1320

Part Number	Inductance (μH) $\pm 20\%$ @ 0 A	Test Frequency (Hz)	I rms (A)	I sat (A)	DCR ($\text{m}\Omega$)	
			Typ	Typ	Typ	Max
HPC4020BM-1R0M	1.00	1V100K	3.80	4.60	20	24
HPC4020BM-1R5M	1.50	1V100K	3.00	4.00	26	32
HPC4020BM-2R2M	2.20	1V100K	2.60	3.50	35	42
HPC4020BM-3R3M	3.30	1V100K	2.30	2.80	52	63
HPC4020BM-4R7M	4.70	1V100K	1.90	2.20	67	80
HPC4020BM-5R6M	5.60	1V100K	1.80	2.10	82	99
HPC4020BM-6R8M	6.80	1V100K	1.70	2.00	92	110
HPC4020BM-8R2M	8.20	1V100K	1.50	1.70	110	132
HPC4020BM-100M	10.0	1V100K	1.40	1.60	140	168
HPC4020BM-150M	15.0	1V100K	1.00	1.30	200	240
HPC4020BM-180M	18.0	1V100K	0.90	1.20	240	288
HPC4020BM-220M	22.0	1V100K	0.90	1.10	265	318
HPC4020BM-270M	27.0	1V100K	0.80	0.90	345	414
HPC4020BM-330M	33.0	1V100K	0.75	0.90	412	495
HPC4020BM-470M	47.0	1V100K	0.55	0.67	580	696
HPC4020BM-680M	68.0	1V100K	0.47	0.60	950	1140
HPC4020BM-101M	100	1V100K	0.35	0.50	1400	1680

Part Number	Inductance (μH) $\pm 20\%$ @ 0 A	I rms (A)	I sat (A)	DCR ($\text{m}\Omega$) $\pm 20\%$
		Typ	Typ	
HPC4030NF-R47M	0.47	6.00	7.50	8.5
HPC4030NF-R68M	0.68	4.60	6.80	10
HPC4030NF-1R0M	1.00	4.20	5.30	14
HPC4030NF-1R5M	1.50	3.40	4.90	20
HPC4030NF-2R2M	2.20	3.00	4.90	30
HPC4030NF-3R3M	3.30	2.40	3.30	40
HPC4030NF-3R6M	3.60	2.30	3.20	47
HPC4030NF-3R9M	3.90	2.20	3.10	53
HPC4030NF-4R7M	4.70	2.05	2.90	60
HPC4030NF-5R6M	5.60	1.95	2.60	65
HPC4030NF-6R8M	6.80	1.80	2.75	90
HPC4030NF-8R2M	8.20	1.60	2.10	95
HPC4030NF-100M	10.0	1.50	2.00	100
HPC4030NF-120M	12.0	1.30	1.80	135
HPC4030NF-150M	15.0	1.20	1.70	190
HPC4030NF-180M	18.0	1.10	1.50	200
HPC4030NF-220M	22.0	1.00	1.30	225
HPC4030NF-330M	33.0	0.85	1.10	330
HPC4030NF-470M	47.0	0.72	0.95	445
HPC4030NF-221M	220	0.35	0.45	2250
HPC4030NF-331M	330	0.30	0.40	3800

Part Number	Inductance (μH) $\pm 20\%$ @ 0 A	I rms (A)		I sat (A)		DCR ($\text{m}\Omega$)	
		Typ	Max	Typ	Max	Typ	Max
HPC5010NF-1R0M	1.00	3.50	3.00	2.60	2.40	54	64.8
HPC5010NF-2R2M	2.20	2.80	2.50	2.30	2.10	90	108
HPC5010NF-3R3M	3.30	2.50	2.30	1.80	1.60	108	130
HPC5010NF-4R7M	4.70	2.30	2.10	1.60	1.50	150	180
HPC5010NF-6R8M	6.80	1.90	1.70	1.40	1.30	195	234
HPC5010NF-100M	10.0	1.50	1.40	1.10	1.00	245	294
HPC5010NF-150M	15.0	1.30	1.20	0.90	0.80	400	480
HPC5010NF-220M	22.0	0.90	0.80	0.80	0.70	590	708

Part Number	Inductance (μH) $\pm 20\%$ @ 0 A	I rms (A)		I sat (A)		DCR ($\text{m}\Omega$)	
		Typ	Max	Typ	Max	Typ	Max
HPC5012NF-1R0M	1.00	4.00	3.50	4.50	4.00	57	68.4
HPC5012NF-1R5M	1.50	3.60	3.30	4.00	3.70	73	87.6
HPC5012NF-2R2M	2.20	3.30	3.00	3.40	3.20	88	105.6
HPC5012NF-3R3M	3.30	2.70	2.40	2.90	2.60	145	174
HPC5012NF-4R7M	4.70	2.30	2.10	2.40	2.20	180	216
HPC5012NF-5R6M	5.60	2.00	1.80	2.10	1.90	215	258
HPC5012NF-6R8M	6.80	1.80	1.70	1.85	1.73	255	306
HPC5012NF-8R2M	8.20	1.70	1.60	1.65	1.55	278	334
HPC5012NF-100M	10.0	1.50	1.40	1.45	1.37	400	480
HPC5012NF-150M	15.0	1.35	1.27	1.30	1.22	600	720

Part Number	Inductance (μH) $\pm 20\%$ @ 0 A	I rms (A)		I sat (A)		DCR ($\text{m}\Omega$) @25 $^{\circ}\text{C}$ $\pm 20\%$
		Typ	Max	Typ	Max	
HPC5020NF-1R0Y	1.00 $\pm 30\%$	4.10	3.60	5.00	4.50	20
HPC5020NF-1R2Y	1.20 $\pm 30\%$	3.80	3.30	4.80	4.20	20
HPC5020NF-1R5Y	1.50 $\pm 30\%$	3.50	3.00	4.50	4.00	25
HPC5020NF-2R2M	2.20	3.30	2.80	4.10	3.50	32
HPC5020NF-3R3M	3.30	2.80	2.50	3.50	3.00	43
HPC5020NF-4R7M	4.70	2.40	2.10	2.70	2.30	60
HPC5020NF-5R6M	5.60	2.10	1.80	2.40	2.00	69
HPC5020NF-6R8M	6.80	1.90	1.60	2.10	1.70	90
HPC5020NF-8R2M	8.20	1.75	1.40	1.90	1.40	98
HPC5020NF-100M	10.0	1.60	1.30	1.70	1.20	110
HPC5020NF-120M	12.0	1.40	1.10	1.40	1.00	135
HPC5020NF-150M	15.0	1.25	0.90	1.30	0.80	165
HPC5020NF-180M	18.0	1.17	0.80	1.20	0.70	190
HPC5020NF-220M	22.0	1.10	0.70	1.10	0.60	225
HPC5020NF-330M	33.0	0.80	0.60	0.80	0.50	335
HPC5020NF-470M	47.0	0.70	0.50	0.70	0.40	460

Part Number	Inductance (μH) $\pm 20\%$ @ 0 A	I rms (A)		I sat (A)		DCR (m Ω) $\pm 20\%$
		Typ	Max	Typ	Max	
HPC5030NF-R47M	0.47	8.00	7.00	10.00	9.00	10
HPC5030NF-R68M	0.68	6.50	5.50	8.00	7.00	13
HPC5030NF-1R0M	1.00	4.80	4.30	6.50	6.00	16
HPC5030NF-1R5M	1.50	4.20	3.80	6.10	5.60	20
HPC5030NF-2R2M	2.20	3.60	3.30	5.20	4.80	25
HPC5030NF-3R3M	3.30	3.20	2.90	4.20	3.90	34
HPC5030NF-4R7M	4.70	3.00	2.70	3.70	3.50	45
HPC5030NF-6R8M	6.80	2.30	2.10	3.00	2.80	62
HPC5030NF-100M	10.0	2.00	1.80	2.30	2.10	88
HPC5030NF-150M	15.0	1.60	1.40	1.80	1.60	107
HPC5030NF-220M	22.0	1.40	1.20	1.55	1.30	156
HPC5030NF-330M	33.0	1.10	1.00	1.20	1.05	210
HPC5030NF-470M	47.0	0.90	0.80	1.00	0.90	345

Part Number	Inductance (μH) $\pm 20\%$ @ 0 A	I rms (A)		I sat (A)		DCR (m Ω) $\pm 20\%$
		Typ	Typ	Typ	Typ	
HPC5040NF-R60M	0.60	8.00	8.00	11.0	11.0	8
HPC5040NF-1R0M	1.00	5.00	5.00	7.50	7.50	12
HPC5040NF-1R5M	1.50	4.50	4.50	6.50	6.50	15
HPC5040NF-1R8M	1.80	4.20	4.20	6.10	6.10	18
HPC5040NF-2R2M	2.20	3.80	3.80	5.70	5.70	21
HPC5040NF-3R3M	3.30	3.50	3.50	4.40	4.40	24
HPC5040NF-4R7M	4.70	3.20	3.20	3.90	3.90	32
HPC5040NF-6R8M	6.80	2.50	2.50	3.30	3.30	43
HPC5040NF-100M	10.0	2.20	2.20	2.52	2.52	56
HPC5040NF-150M	15.0	1.80	1.80	2.00	2.00	80
HPC5040NF-220M	22.0	1.50	1.50	1.62	1.62	123
HPC5040NF-330M	33.0	1.20	1.20	1.30	1.30	180
HPC5040NF-470M	47.0	1.00	1.00	1.10	1.10	270
HPC5040NF-680M	68.0	0.80	0.80	0.90	0.90	400
HPC5040NF-820M	82.0	0.75	0.75	0.78	0.78	490
HPC5040NF-101M	100	0.72	0.72	0.75	0.75	560

Part Number	Inductance (uH)±20% @ 0 A	I rms (A)		I sat (A)		DCR (mΩ) ±20%
		Typ	Max	Typ	Max	
HPC6020NF-1R0M	1.00	4.50	4.00	6.20	5.70	19.0
HPC6020NF-1R5M	1.50	3.80	3.30	5.50	5.00	22.5
HPC6020NF-2R0M	2.00	3.65	3.30	5.30	4.90	25.0
HPC6020NF-2R2M	2.20	3.50	3.20	5.00	4.60	29.0
HPC6020NF-3R3M	3.30	3.30	3.00	4.00	3.60	35.0
HPC6020NF-4R7M	4.70	2.80	2.50	3.00	2.70	54.0
HPC6020NF-5R6M	5.60	2.60	2.30	2.70	2.40	59.0
HPC6020NF-6R8M	6.80	2.50	2.20	2.60	2.30	78.0
HPC6020NF-8R2M	8.20	2.30	2.00	2.40	2.10	103
HPC6020NF-100M	10.0	2.10	1.90	2.10	1.90	106
HPC6020NF-150M	15.0	1.60	1.40	1.50	1.30	138
HPC6020NF-220M	22.0	1.40	1.10	1.30	1.10	204

Part Number	Inductance (uH)±20% @ 0 A	I rms (A)	I sat (A)	DCR (mΩ) ±20%
		Typ	Typ	
HPC6028NF-R82M	0.82	8.00	8.20	8.0
HPC6028NF-R90M	0.90	7.80	8.00	8.2
HPC6028NF-1R0Y	1.00±30%	5.20	5.75	10
HPC6028NF-1R2M	1.20	5.10	5.50	12
HPC6028NF-1R5Y	1.50±30%	4.95	5.30	14
HPC6028NF-2R2M	2.20	4.50	5.00	18
HPC6028NF-3R0M	3.00	3.90	4.50	22.5
HPC6028NF-3R3M	3.30	3.60	4.30	24
HPC6028NF-3R9M	3.90	3.30	3.90	28
HPC6028NF-4R7M	4.70	3.10	3.20	30
HPC6028NF-6R0M	6.00	2.80	3.00	42
HPC6028NF-6R2M	6.20	2.80	3.00	42
HPC6028NF-6R8M	6.80	2.50	2.85	47
HPC6028NF-8R2M	8.20	2.30	2.50	57
HPC6028NF-100M	10.0	2.00	2.10	65
HPC6028NF-150M	15.0	1.80	2.00	98
HPC6028NF-220M	22.0	1.50	1.60	138
HPC6028NF-330M	33.0	1.30	1.40	200
HPC6028NF-470M	47.0	1.06	1.15	280
HPC6028NF-680M	68.0	0.81	1.00	420
HPC6028NF-101M	100	0.72	0.80	605
HPC6028NF-221M	220	0.52	0.58	1320
HPC6028NF-471M	470	0.32	0.32	2250

Note:

1. All test data referenced to 25°C ambient , Ls:100KHz/1V.
2. Testing Instrument : HP4284A,CH11025,CH3302,CH1320 ,CH1320S LCR METER / Rdc:CH502BC MICRO OHMMETER.
3. Heat Rated Current (I rms) will cause the coil temperature rise approximately Δ T of 40°C
4. Saturation Current (Isat) will cause L0 to drop approximately 30%.
5. The part temperature (ambient + temp rise) should not exceed 125°C under worst case operating conditions.Circuit design,component,PCB trace size and thickness,airflow and other cooling provisions all affect the part temperature. Part temperature should be verified in the end application.
6. Special inquiries besides the above common used types can be met on your requirement.
7. Rated DC current: The lower value of I rms and Isat.

Part Number	Inductance (μH) $\pm 20\%$ @ 0 A	I rms (A)		I sat (A)		DCR ($\text{m}\Omega$) $\pm 20\%$
		Typ	Max	Typ	Max	
HPC6045NC-R36M	0.36	9.00	8.50	18.00	16.50	4.80
HPC6045NC-R47M	0.47	8.60	8.00	17.00	16.00	6.80
HPC6045NC-R82M	0.82	8.20	7.50	14.50	13.50	8.50
HPC6045NC-1R0M	1.00	8.00	7.30	13.50	12.50	10.0
HPC6045NC-1R2M	1.20	7.50	7.00	12.50	11.50	10.5
HPC6045NC-1R3M	1.30	7.50	7.00	12.50	11.50	10.5
HPC6045NC-1R5M	1.50	7.00	6.60	12.00	11.00	11.7
HPC6045NC-1R8M	1.80	6.80	6.20	11.00	10.00	12.0
HPC6045NC-2R0M	2.00	6.50	5.80	10.50	9.50	13.5
HPC6045NC-2R2M	2.20	6.00	5.30	9.50	8.55	15.0
HPC6045NC-2R3M	2.30	5.80	5.00	9.30	8.20	16.0
HPC6045NC-3R0M	3.00	5.20	4.60	8.00	7.50	20.0
HPC6045NC-3R3M	3.30	5.00	4.50	7.80	7.30	21.0
HPC6045NC-3R6M	3.60	4.90	4.30	7.40	6.90	22.5
HPC6045NC-4R7M	4.70	4.50	4.00	6.80	6.20	26.0
HPC6045NC-5R6M	5.60	4.10	3.70	6.40	5.70	31.0
HPC6045NC-6R3M	6.30	3.80	3.50	5.90	5.30	33.0
HPC6045NC-6R8M	6.80	3.60	3.30	5.70	5.15	34.0
HPC6045NC-8R2M	8.20	3.40	2.90	5.10	4.50	46.0
HPC6045NC-100M	10.0	3.20	2.60	4.60	4.20	52.0
HPC6045NC-150M	15.0	2.80	2.20	3.80	3.30	71.0
HPC6045NC-180M	18.0	2.60	2.10	3.40	2.90	80.0
HPC6045NC-220M	22.0	2.30	1.90	3.30	2.70	96.0
HPC6045NC-330M	33.0	1.80	1.50	2.50	2.10	145
HPC6045NC-470M	47.0	1.60	1.20	2.00	1.75	200
HPC6045NC-560M	56.0	1.40	1.00	1.80	1.65	230
HPC6045NC-680M	68.0	1.10	0.92	1.60	1.52	305
HPC6045NC-820M	82.0	0.98	0.88	1.50	1.40	365
HPC6045NC-101M	100	0.92	0.82	1.33	1.25	456
HPC6045NC-121M	120	0.85	0.79	1.20	1.10	500
HPC6045NC-151M	150	0.75	0.70	1.10	1.00	626
HPC6045NC-181M	180	0.68	0.60	1.00	0.90	745
HPC6045NC-221M	220	0.60	0.50	0.88	0.77	900
HPC6045NC-331M	330	0.55	0.45	0.60	0.55	1400
HPC6045NC-471M	470	0.40	0.35	0.50	0.45	2050

Note:

- All test data referenced to 25°C ambient, $L_s: 1\text{MHz}/1\text{V}$.
- Testing Instrument : HP4284A, CH11025, CH3302, CH1320, CH1320S LCR METER / Rdc: CH502BC MICRO OHMMETER.
- Heat Rated Current (I rms) will cause the coil temperature rise approximately Δt of 40°C
- Saturation Current (I sat) will cause L_0 to drop approximately 30%
- The part temperature (ambient + temp rise) should not exceed 125°C under worst case operating conditions. Circuit design, component, PCB trace size and thickness, airflow and other cooling provisions all affect the part temperature. Part temperature should be verified in the end application.
- Special inquiries besides the above common used types can be met on your requirement.
- Rated DC current: The lower value of I rms and I sat.

Part Number	Inductance (μH) $\pm 20\%$ @ 0 A	FrequeNCy	I rms (A)		I sat (A)		DCR (m Ω) $\pm 20\%$
			Typ	Max	Typ	Max	
HPC8040NC-R50M	0.50	1MHz/1V	12.00	10.00	17.00	15.00	5.5
HPC8040NC-1R0M	1.00	1MHz/1V	8.50	8.00	13.80	13.00	8.2
HPC8040NC-1R4M	1.40	1MHz/1V	8.20	7.80	11.80	11.20	10.0
HPC8040NC-1R5M	1.50	1MHz/1V	8.00	7.70	11.50	11.00	10.0
HPC8040NC-2R2M	2.20	1MHz/1V	7.40	6.90	9.80	9.20	11.5
HPC8040NC-3R3M	3.30	1MHz/1V	6.60	6.20	8.00	7.50	15.0
HPC8040NC-3R6M	3.60	1MHz/1V	6.40	6.00	7.60	7.00	15.0
HPC8040NC-4R7M	4.70	1MHz/1V	5.80	5.30	6.70	6.00	19.5
HPC8040NC-5R6M	5.60	1MHz/1V	5.40	5.20	6.20	5.80	22.0
HPC8040NC-6R8M	6.80	1MHz/1V	5.10	5.00	5.60	5.10	25.0
HPC8040NC-100M	10.0	1MHz/1V	4.60	4.20	5.00	4.30	33.0
HPC8040NC-150M	15.0	1MHz/1V	3.60	3.20	4.00	3.60	50.0
HPC8040NC-220M	22.0	1MHz/1V	2.90	2.45	3.10	2.80	73.0
HPC8040NC-330M	33.0	1MHz/1V	2.30	2.10	2.60	2.10	100
HPC8040NC-470M	47.0	1MHz/1V	2.00	1.70	2.20	1.90	135
HPC8040NC-560M	56.0	1MHz/1V	1.75	1.60	1.90	1.60	160
HPC8040NC-680M	68.0	1MHz/1V	1.65	1.50	1.75	1.50	205
HPC8040NC-820M	82.0	1MHz/1V	1.40	1.30	1.60	1.40	230
HPC8040NC-101M	100	1MHz/1V	1.20	1.10	1.45	1.20	300
HPC8040NC-121M	120	1MHz/1V	1.10	1.00	1.30	1.10	350
HPC8040NC-151M	150	1MHz/1V	0.98	0.90	1.20	1.03	410
HPC8040NC-181M	180	1MHz/1V	0.91	0.83	1.04	0.94	490
HPC8040NC-221M	220	1MHz/1V	0.85	0.76	0.99	0.90	610
HPC8040NC-331M	330	100KHz/1V	0.70	0.66	0.75	0.70	850
HPC8040NC-471M	470	100KHz/1V	0.63	0.58	0.60	0.55	1300

Note:

8. All test data referenced to 25°C.
9. Testing Instrument : HP4284A,CH11025,CH3302,CH1320 ,CH1320S LCR METER / Rdc:CH502BC MICRO OHMMETER.
10. Heat Rated Current (I rms) will cause the coil temperature rise approximately Δt of 40°C.
11. Saturation Current (I sat) will cause L0 to drop approximately 30%.
12. The part temperature (ambient + temp rise) should not exceed 125°C under worst case operating conditions. Circuit design, component, PCB trace size and thickness, airflow and other cooling provisions all affect the part temperature. Part temperature should be verified in the end application.
13. Special inquiries besides the above common used types can be met on your requirement.
14. Rated DC current: The lower value of I rms and I sat.

6、Material List

(HPC30**及以下)

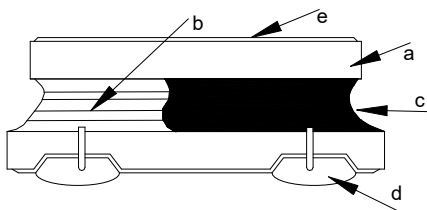

NO	Items	Materials
a	Core	Ferrite Core
b	Wire	Enameled Copper Wire
c	Glue	Epoxy with magnetic powder
d	Terminal	Ag/Ni/Sn+ Sn Solder
e	Ink	Halogen-free ketone

(HPC4010 及以上)

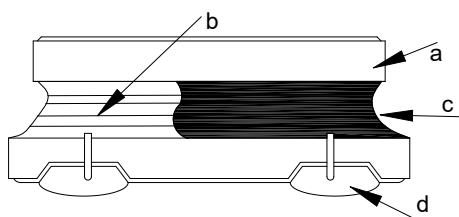

NO	Items	Materials
a	Core	Ferrite Core
b	Wire	Enameled Copper Wire
c	Glue	Epoxy with magnetic powder
d	Terminal	Ag/Ni/Sn+ Sn Solder

7、Packaging INformation

7-1、Reel Dimension(mm)

Reel: 7"

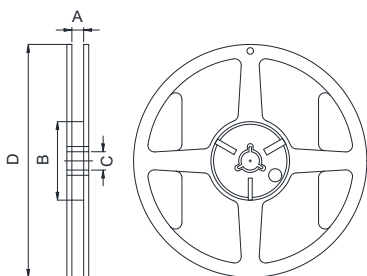

Reel: 13"

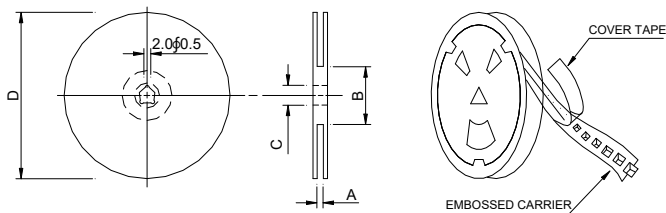

Series	Type	A(mm)	B(mm)	C(mm)	D(mm)
20**/25**/30**	7" x 8mm	8.4±1.5/-0	60.0±1.0	13+0.5/-0.2	178±2.0
40**/50**	13" x12mm	12.4+2.0/-0	100±2.0	13+0.5/-0.2	330±3.0
60**	13" x16mm	16.4+2.0/-0	100±2.0	13+0.5/-0.2	330±3.0
6045	13" x16mm	16.4+2.0/-0	100±2.0	13+0.5/-0.2	330±3.0
8040	13" x16mm	16.4+2.0/-0	100±2.0	13+0.5/-0.2	330±3.0

7-2、Tape Dimension and Packaging Quantity(mm)

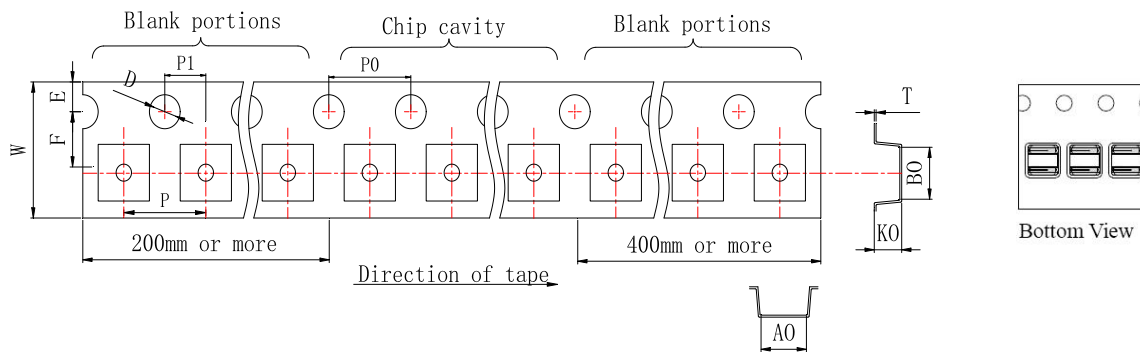

Series	Reel/PCS	B0 ±0.1	A0 ±0.1	K0 ±0.1	P ±0.1	W ±0.3	T ±0.1	E ±0.1	F ±0.1	D ±0.1	P0 ±0.1	P1 ±0.1
HPC201608	3000	2.40	2.0	1.0	4.0	8.0	0.23	1.75	3.50	1.50	4.0	2.0
HPC201610	3000	2.40	2.0	1.2	4.0	8.0	0.23	1.75	3.50	1.50	4.0	2.0
HPC201612	3000	2.40	2.0	1.4	4.0	8.0	0.23	1.75	3.50	1.50	4.0	2.0
HPC252008	3000	3.10	2.4	1.0	4.0	8.0	0.23	1.75	3.50	1.50	4.0	2.0
HPC252010	3000	3.10	2.4	1.2	4.0	8.0	0.23	1.75	3.50	1.50	4.0	2.0
HPC252012	3000	3.10	2.4	1.4	4.0	8.0	0.23	1.75	3.50	1.50	4.0	2.0
HPC322512	3000	3.60	2.9	1.4	4.0	8.0	0.23	1.75	3.50	1.50	4.0	2.0
HPC3010	3000	3.40	3.4	1.2	4.0	8.0	0.23	1.75	3.50	1.50	4.0	2.0
HPC3012	3000	3.40	3.4	1.4	4.0	8.0	0.23	1.75	3.50	1.50	4.0	2.0
HPC3015	2000	3.40	3.4	1.7	4.0	8.0	0.23	1.75	3.50	1.50	4.0	2.0

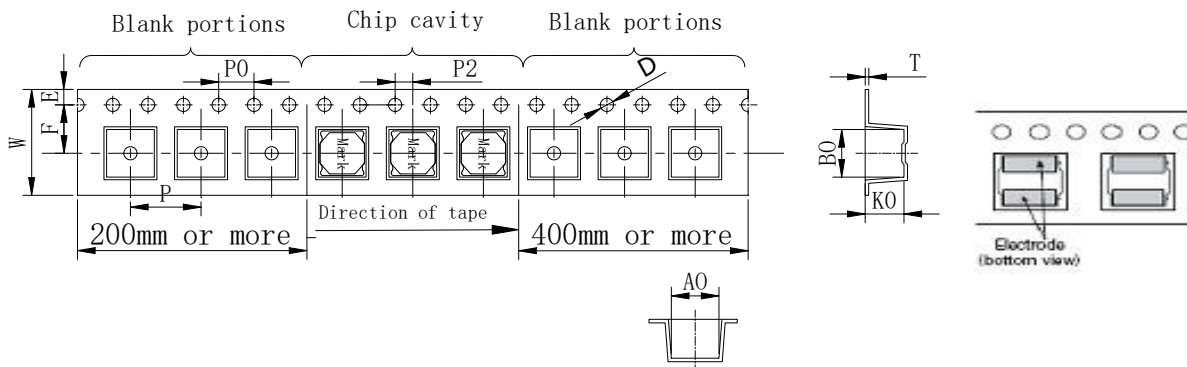

Series	Reel/PCS	B0 ±0.1	A0 ±0.1	K0 ±0.1	P ±0.1	W ±0.3	T ±0.1	E ±0.1	F ±0.1	D ±0.1	P0 ±0.1	P1 ±0.1
HPC5010	4000	5.40	5.4	1.2	8.0	12	0.35	1.75	5.50	1.50	4.0	2.0
HPC5012	4000	5.40	5.4	1.4	8.0	12	0.35	1.75	5.50	1.50	4.0	2.0
HPC5020	2500	5.40	5.4	2.2	8.0	12	0.40	1.75	5.50	1.50	4.0	2.0
HPC6020	2000	6.40	6.4	2.3	12.0	16	0.40	1.75	7.50	1.50	4.0	2.0
HPC6028	1500	6.40	6.4	3.0	12.0	16	0.40	1.75	7.50	1.50	4.0	2.0

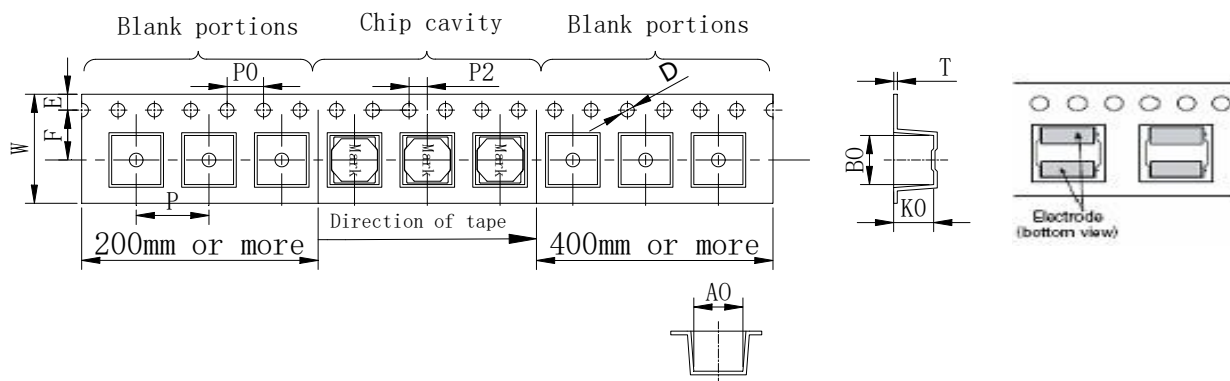

Series	Reel/PCS	B0 ±0.1	A0 ±0.1	K0 ±0.1	P ±0.1	W ±0.3	T ±0.1	E ±0.1	F ±0.1	D ±0.1	P0 ±0.1	P1 ±0.1
HPC3612	4000	4.00	4.00	1.40	8.0	12	0.35	1.75	5.5	1.50	4.0	2.0
HPC4010	4000	4.40	4.4	1.2	8.0	12	0.35	1.75	5.50	1.50	4.0	2.0
HPC4012	4000	4.40	4.4	1.4	8.0	12	0.35	1.75	5.50	1.50	4.0	2.0
HPC4018	3500	4.40	4.4	2.0	8.0	12	0.35	1.75	5.50	1.50	4.0	2.0
HPC4020	3000	4.40	4.4	2.0	8.0	12	0.35	1.75	5.50	1.50	4.0	2.0
HPC4030	2000	4.25	4.25	3.2	8.0	12	0.35	1.75	5.50	1.50	4.0	2.0
HPC5030	2000	5.40	5.4	3.2	8.0	12	0.40	1.75	5.50	1.50	4.0	2.0
HPC5040	1500	5.40	5.4	4.3	8.0	12	0.40	1.75	5.50	1.50	4.0	2.0

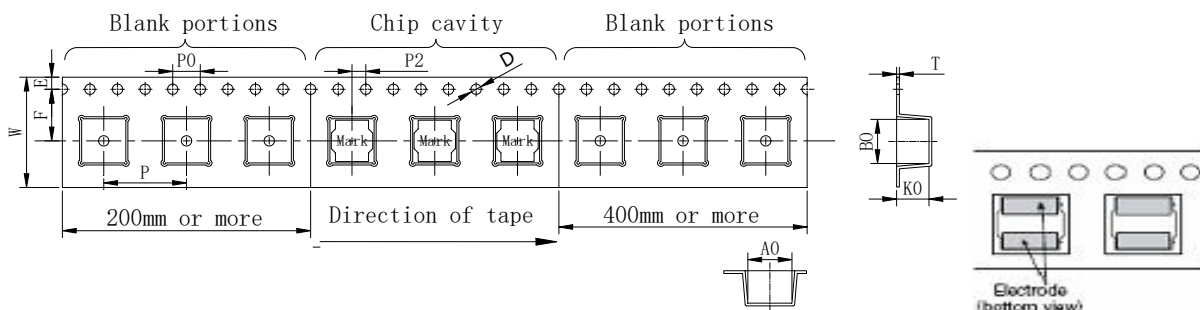

Series	Reel/PCS	B0 ±0.1	A0 ±0.1	K0 ±0.1	P ±0.1	W ±0.3	T ±0.1	E ±0.1	F ±0.1	D ±0.1	P0 ±0.1	P1 ±0.1
HPC6045	1000	6.4	6.4	4.7	12	16	0.40	1.75	7.50	1.50	4.0	2.0
HPC8040	1000	8.4	8.4	4.3	12	16	0.40	1.75	7.50	1.50	4.0	2.0

7-3. Tearing Off Force

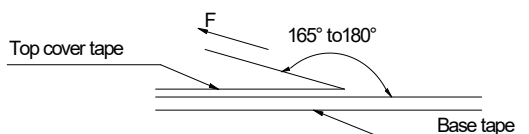

The force for tearing off cover tape is 10 to 130 grams in the arrow direction under the following conditions (referenced ANSI/EIA-481-D-2008 of 4.11 standard).

Tearing Speed mm	Room Temp. (°C)	Room Humidity (%)	Room atm (hPa)
300 ± 10%	5~35	45~85	860~1060

8、Reliability and Test Condition

Item	Performance	Test Condition															
Operating temperature	-55~+125℃(Including self - temperature rise)																
Storage temperature and Humidity range	1. -10~+40℃,50~60%RH (Product with taping) 2. -55~+125℃(on board)																
Electrical Performance Test																	
Inductance	Refer to standard electrical characteristics list.	HP4284A,CH11025,CH3302,CH1320,CH1320S LCR Meter.															
DCR		CH16502,Agilent33420A Micro-Ohm Meter.															
Saturation Current (Isat)	Approximately Δ L30%	Saturation DC Current (Isat) will cause L0 to drop Δ L(%)															
Heat Rated Current (Irms)	Approximately Δ T40℃	Heat Rated Current (Irms) will cause the coil temperature rise Δ T(℃). 1.Applied the allowed DC current 2.Temperature measured by digital surface thermometer															
Reliability Test																	
High Temperature Exposure(Storage) AEC-Q200	Appearance: No damage. Inductance: with in \pm 10% of initial value Q: Shall not exceed the specification value. RDC: within \pm 15% of initial value and shall not exceed the specification value	Preconditioning: Run through IR reflow for 3 times.(IPC/JEDEC J-STD-020E Classification Reflow Profiles Temperature: 125 \pm 2℃ (Inductor) Duration : 1000hrs Min. Measured at room temperature after placing for 24 \pm 2 hrs															
Temperature Cycling AEC-Q200		Preconditioning: Run through IR reflow for 3 times.(IPC/JEDEC J-STD-020E Classification Reflow Profiles Condition for 1 cycle Step1: -55 \pm 2℃ 30min Min.(Inductor) Step2: 125 \pm 2℃ transition time 1min MAX. Step3: 125 \pm 2℃ 30min Min. Step4: Low temp. transition time 1min MAX. Number of cycles: 1000 Measured at room temperature after placing for 24 \pm 2 hrs															
Biased Humidity (AEC-Q200)		Preconditioning: Run through IR reflow for 3 times.(IPC/JEDEC J-STD-020E Classification Reflow Profiles Humidity : 85 \pm 3% R.H, Temperature: 85℃ \pm 2℃ Duration : 1000hrs Min Measured at room temperature after placing for24 \pm 4hrs															
High Temperature Operational Life (AEC-Q200)		Preconditioning: Run through IR reflow for 3 times.(IPC/JEDEC J-STD-020E Classification Reflow Profiles Temperature: 125 \pm 2℃ (Inductor) Duration : 1000hrs Min. with 100% rated current. Measured at room temperature after placing for24 \pm 2hrs															
External Visual	Appearance: No damage.	Inspect device construction, marking and workmanship. Electrical Test not required.															
Physical Dimension	According to the product specification size measurement	According to the product specification size measurement															
Resistance to Solvents	Appearance: No damage.	Add aqueous wash chemical - OKEM clean or equivalent.															
Mechanical Shock	Appearance: No damage. Inductance: with in \pm 10% of initial value Q: Shall not exceed the specification value. RDC: within \pm 15% of initial value and shall not exceed the specification value	<table border="1"> <thead> <tr> <th>Type</th> <th>Peak value (g's)</th> <th>Normal duration (D) (ms)</th> <th>Wave form</th> <th>Velocity change (Vi)ft/sec</th> </tr> </thead> <tbody> <tr> <td>SMD</td> <td>100</td> <td>6</td> <td>Half-sine</td> <td>12.3</td> </tr> <tr> <td>Lead</td> <td>100</td> <td>6</td> <td>Half-sine</td> <td>12.3</td> </tr> </tbody> </table> shocks in each direction along 3 perpendicular axes.(18 shocks).	Type	Peak value (g's)	Normal duration (D) (ms)	Wave form	Velocity change (Vi)ft/sec	SMD	100	6	Half-sine	12.3	Lead	100	6	Half-sine	12.3
Type	Peak value (g's)	Normal duration (D) (ms)	Wave form	Velocity change (Vi)ft/sec													
SMD	100	6	Half-sine	12.3													
Lead	100	6	Half-sine	12.3													

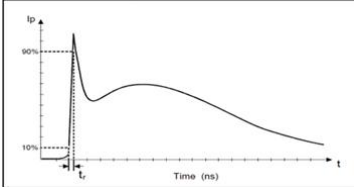
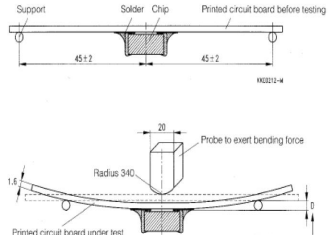
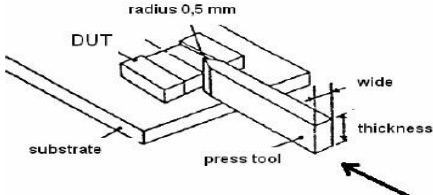
Item	Performance	Test Condition						
Vibration		IPC/JEDEC J-STD-020D Classification Reflow Profiles Oscillation Frequency: 10~2K~10Hz for 20 minute Equipment: Vibration checker Total Amplitude: 1.52mm±10% Testing Time : 12 hours(20 minutes, 12 cycles each of 3 orientations).						
Resistance to Soldering Heat	Appearance: No damage. Inductance: within ± 10% of initial value Q: Shall not exceed the specification value. RDC: within ± 15% of initial value and shall not exceed the specification value Resistance to Soldering Heat	Test condition:(MIL-STD-202 Condition B) Number of heat cycles:1 <table border="1" data-bbox="967 421 1337 524"> <thead> <tr> <th>Temperature(°C)</th> <th>Time(s)</th> <th>Temperature ramp/immersion and emersion rate</th> </tr> </thead> <tbody> <tr> <td>260±5 (solder temp)</td> <td>10±1</td> <td>25mm/s ± 6mm/s</td> </tr> </tbody> </table> Depth: completely cover the termination	Temperature(°C)	Time(s)	Temperature ramp/immersion and emersion rate	260±5 (solder temp)	10±1	25mm/s ± 6mm/s
Temperature(°C)	Time(s)	Temperature ramp/immersion and emersion rate						
260±5 (solder temp)	10±1	25mm/s ± 6mm/s						
Thermal shock (AEC-Q200)		Preconditioning: Run through IR reflow for 3 times.(IPC/JEDEC J-STD-020E Classification Reflow Profiles Condition for 1 cycle Step1: -55±2°C 15±1min(Inductor) Step2: 125±2°C within 20Sec. Step3: 125±2°C 15±1min Number of cycles: 300 Measured at room tempraturc after placing fo24±2hrs						
ESD	Appearance: No damage.	 <p>Direct Contact and Air Discharge PASSIVE COMPONENT HBM ESD Discharge Waveform to a Coaxial Target Test method: AEC-Q200-002 Test mode: Contact Discharge Discharge level: 4 KV (Level: 2)</p>						
Solderability	More than 95% of the terminal electrode should be covered with solder.	a. Method B1, 4 hrs @155°C dry heat @255°C±5°C Test time: 5 +0/-0.5 seconds. b. Method D category 3. (steam aging 8hours ± 15 min)@ 260°C±5°C Test time: 30 +0/-0.5 seconds.						
Electrical Characterization	Refer Specification for Approval	Summary to show Min, Max, Mean and Standard deviation .						
Flammability	Electrical Test not required.	V-0 or V-1 are acceptable.						
Board Flex	Appearance: No damage	Preconditioning: Run through IR reflow for 3 times.(IPC/JEDEC J-STD-020E Classification Reflow Profiles Place the 100mm X 40mm board into a fixture similar to the one shown in below Figure with the component facing down. The apparatus shall consist of mechanical means to apply a force which will bend the board (D) x = 2 mm minimum. The duration of the applied forces shall be 60 (+ 5) sec. The force is to be applied only once to the board. 						
Terminal Strength(SMD)	Appearance: No damage	Preconditioning: Run through IR reflow for 3 times.(IPC/JEDEC J-STD-020E Classification Reflow Profiles With the component mounted on a PCB with the device to be tested, apply a 17.7 N (1.8 Kg) force to the side of a device being tested. This force shall be applied for 60 +1 seconds. Also the force shall be applied gradually as not to apply a shock to the component being tested. 						

Note : When there are questions concerning measurement result : measurement shall be made after 48 ± 2 hours of recovery under the standard condition.

9、Soldering Specifications

(1) Soldering

Mildly activated rosin fluxes are preferred. TAI-TECH terminations are suitable for re-flow soldering systems. If hand soldering cannot be avoided, the preferred technique is the utilization of hot air soldering tools.

(2) Soldering Reflow:

Recommended temperature profiles for lead free re-flow soldering in Figure 1. Table 1.1&1.2 (J-STD-020E)

(3) Iron Reflow:

Products attachment with a soldering iron is discouraged due to the inherent process control limitations. In the event that a soldering iron must be employed the following precautions are recommended.(Fig. 2)

- Preheat circuit and products to 150°C
- Never contact the ceramic with the iron tip
- Use a 20 watt soldering iron with tip diameter of 1.0mm
- 355°C tip temperature (max)
- 1.0mm tip diameter (max)
- Limit soldering time to 4~5sec.

Fig.1 Soldering Reflow

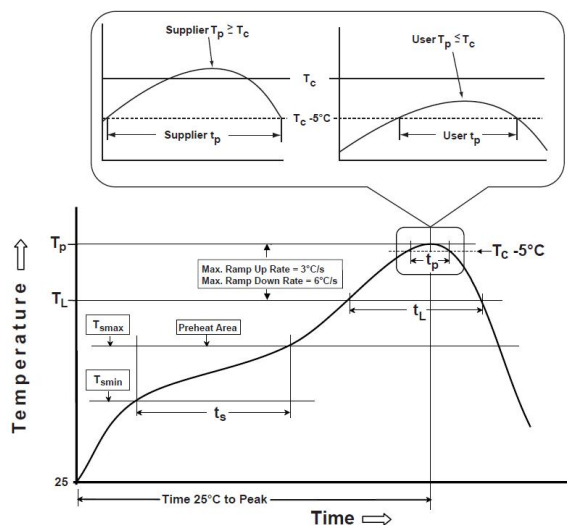

Reflow times: 3 times max

Fig.2 Iron soldering temperature profiles

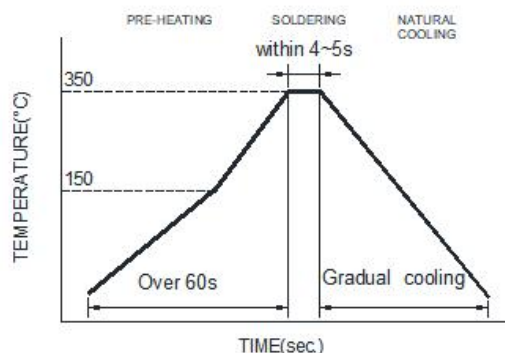

Iron Soldering times: 1 times max.

Soldering iron Method : 350± 5°C max

Table (1.1): Reflow Profiles

Profile Type:	Pb-Free Assembly
Preheat	
-Temperature Min(T_{smin})	150°C
-Temperature Max(T_{smax})	200°C
-Time(t_s)from(T_{smin} to T_{smax})	60-120seconds
Ramp-up rate(T_L to T_p)	3°C/second max.
Liquidus temperature(T_L)	217°C
Time(t_L)maintained above T_L	60-150 seconds
Classification temperature(T_c)	See Table (1.2)
Time(t_p) at $T_c - 5^\circ\text{C}$ (T_p should be equal to or less than T_c .)	* < 30 seconds
Ramp-down rate(T_p to T_L)	6°C /second max.
Time 25°C to peak temperature	8 minutes max.

T_p : maximum peak package body temperature, T_c : the classification temperature.

For user (customer) T_p should be equal to or less than T_c .

* Tolerance for peak profile temperature (T_p) is defined as a supplier minimum and a user maximum.

Table (1.2) Package Thickness/Volume and Classification Temperature (T_c)

	Package Thickness	Volume mm ³ <350	Volume mm ³ 350-2000	Volume mm ³ >2000
PB-Free Assembly	<1.6mm	260°C	260°C	260°C
	1.6-2.5mm	260°C	250°C	245°C
	≥2.5mm	250°C	245°C	245°C

Reflow is referred to standard IPC/JEDEC J-STD-020E.

10、Notes

- (1) When there are questions concerning measurement result : measurement shall be made after 48 ± 2 hours of recovery under the standard condition
- (2) This power choke coil itself does not have any protective function in abnormal condition such as overload, short-circuit and open-circuit conditions, etc. Therefore, it shall be confirmed as the end product that there is no risk of smoking, fire, dielectric withstand voltage, insulation resistance, etc. in abnormal conditions to provide protective devices and/or protection circuit in the end product.
- (3) When this power choke coil was used in a similar or new product to the original one, sometimes it might not be able to satisfy the specifications due to different condition of use.
- (4) Dielectric withstanding test with higher voltage than specific value will damage insulating material and shorten its life.
- (5) This power choke coil must not be used in wet condition by water, coffee or any liquid because insulation strength becomes very low in this condition.
- (6) Please consult our company to confirm the reliability of the process required to wash or use or exposure to a chemical solvent used in this product. PCB washing tested to MIL-STD-202 Method, and dry it off immediately.
- (7) The rated current as listed is either the saturation current or the heating current depending on which value is lower.
- (8) If this power choke is dipped in the cleaning agent, such as toluene, xylene, ketone, and ether system, there is a possibility that the performance decreases greatly, and marking disappears.
- (9) The high power ultrasonic washing may damage the choke body.
- (10) Before use, the user should determine whether this product is suitable for their own design. Our company only guarantees that the product meets the requirements of this specification.

Application Notice

· Storage Conditions

To maintain the solderability of terminal electrodes:

1. TAI-TECH products meet IPC/JEDEC J-STD-020E standard-MSL, level 1.
2. Temperature and humidity conditions: Less than 40°C and 60% RH.
3. Recommended products should be used within 12 months from the time of delivery.
4. The packaging material should be kept where no chlorine or sulfur exists in the air.

· Transportation

1. Products should be handled with care to avoid damage or contamination from perspiration and skin oils.
2. The use of tweezers or vacuum pick up is strongly recommended for individual components.
3. Bulk handling should ensure that abrasion and mechanical shock are minimized.

10、Typical Performance Curves

HPC201608BM

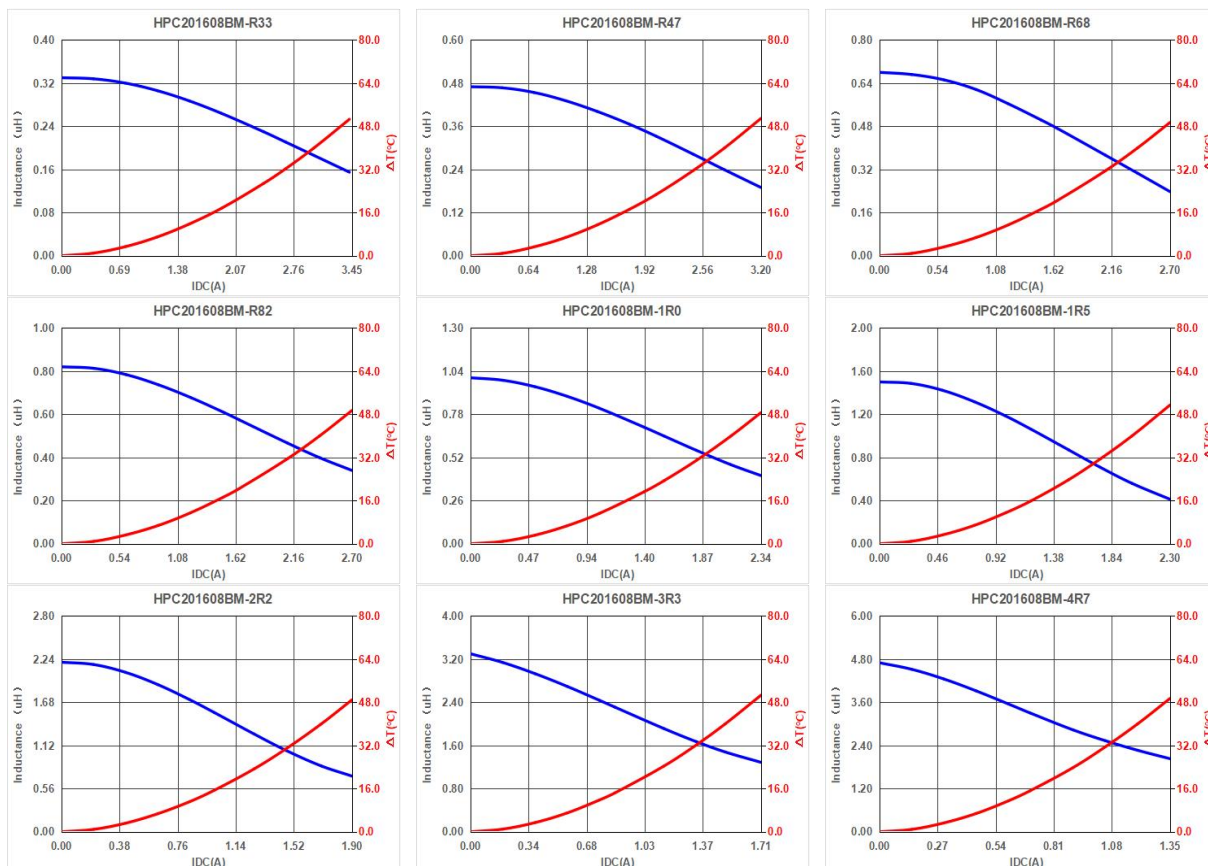

HPC201610BM

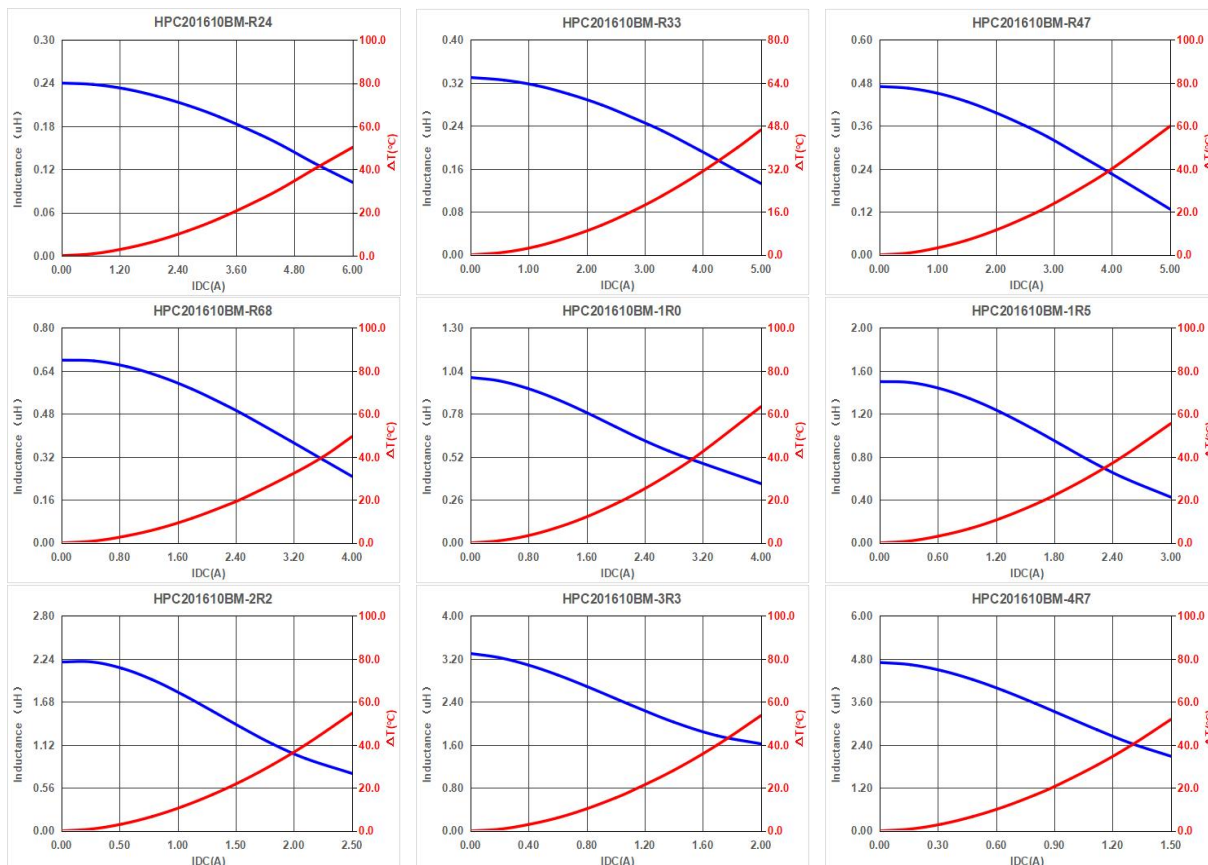

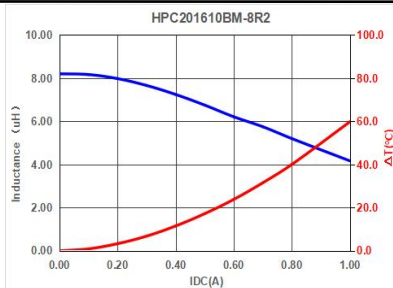
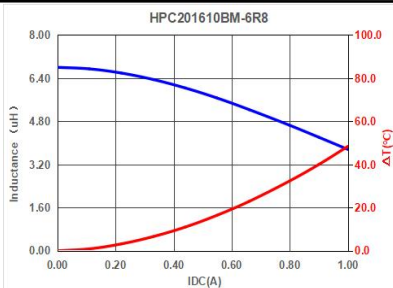
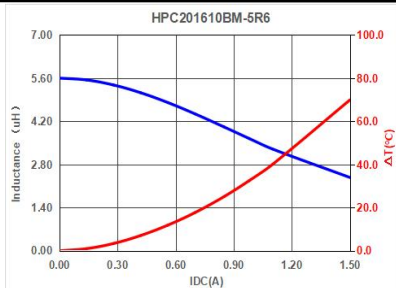

HPC201612BM

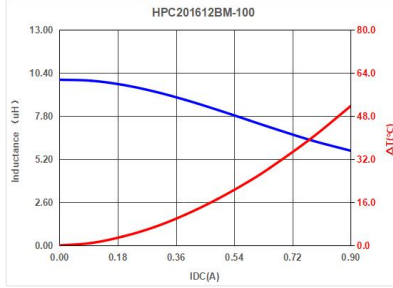
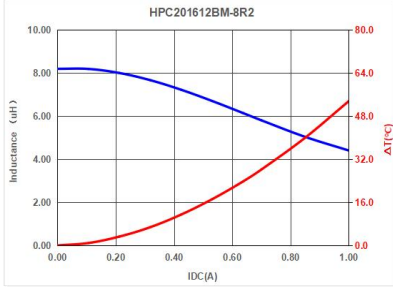
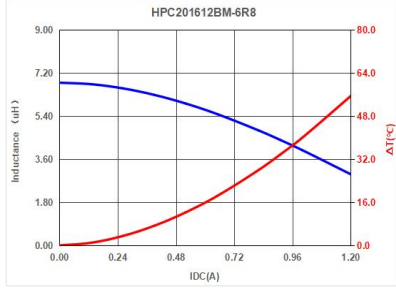
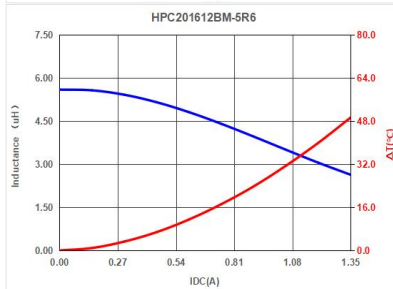
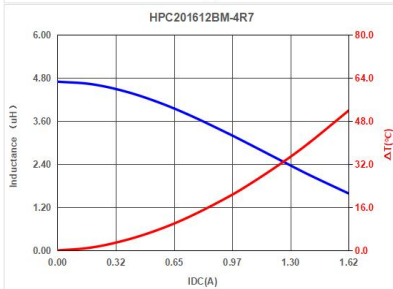
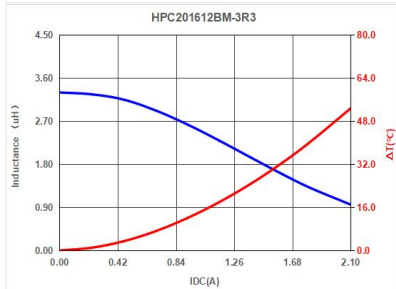
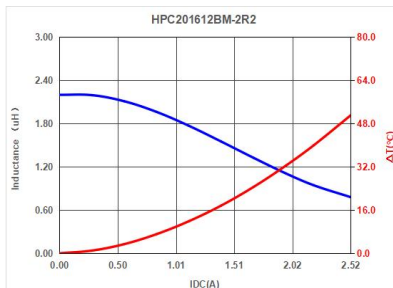
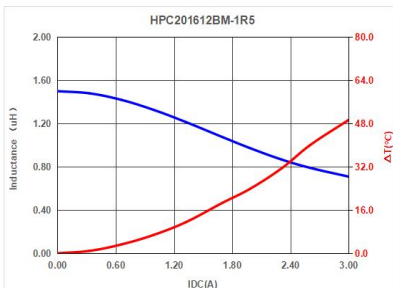
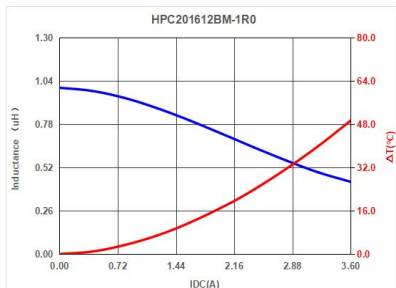
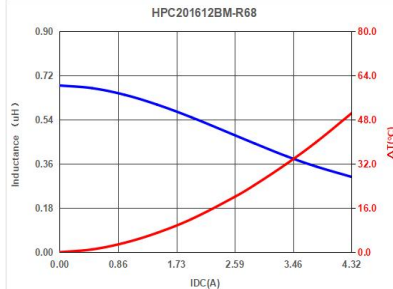
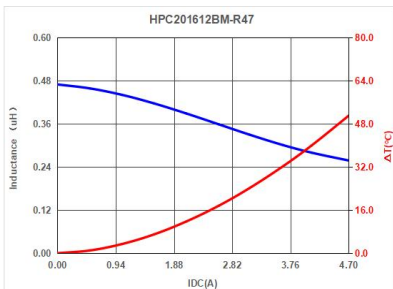
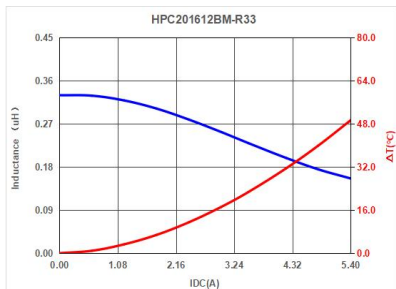

HPC252008BM

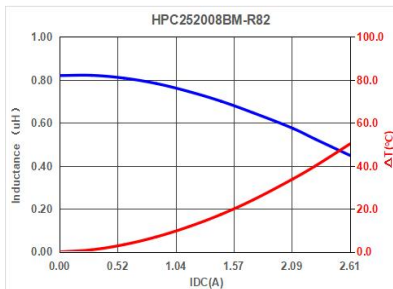
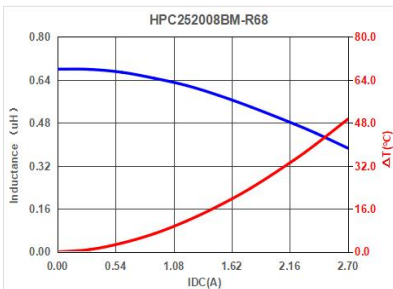
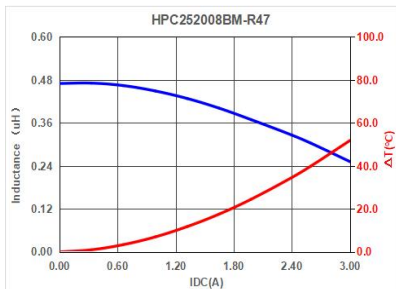

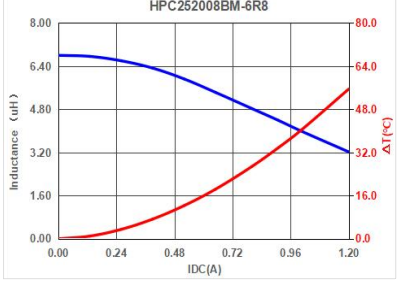
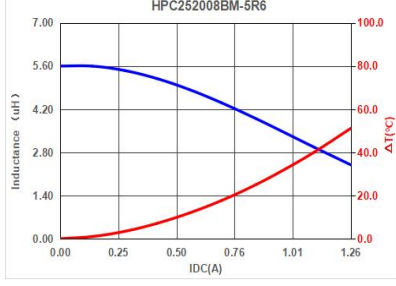
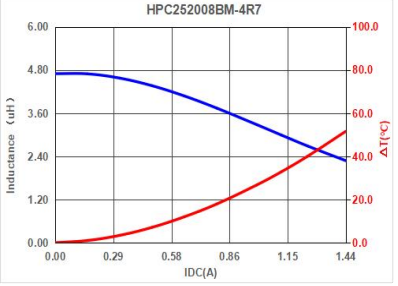
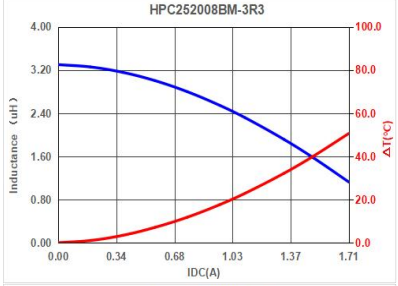
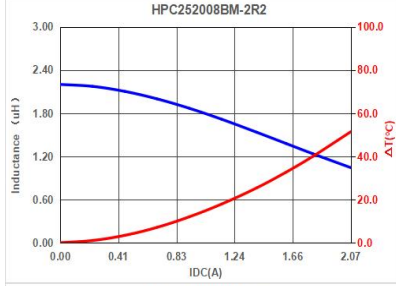
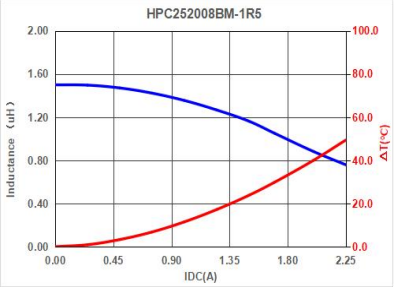
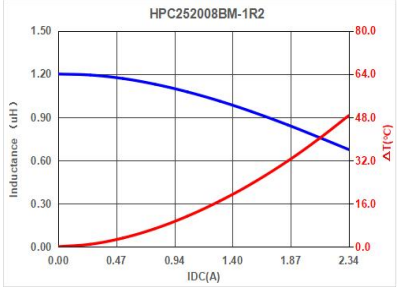
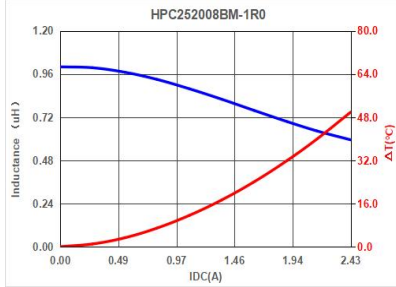

HPC252010BM

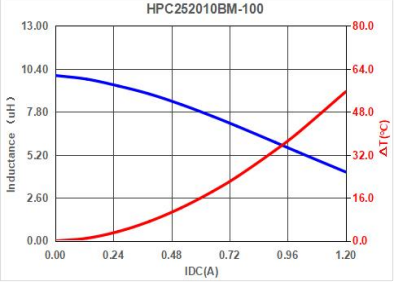
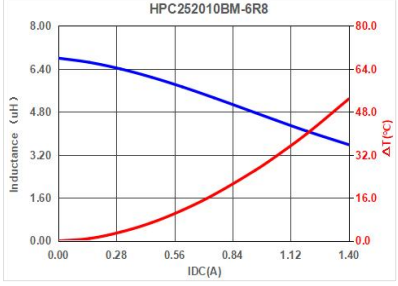
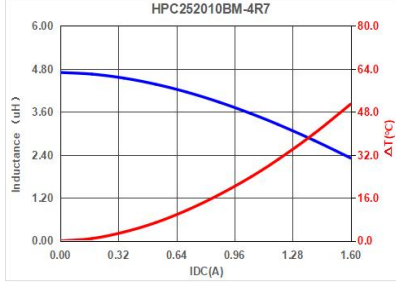
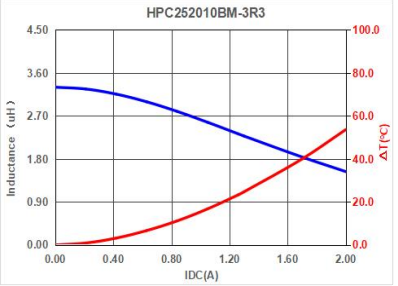
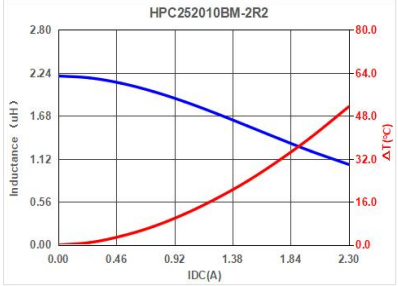
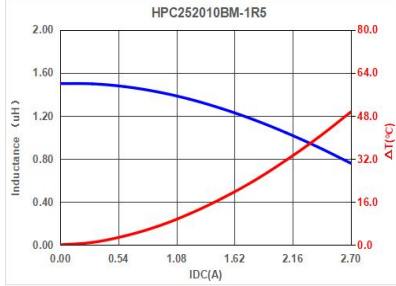
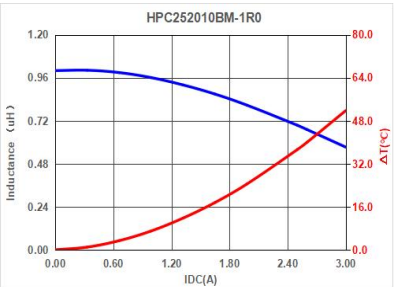
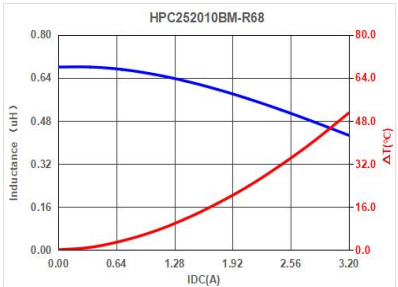
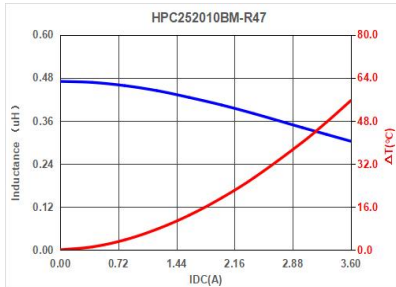

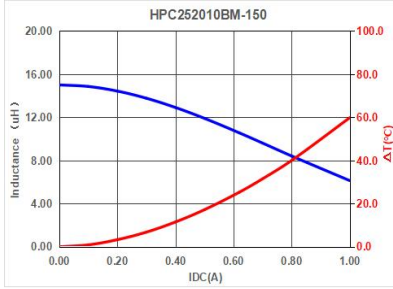

HPC252012BM

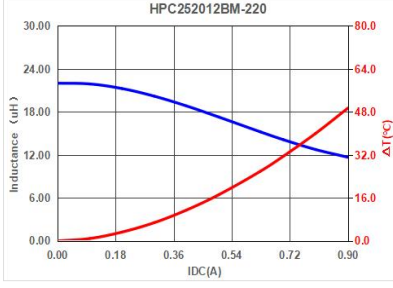
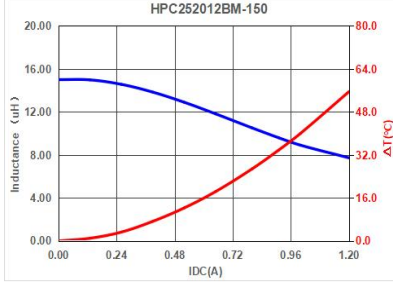
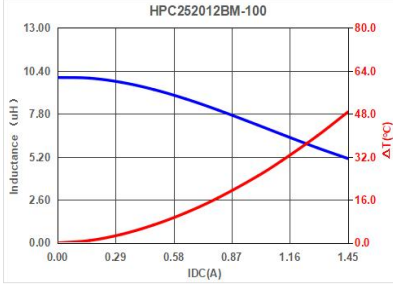
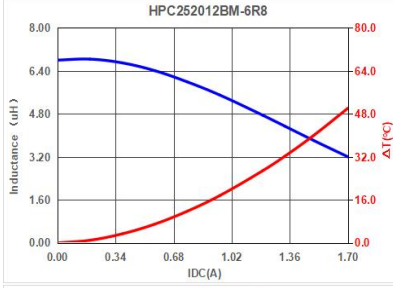
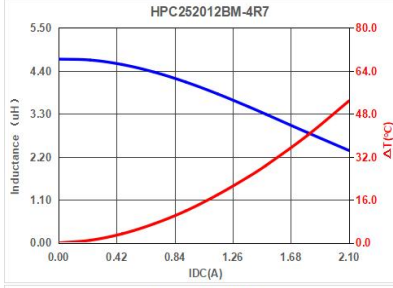
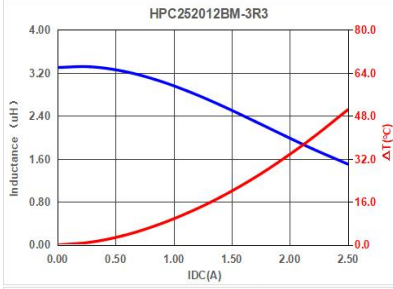
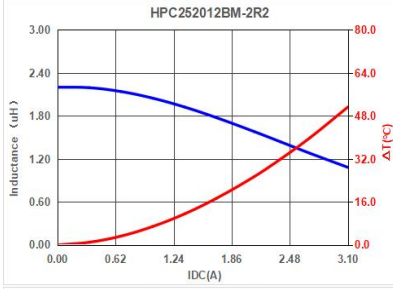
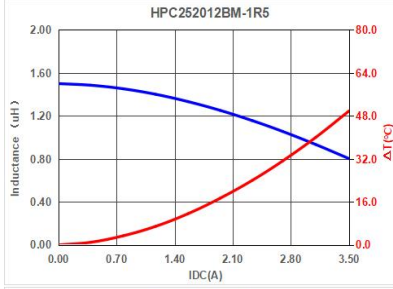
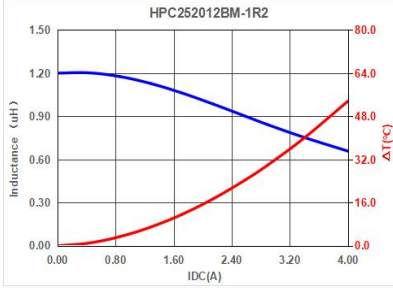
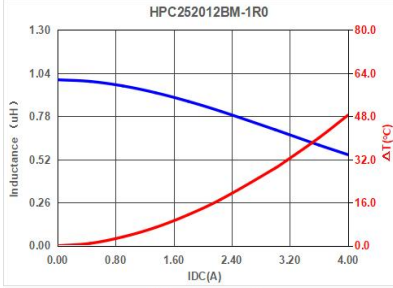
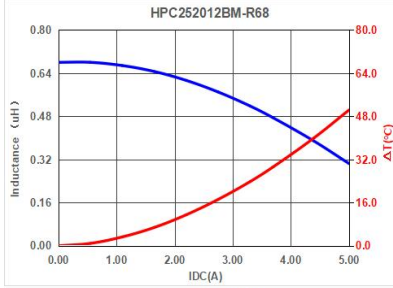
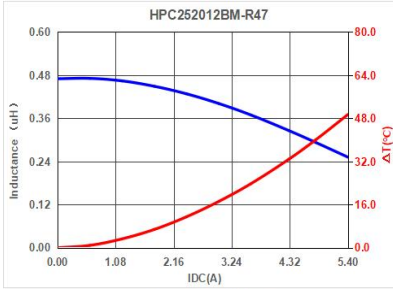
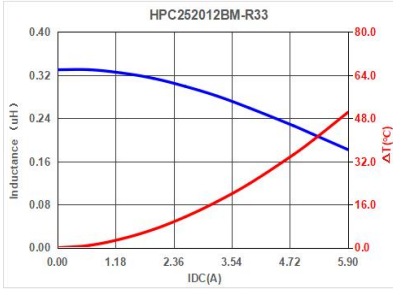
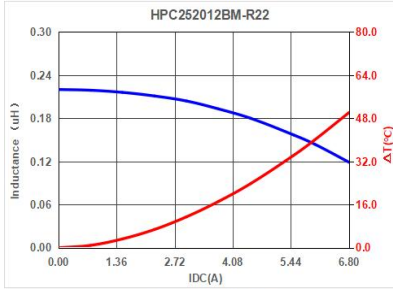

HPC322512BM

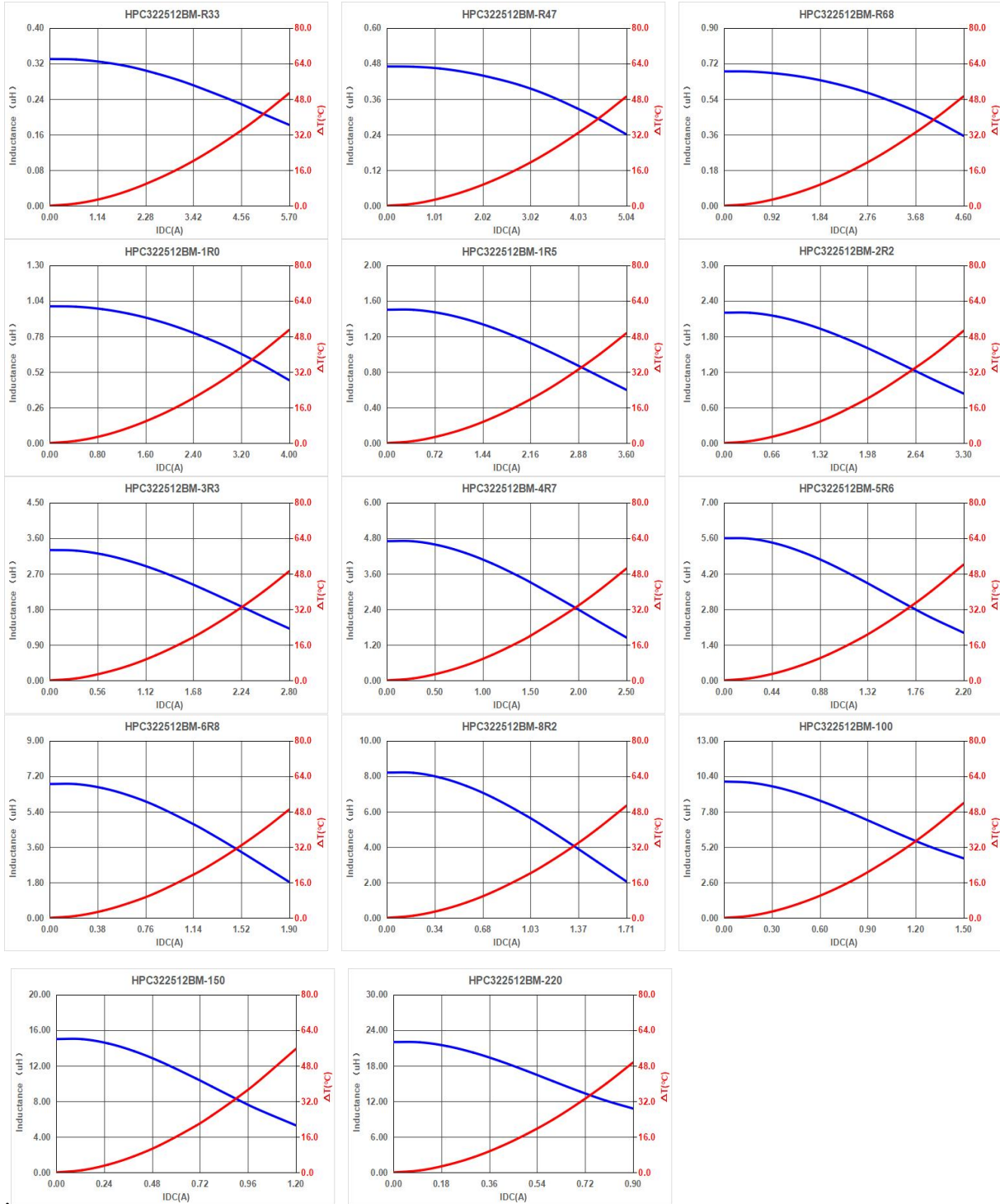

HPC3010BM

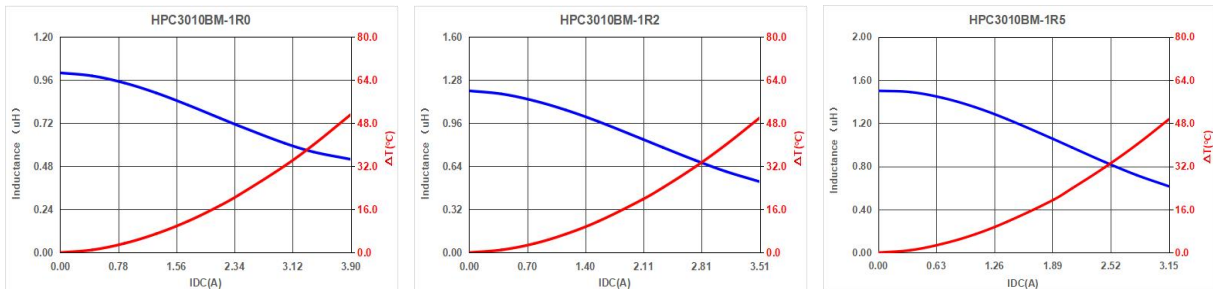

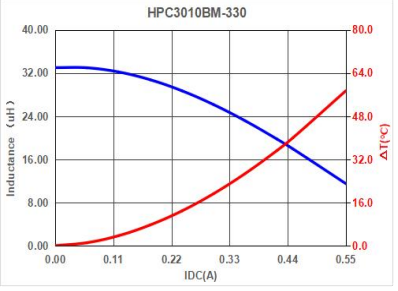
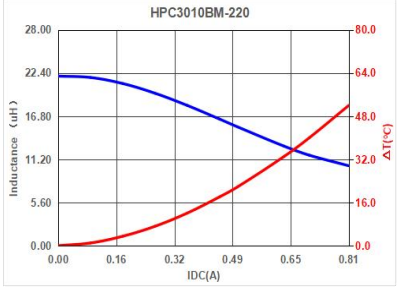
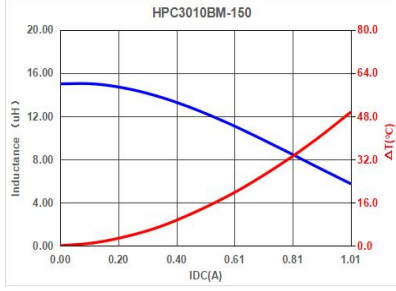
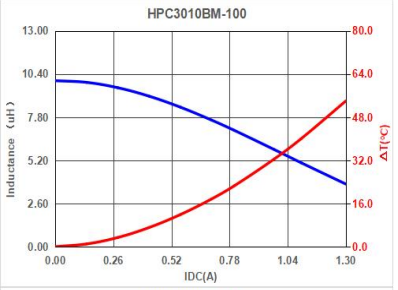
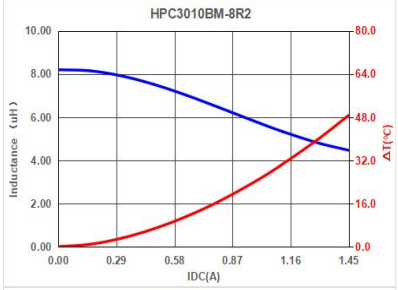
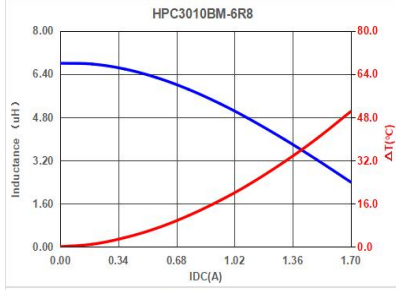
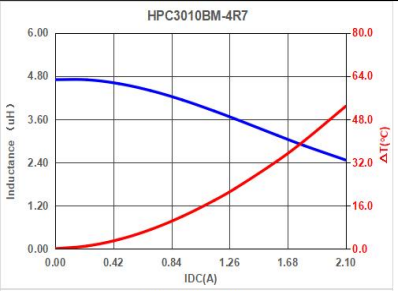
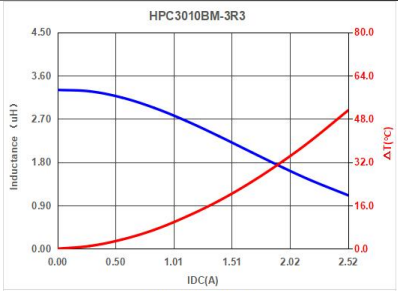
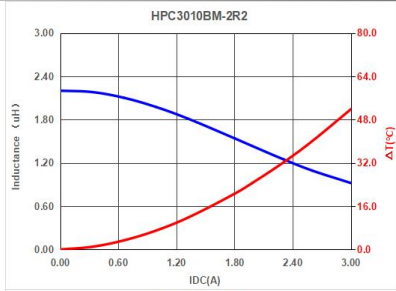

HPC3012BM

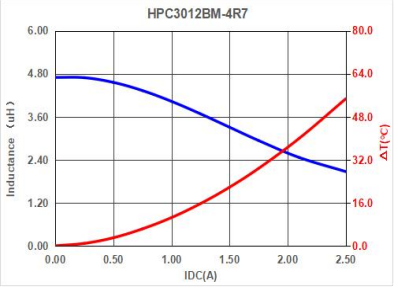
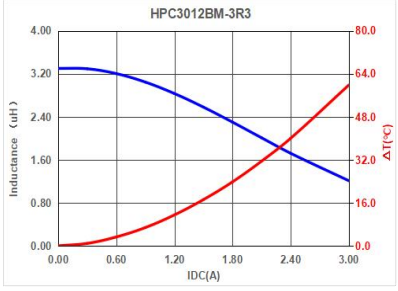
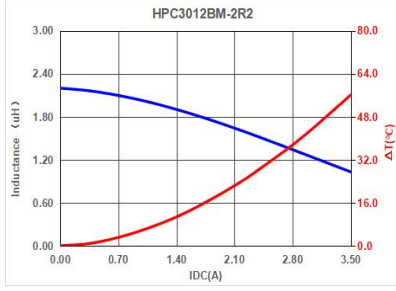
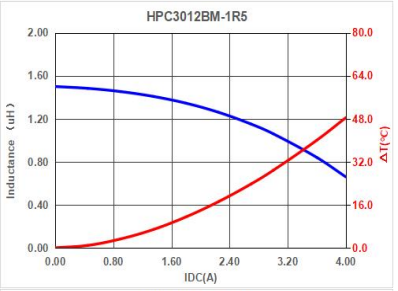
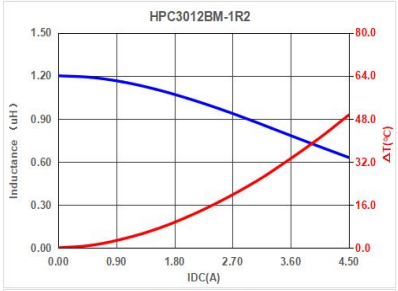
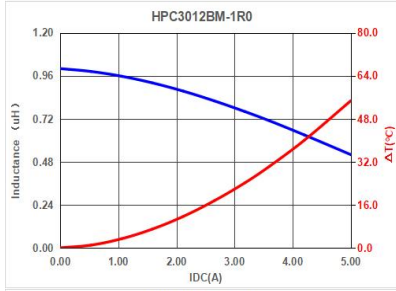
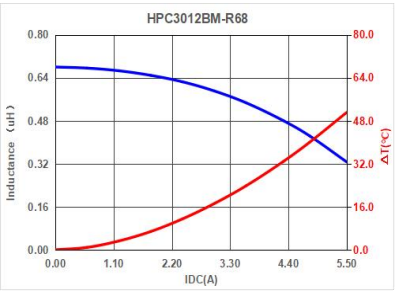
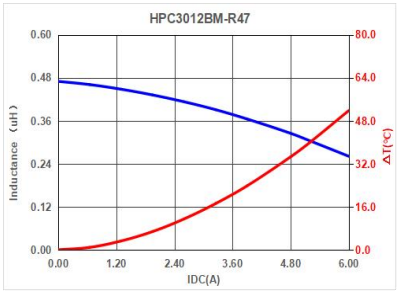
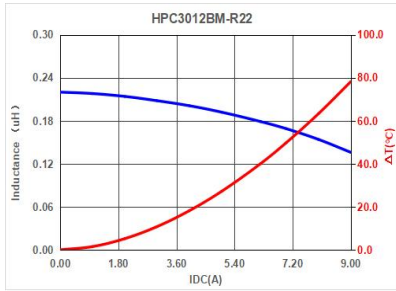

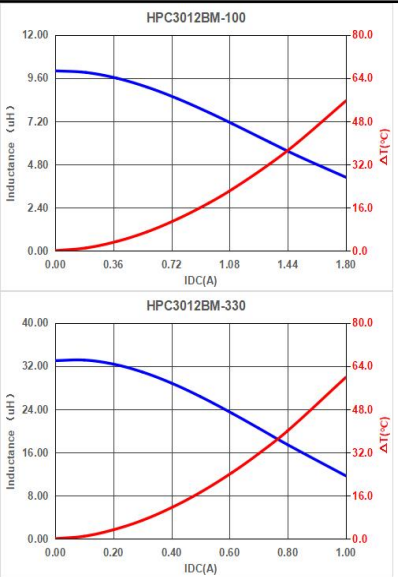
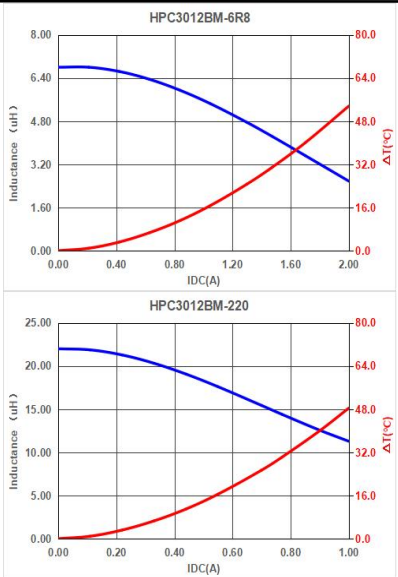
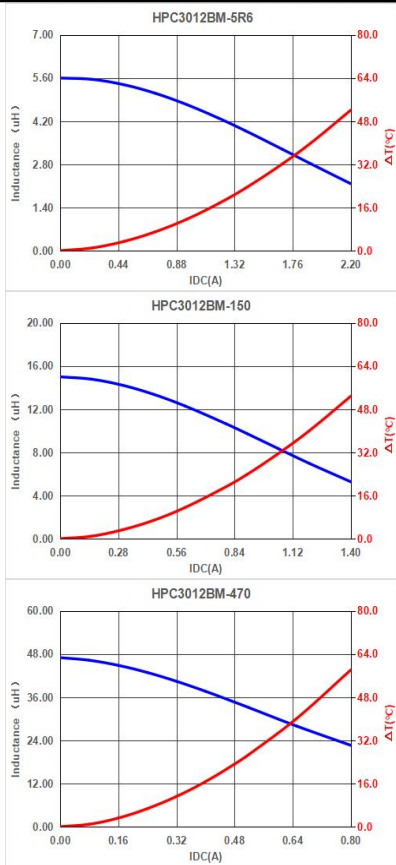

HPC3015BM

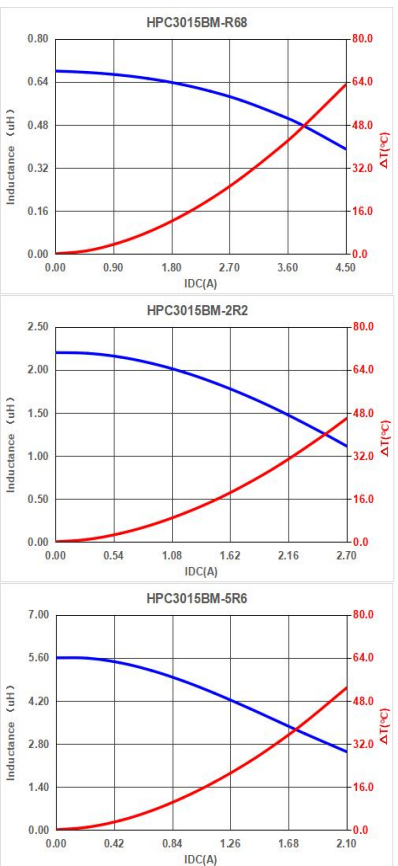
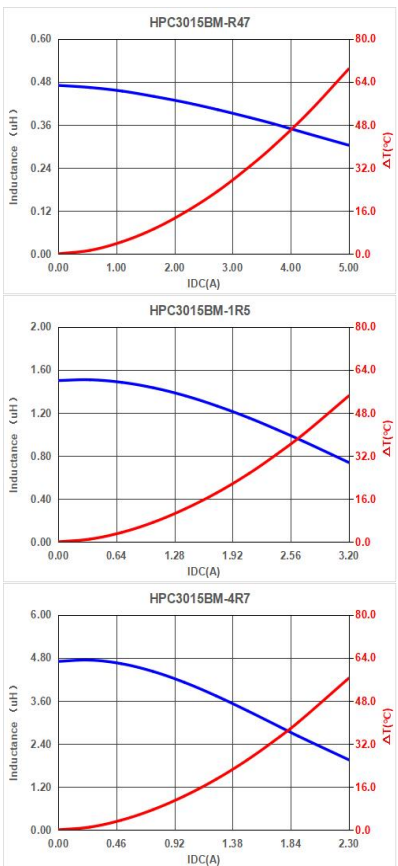
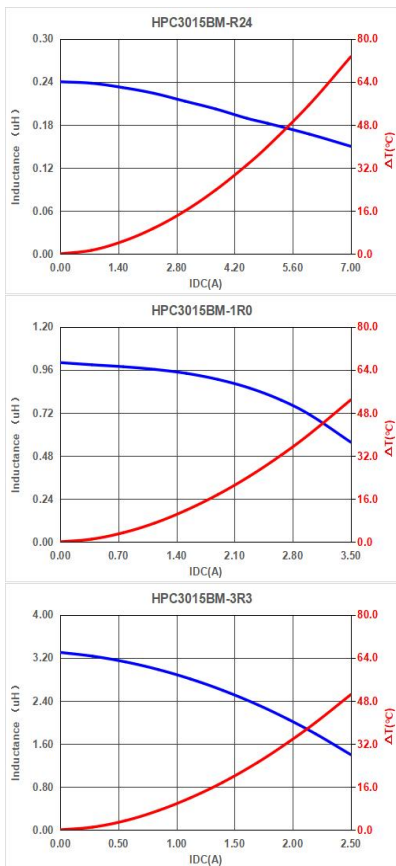

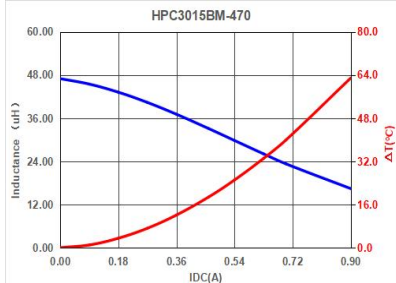
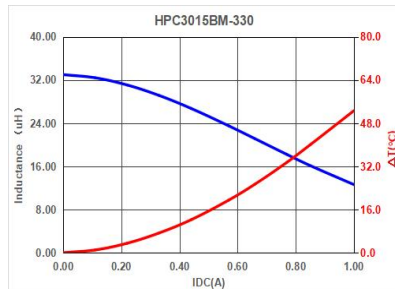
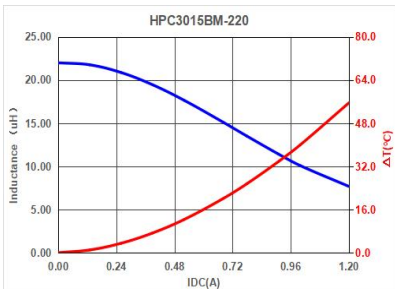
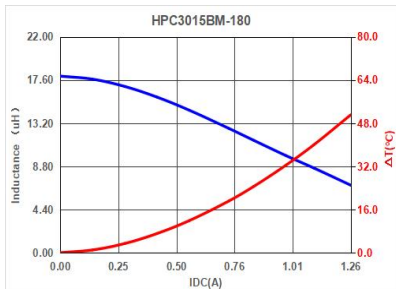
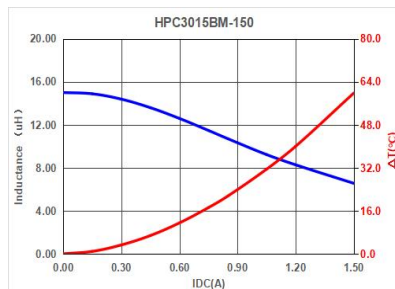
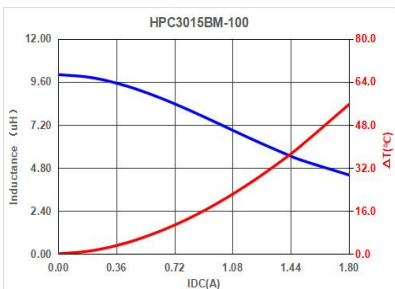
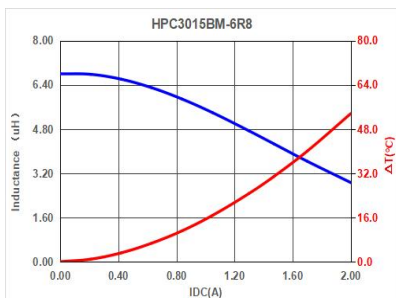

HPC3612BM

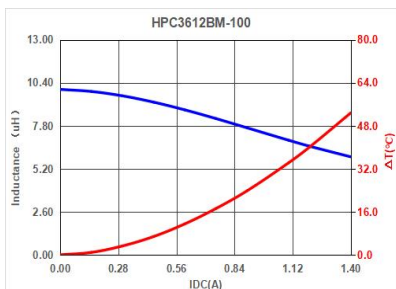

HPC4010BM

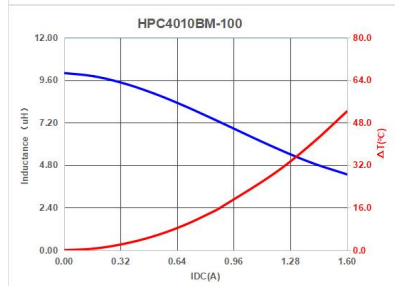
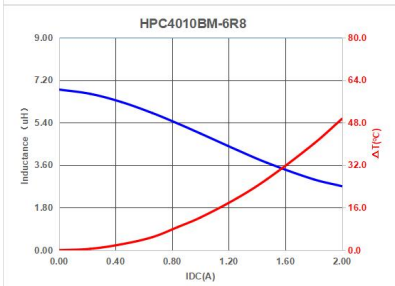
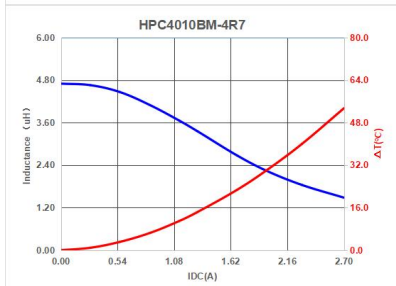
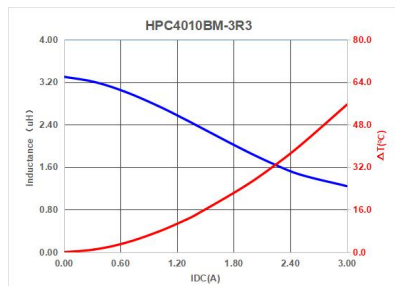
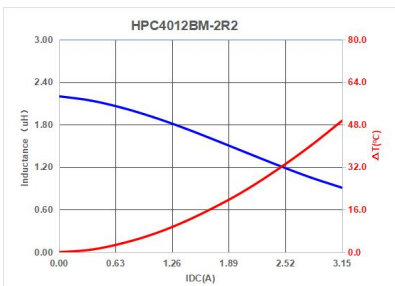
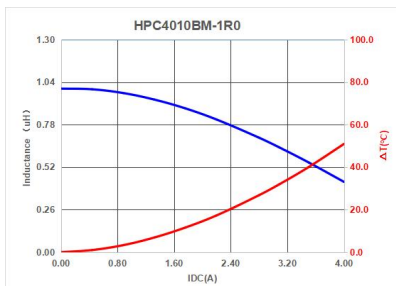

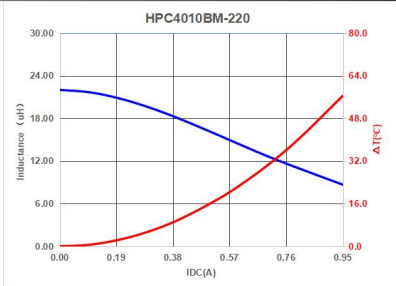
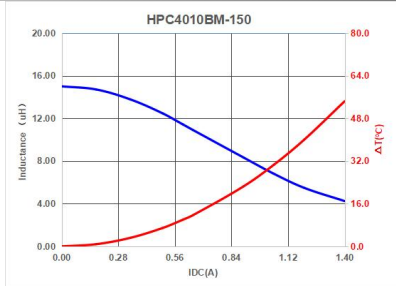

HPC4012BM

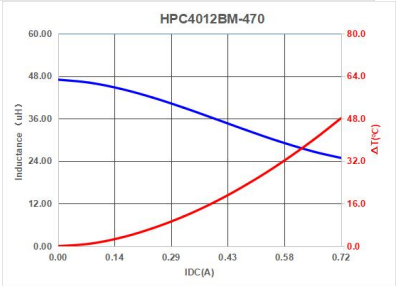
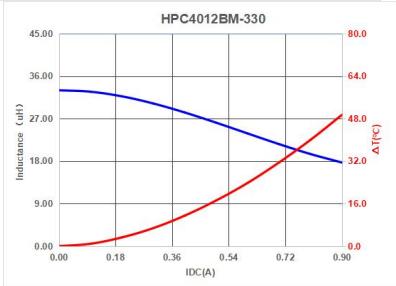
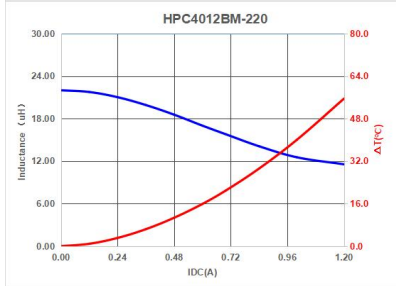
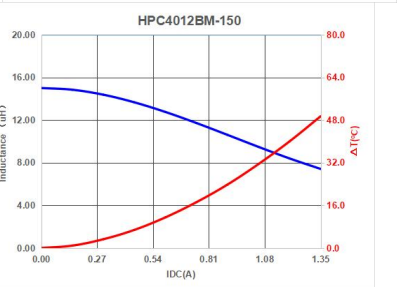
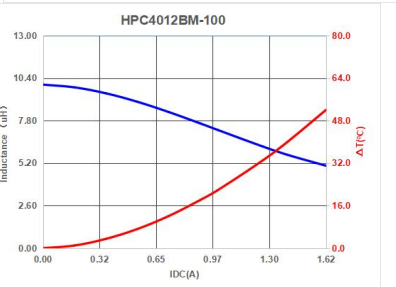
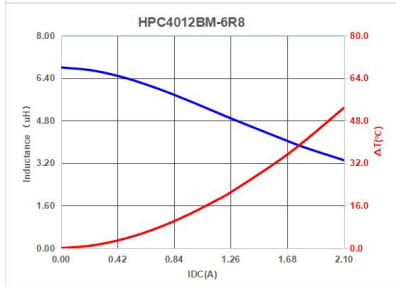
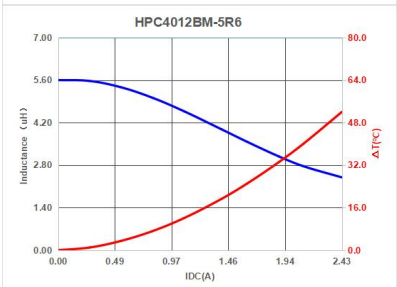
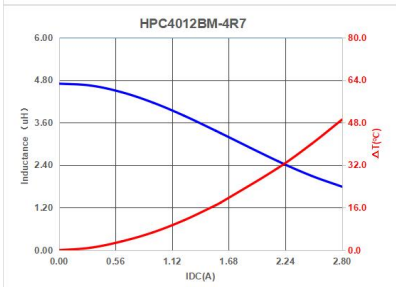
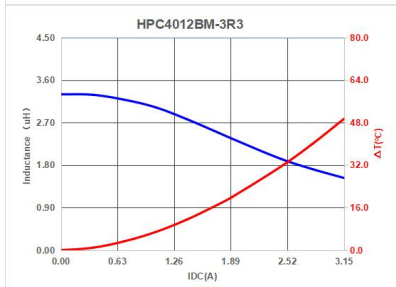
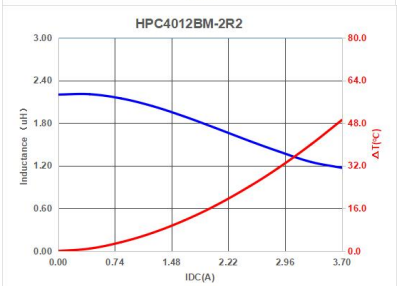
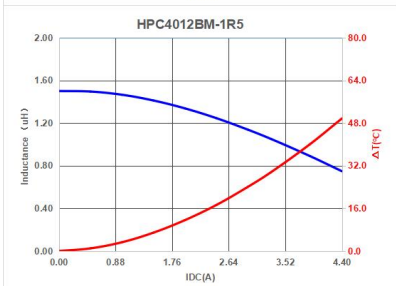
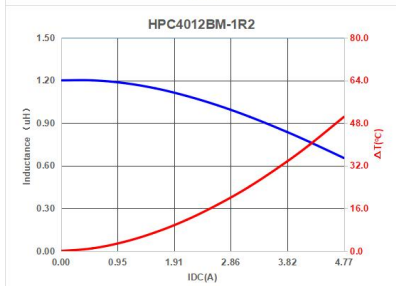
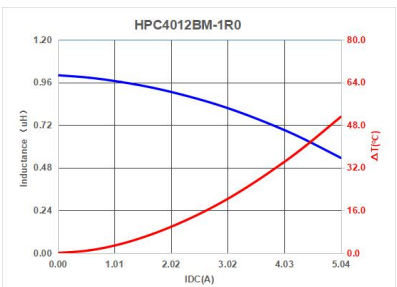
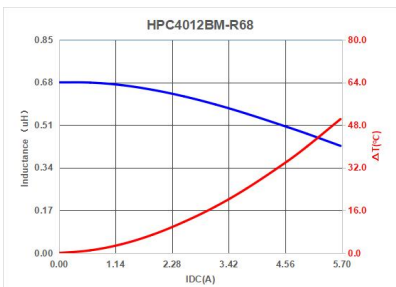
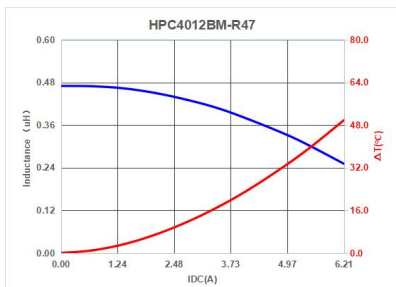

HPC4018BM

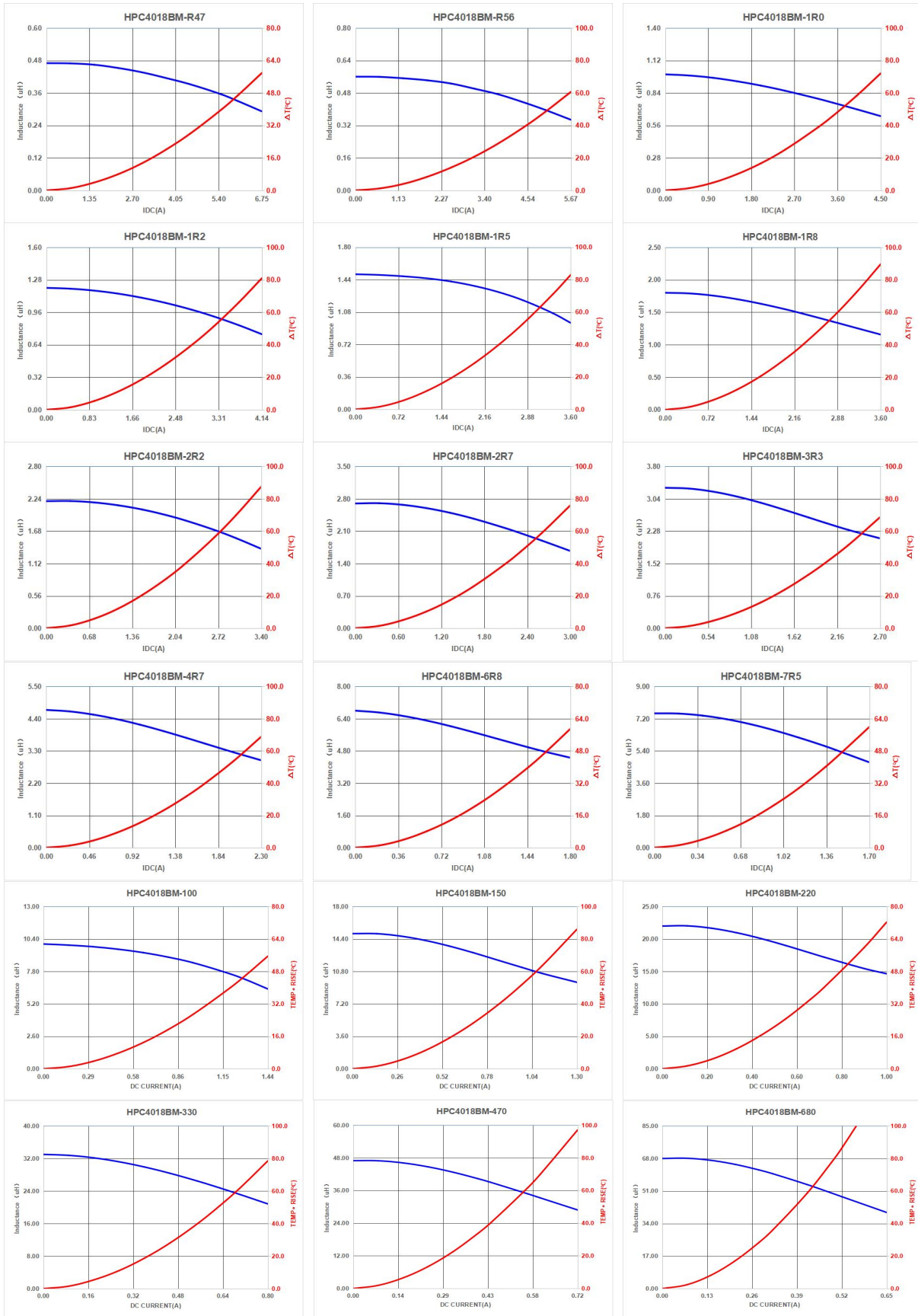

HPC4020BM

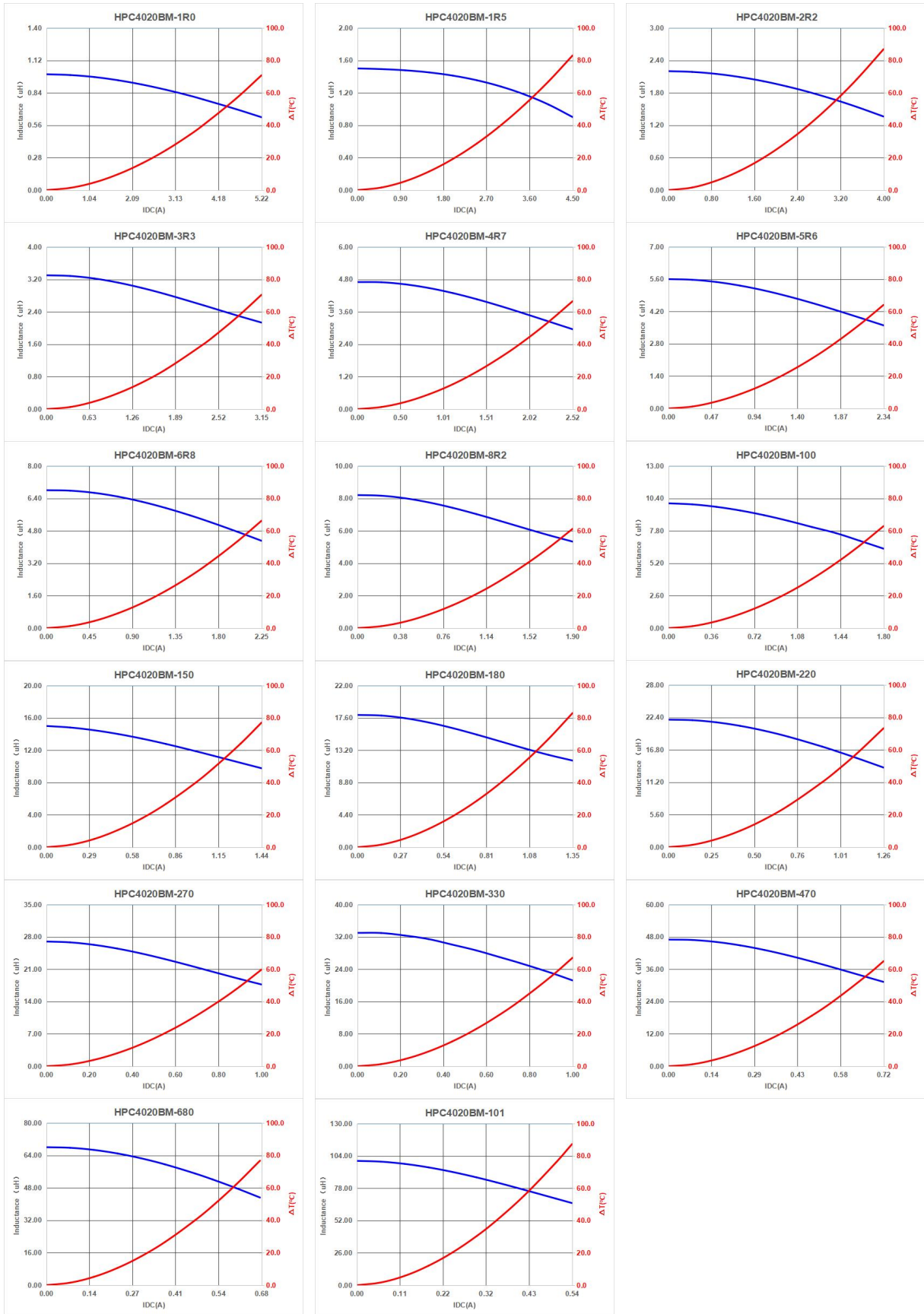

HPC4030NF

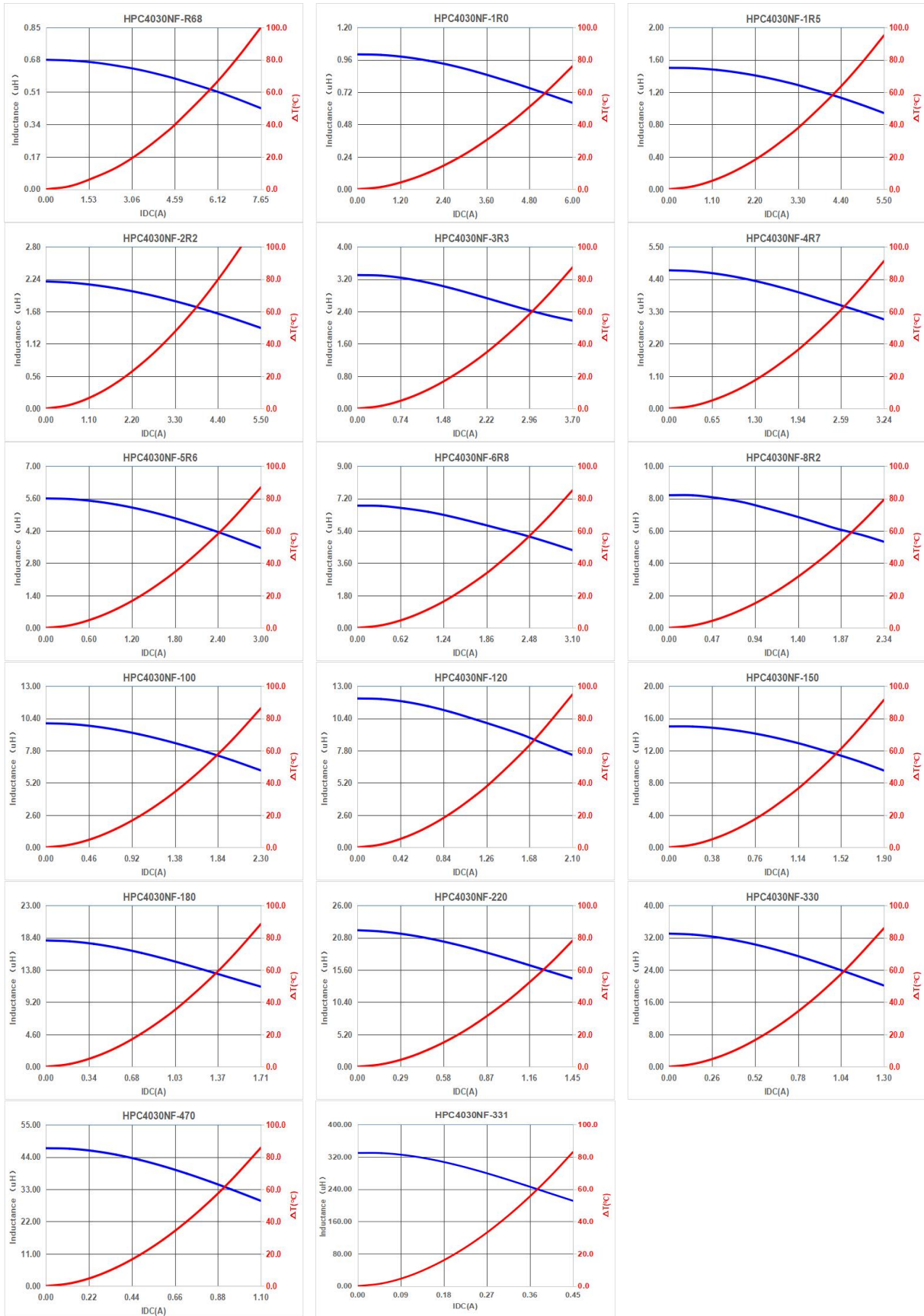

HPC5010NF

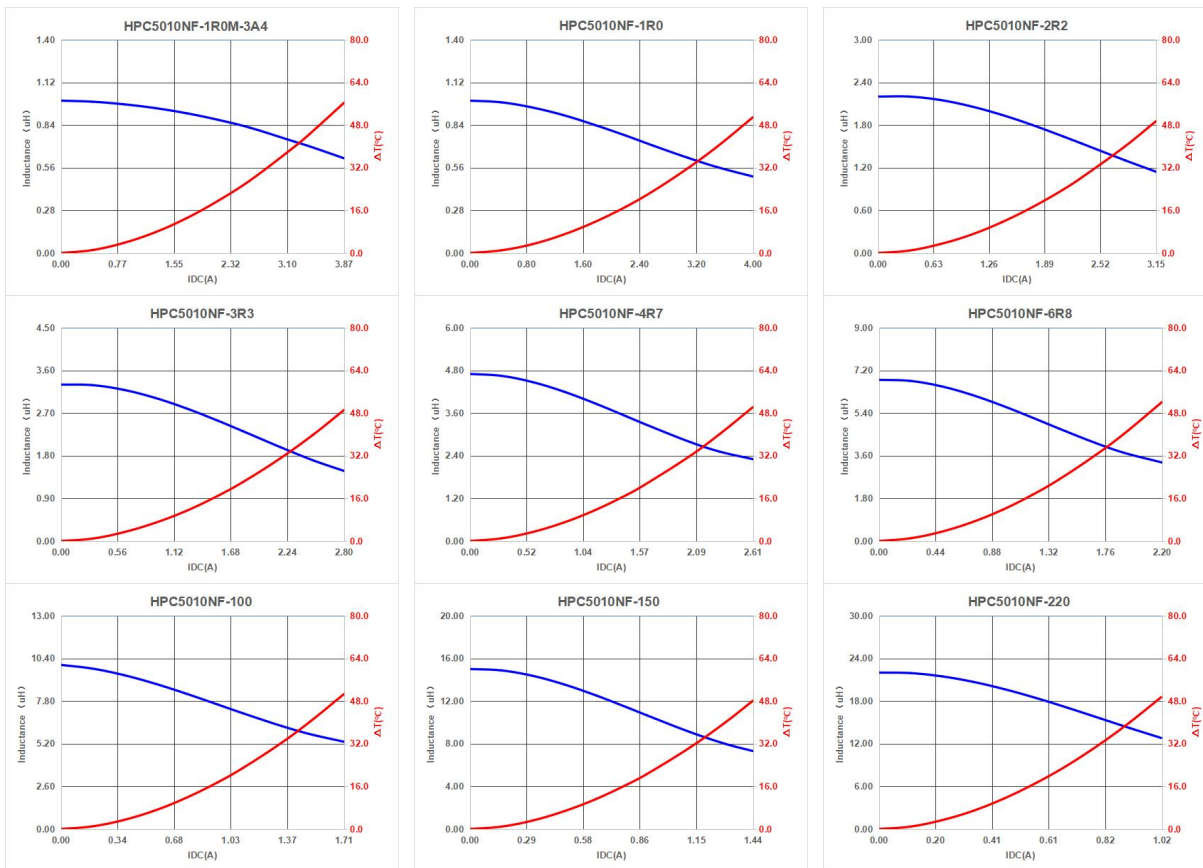

HPC5012NF

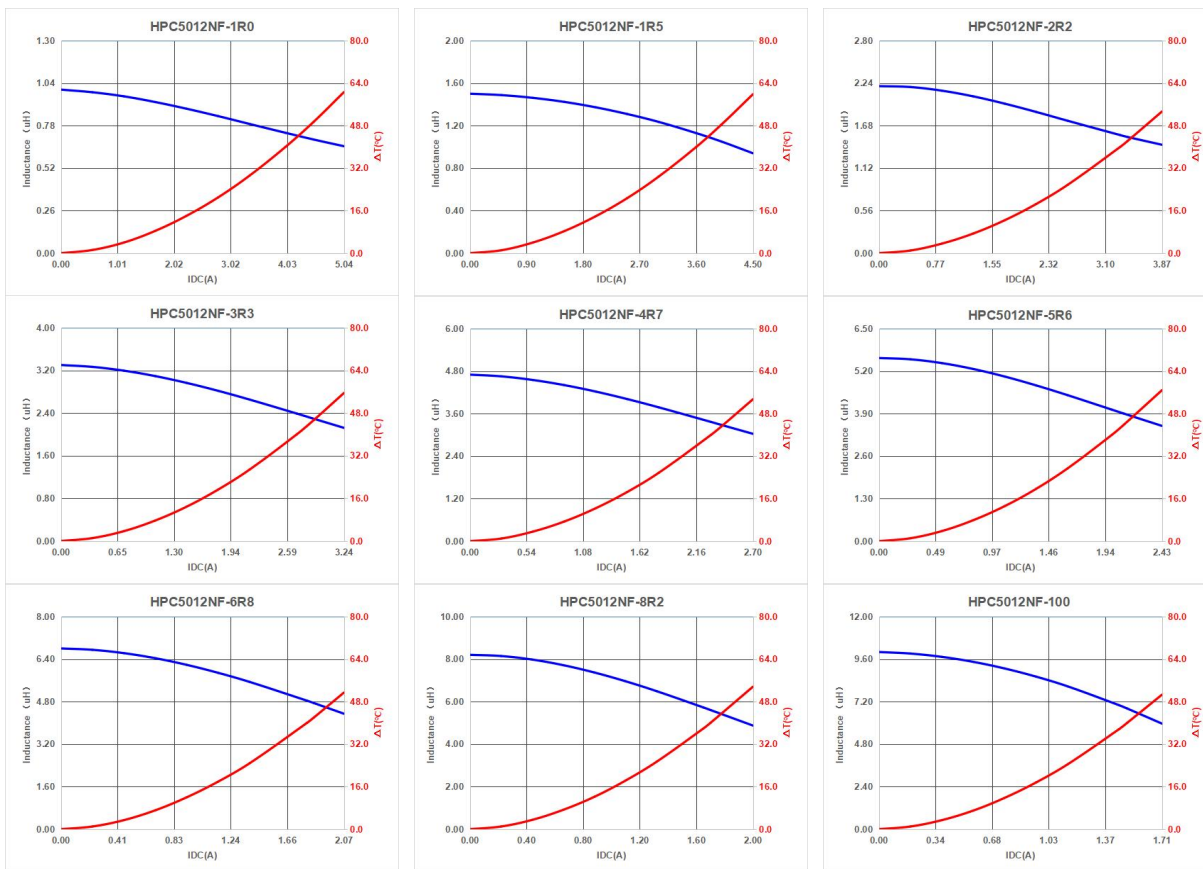

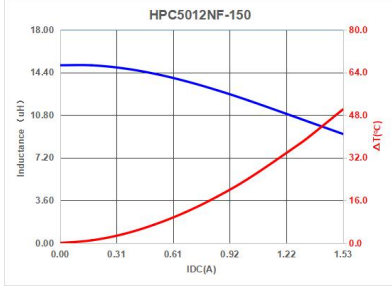

HPC5020NF

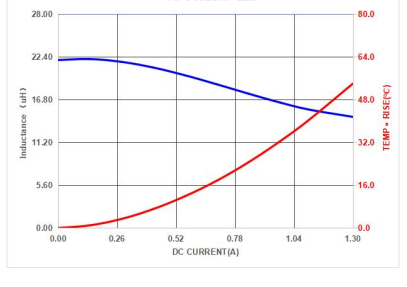
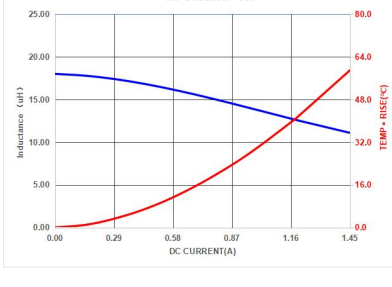
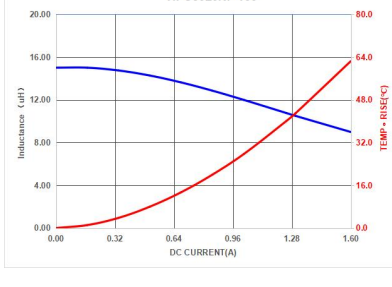
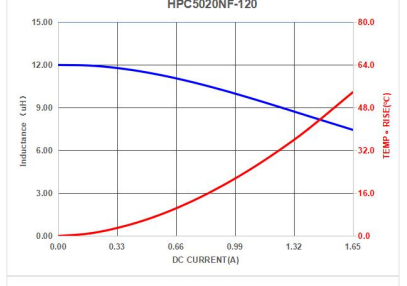
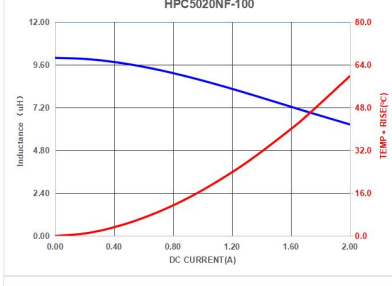
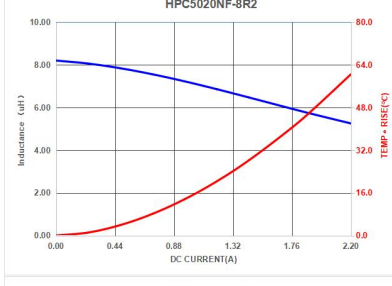
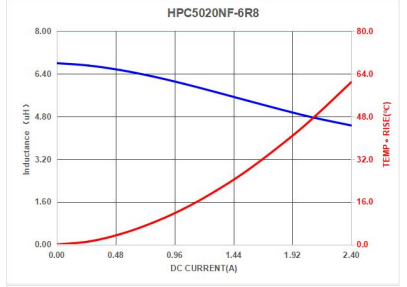
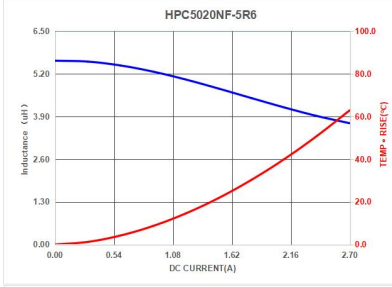
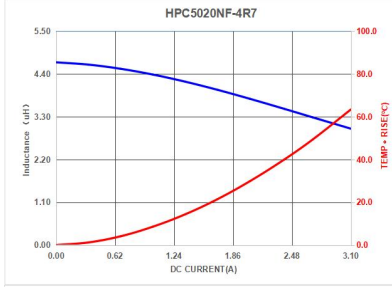
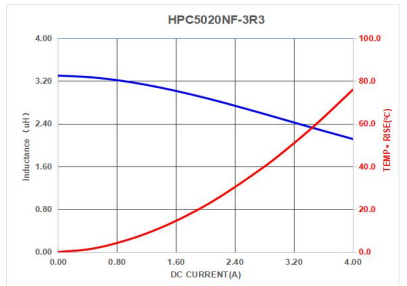
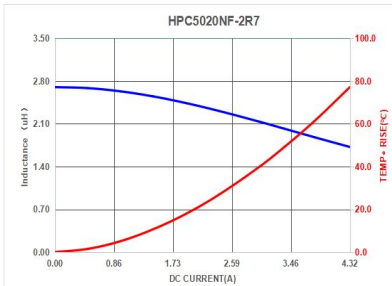
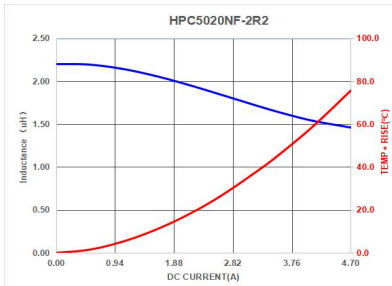
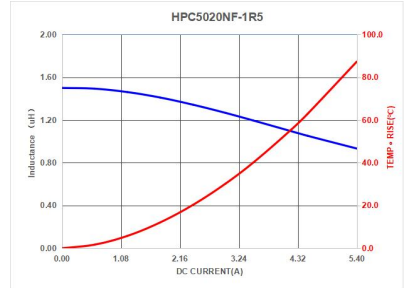
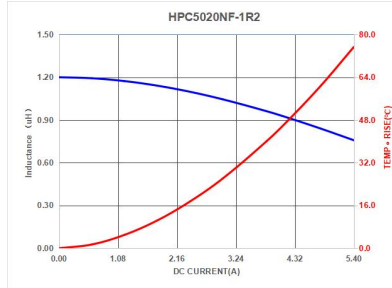
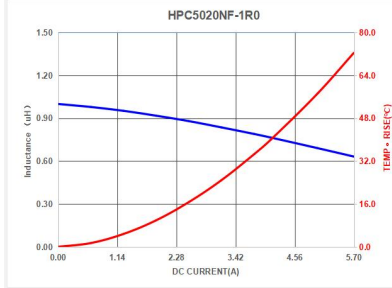

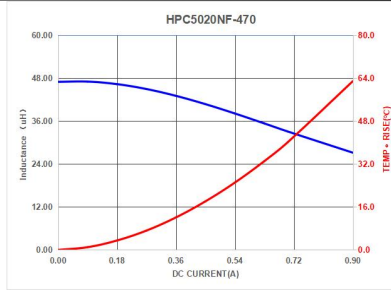
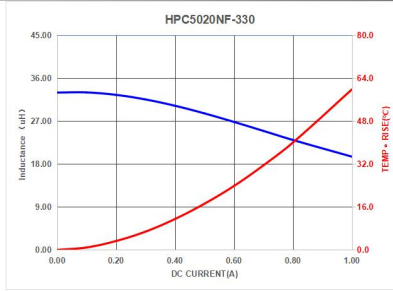

HPC5030NF

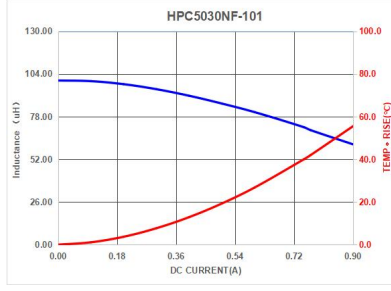
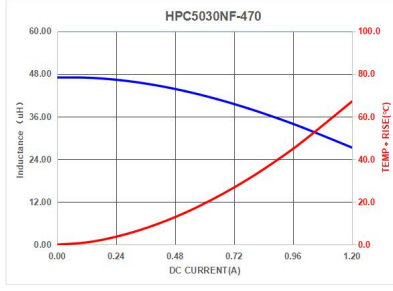
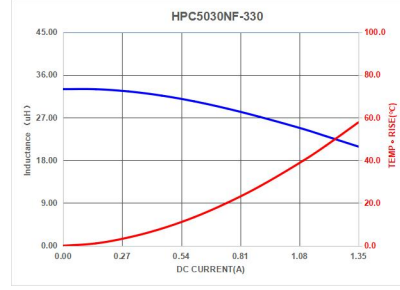
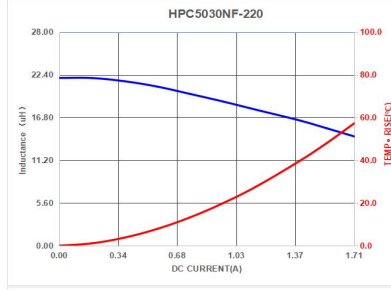
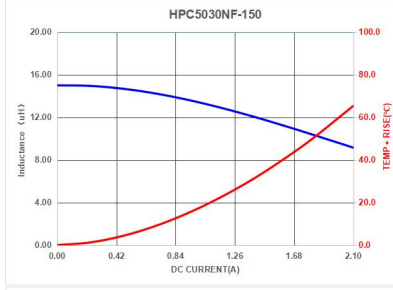
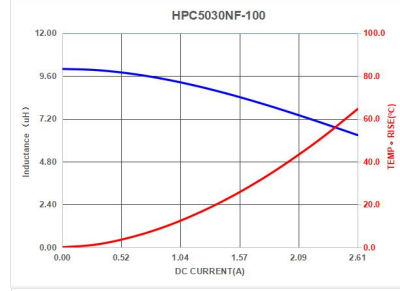
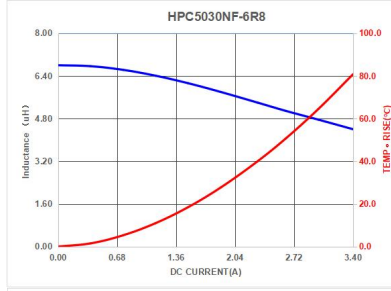
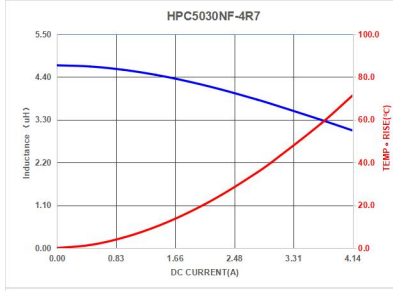
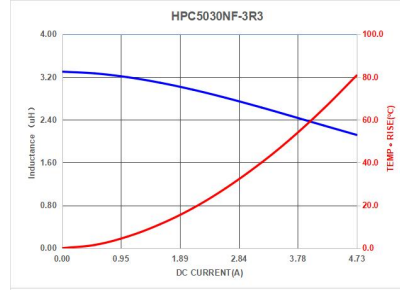
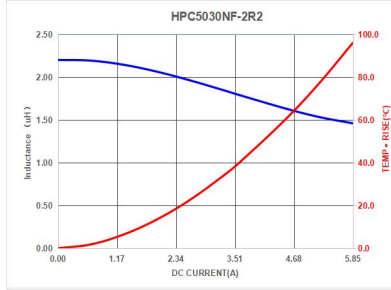
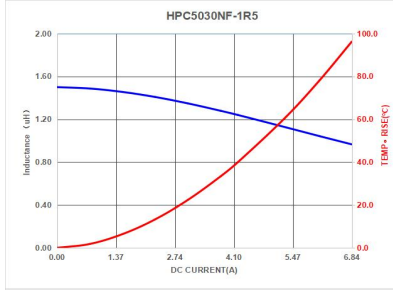
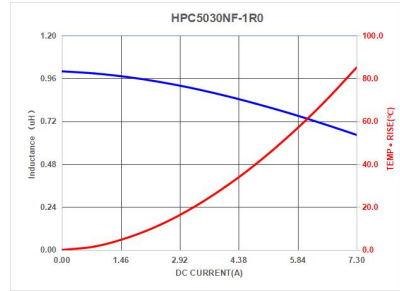
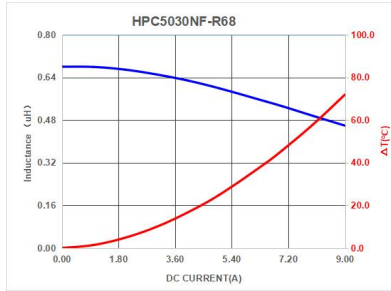
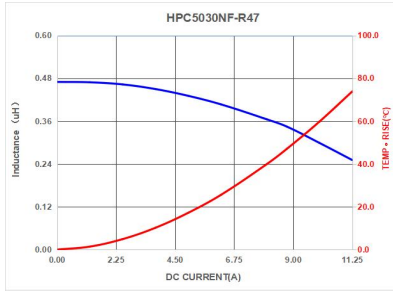

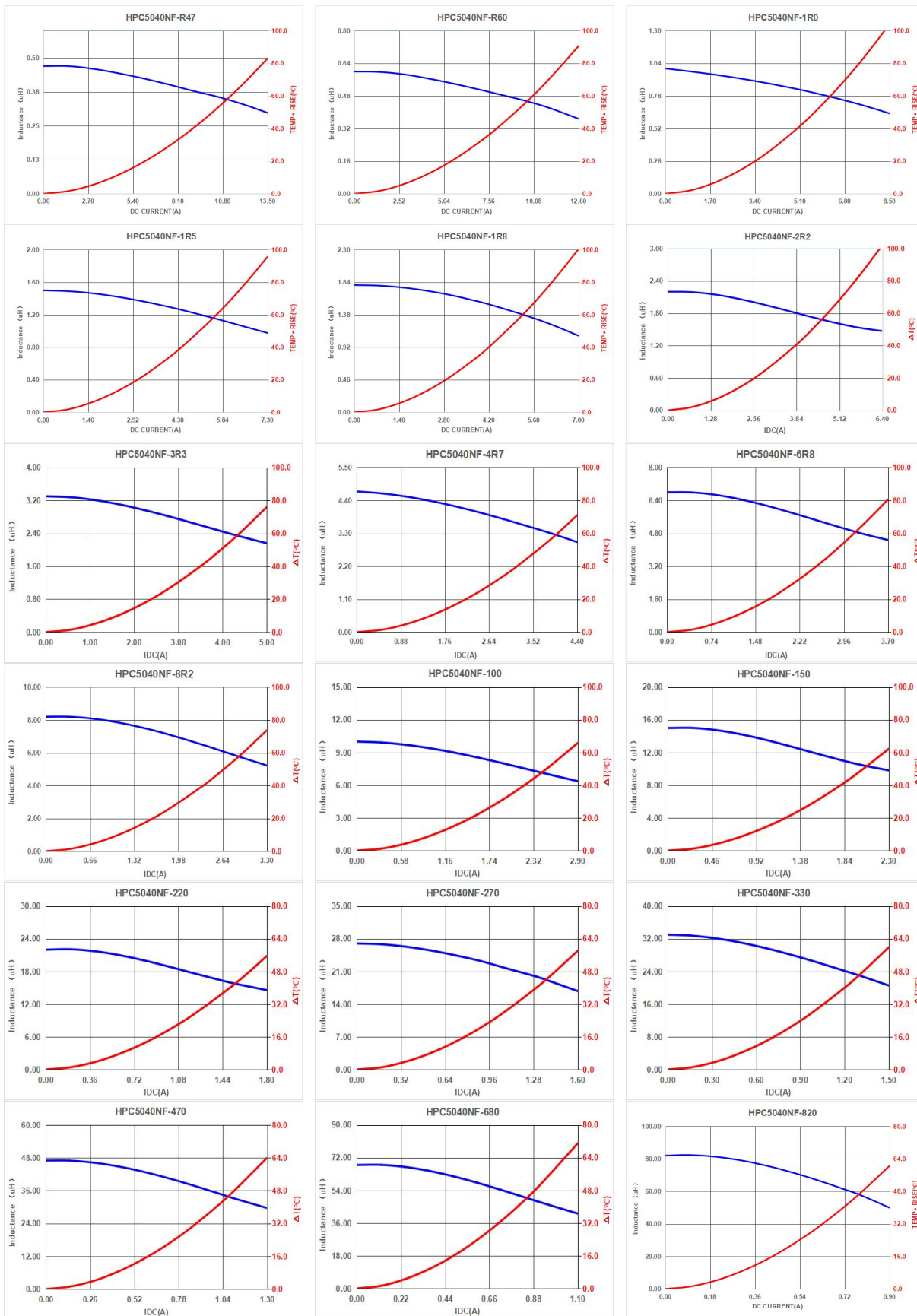

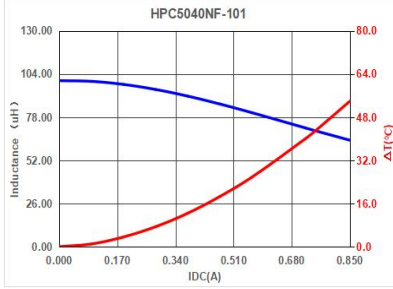

HPC6020NF

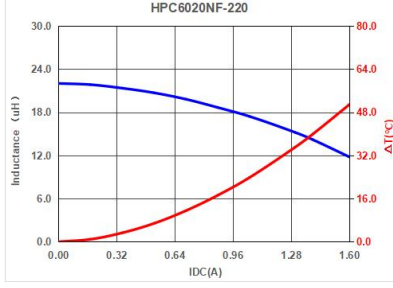
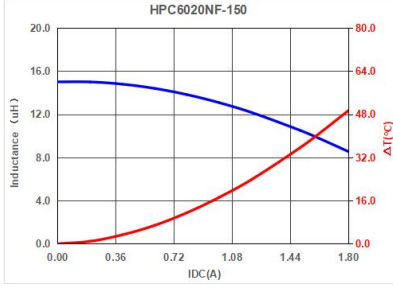
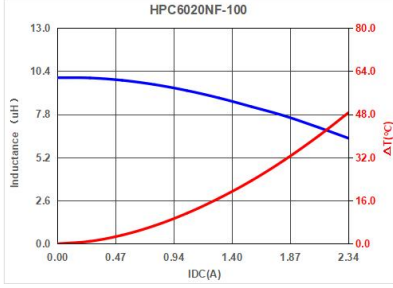
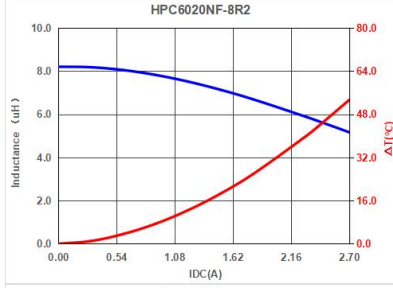
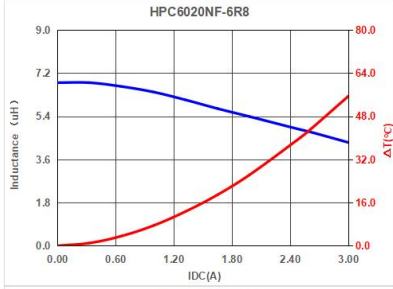
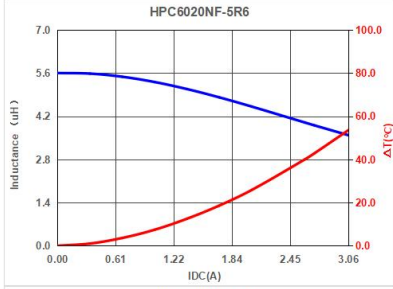
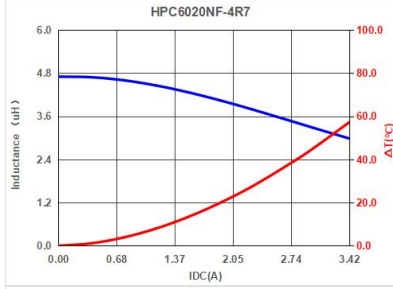
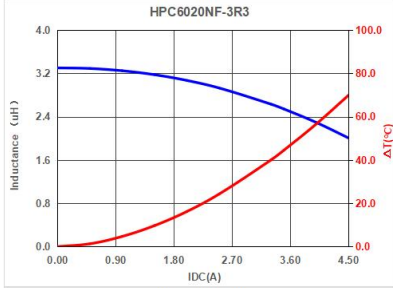
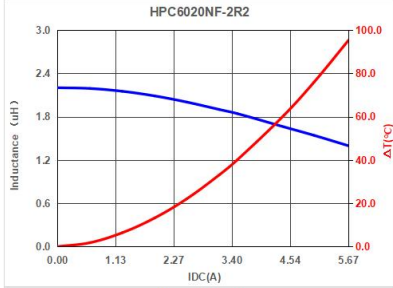
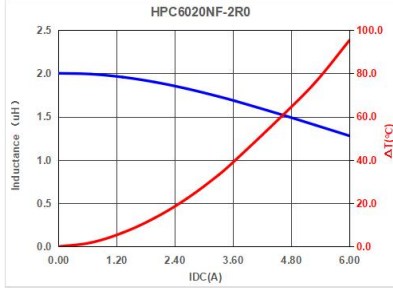
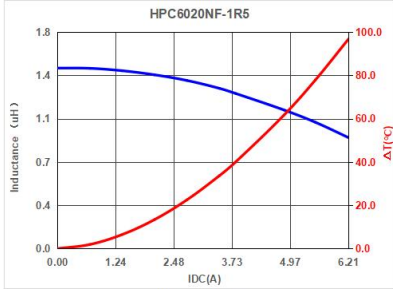
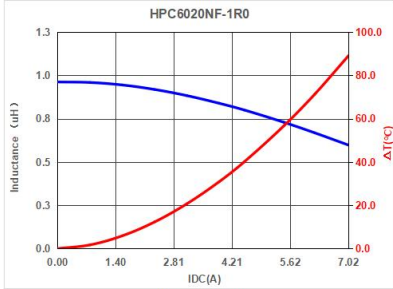
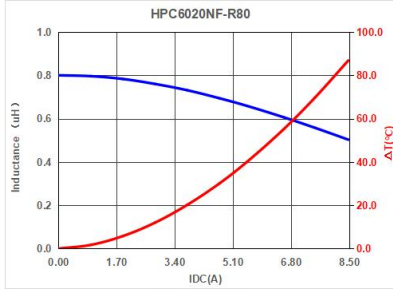

HPC6028NF

