



Phase Control Thyristors (Stud Version), 80 A



TO-94 (TO-209AC)

FEATURES

- Hermetic glass-metal seal
- International standard case TO-94 (TO-209AC)
- Designed and qualified for industrial level
- Material categorization: For definitions of compliance please see www.vishay.com/doc?99912



RoHS
COMPLIANT

TYPICAL APPLICATIONS

- DC motor controls
- Controlled DC power supplies
- AC controllers

PRIMARY CHARACTERISTICS	
$I_{T(AV)}$	80 A
V_{DRM}/V_{RRM}	400 V, 800 V, 1200 V
V_{TM}	1.60 V
I_{GT}	120 mA
T_J	-40 °C to +125 °C
Package	TO-94 (TO-209AC)
Circuit configuration	Single SCR

MAJOR RATINGS AND CHARACTERISTICS			
PARAMETER	TEST CONDITIONS	VALUES	UNITS
$I_{T(AV)}$		80	A
	T_C	85	°C
$I_{T(RMS)}$		125	A
I_{TSM}	50 Hz	1900	
	60 Hz	1990	
I^2t	50 Hz	18	kA ² s
	60 Hz	16	
V_{DRM}/V_{RRM}		400 to 1200	V
t_q	Typical	110	µs
T_J		-40 to +125	°C

ELECTRICAL SPECIFICATIONS

VOLTAGE RATINGS				
TYPE NUMBER	VOLTAGE CODE	V_{DRM}/V_{RRM} , MAXIMUM REPETITIVE PEAK AND OFF-STATE VOLTAGE V	V_{RSM} , MAXIMUM NON-REPETITIVE PEAK VOLTAGE V	I_{DRM}/I_{RRM} MAXIMUM AT $T_J = 125\text{ °C}$ mA
VS-80RIA VS-81RIA	40	400	500	15
	80	800	900	
	120	1200	1300	



ABSOLUTE MAXIMUM RATINGS					
PARAMETER	SYMBOL	TEST CONDITIONS		VALUES	UNITS
Maximum average on-state current at case temperature	$I_{T(AV)}$	180° conduction, half sine wave		80	A
				85	°C
Maximum RMS on-state current	$I_{T(RMS)}$	DC at 75 °C case temperature		125	
Maximum peak, one-cycle non-repetitive surge current	I_{TSM}	t = 10 ms	No voltage reappplied	1900	A
		t = 8.3 ms		100 % V_{RRM} reappplied	
		t = 10 ms	Sinusoidal half wave, initial $T_J = T_J$ maximum		
		t = 8.3 ms		1675	
Maximum I^2t for fusing	I^2t	t = 10 ms	No voltage reappplied	18	kA ² s
		t = 8.3 ms		100 % V_{RRM} reappplied	
		t = 10 ms	Sinusoidal half wave, initial $T_J = T_J$ maximum		
		t = 8.3 ms		11.7	
Maximum $I^2\sqrt{t}$ for fusing	$I^2\sqrt{t}$	t = 0.1 ms to 10 ms, no voltage reappplied		180.5	kA ² √s
Low level value of threshold voltage	$V_{T(TO)1}$	$(16.7\% \times \pi \times I_{T(AV)} < I < \pi \times I_{T(AV)})$, $T_J = T_J$ maximum		0.99	V
High level value of threshold voltage	$V_{T(TO)2}$	$(I > \pi \times I_{T(AV)})$, $T_J = T_J$ maximum		1.13	
Low level value of on-state slope resistance	r_{t1}	$(16.7\% \times \pi \times I_{T(AV)} < I < \pi \times I_{T(AV)})$, $T_J = T_J$ maximum		2.29	mΩ
High level value of on-state slope resistance	r_{t2}	$(I > \pi \times I_{T(AV)})$, $T_J = T_J$ maximum		1.84	
Maximum on-state voltage	V_{TM}	$I_{pk} = 250$ A, $T_J = 25$ °C, $t_p = 10$ ms sine pulse		1.60	V
Maximum holding current	I_H	$T_J = 25$ °C, anode supply 12 V resistive load		200	mA
Typical latching current	I_L			400	

SWITCHING					
PARAMETER	SYMBOL	TEST CONDITIONS		VALUES	UNITS
Maximum non-repetitive rate of rise of turned-on current	di/dt	$T_J = 125$ °C, $V_d = \text{Rated } V_{DRM}$, $I_{TM} = 2 \times di/dt$ snubber 0.2 μF, 15 Ω, gate pulse: 20 V, 65 Ω, $t_p = 6$ μs, $t_r = 0.5$ μs Per JEDEC standard RS-397, 5.2.2.6.		300	A/μs
Typical delay time	t_d	Gate pulse: 10 V, 15 Ω source, $t_p = 6$ μs, $t_r = 0.1$ μs, $V_d = \text{Rated } V_{DRM}$, $I_{TM} = 50$ Adc, $T_J = 25$ °C		1	μs
Typical turn-off time	t_q	$I_{TM} = 50$ A, $T_J = T_J$ maximum, di/dt = -5 A/μs, $V_R = 50$ V, dV/dt = 20 V/μs, gate bias: 0 V 25 Ω, $t_p = 500$ μs		110	

BLOCKING					
PARAMETER	SYMBOL	TEST CONDITIONS		VALUES	UNITS
Maximum critical rate of rise of off-state voltage	dV/dt	$T_J = 125$ °C exponential to 67 % rated V_{DRM}		500	V/μs
Maximum peak reverse and off-state leakage current	I_{RRM} , I_{DRM}	$T_J = 125$ °C rated V_{DRM}/V_{RRM} applied		15	mA



TRIGGERING					
PARAMETER	SYMBOL	TEST CONDITIONS		VALUES	UNITS
Maximum peak gate power	P_{GM}	$T_J = T_J$ maximum, $t_p \leq 5$ ms		12	W
Maximum average gate power	$P_{G(AV)}$	$T_J = T_J$ maximum, $f = 50$ Hz, $d\% = 50$		3	
Maximum peak positive gate current	I_{GM}	$T_J = T_J$ maximum, $t_p \leq 5$ ms		3	A
Maximum peak positive gate voltage	$+V_{GM}$			20	
Maximum peak negative gate voltage	$-V_{GM}$			10	
Maximum DC gate current required to trigger	I_{GT}	$T_J = -40$ °C	Maximum required gate trigger/ current/voltage are the lowest value which will trigger all units 6 V anode to cathode applied	270	mA
		$T_J = 25$ °C		120	
		$T_J = 125$ °C		60	
Maximum DC gate voltage required to trigger	V_{GT}	$T_J = -40$ °C		3.5	V
		$T_J = 25$ °C		2.5	
		$T_J = 125$ °C		1.5	
DC gate current not to trigger	I_{GD}	$T_J = T_J$ maximum	Maximum gate current/voltage not to trigger is the maximum value which will not trigger any unit with rated V_{DRM} anode to cathode applied	6	mA
DC gate voltage not to trigger	V_{GD}			0.25	V

THERMAL AND MECHANICAL SPECIFICATIONS					
PARAMETER	SYMBOL	TEST CONDITIONS		VALUES	UNITS
Maximum operating junction temperature range	T_J			- 40 to 125	°C
Maximum storage temperature range	T_{Stg}			- 40 to 150	
Maximum thermal resistance, junction to case	R_{thJC}	DC operation		0.30	K/W
Maximum thermal resistance, case to heatsink	R_{thCS}	Mounting surface, smooth, flat and greased		0.1	
Mounting torque, ± 10 %		Non-lubricated threads		15.5 (137)	N · m (lbf · in)
		Lubricated threads		14 (120)	
Approximate weight				130	g
Case style		See dimensions - link at the end of datasheet		TO-94 (TO-209AC)	

ΔR_{thJC} CONDUCTION				
CONDUCTION ANGLE	SINUSOIDAL CONDUCTION	RECTANGULAR CONDUCTION	TEST CONDITIONS	UNITS
180°	0.042	0.030	$T_J = T_J$ maximum	K/W
120°	0.050	0.052		
90°	0.064	0.070		
60°	0.095	0.100		
30°	0.164	0.165		

Note

- The table above shows the increment of thermal resistance R_{thJC} when devices operate at different conduction angles than DC



VS-80RIA...PbF, VS-81RIA...PbF, VS-82RIA...PbF Series

www.vishay.com

Vishay Semiconductors

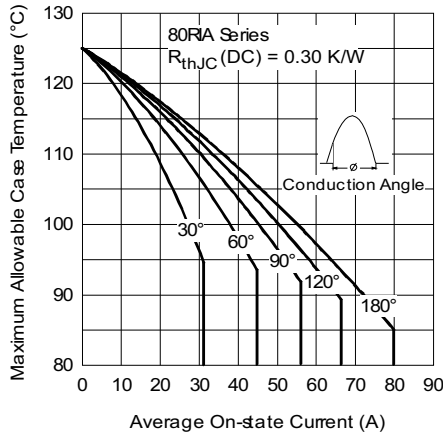

Fig. 1 - Current Ratings Characteristics

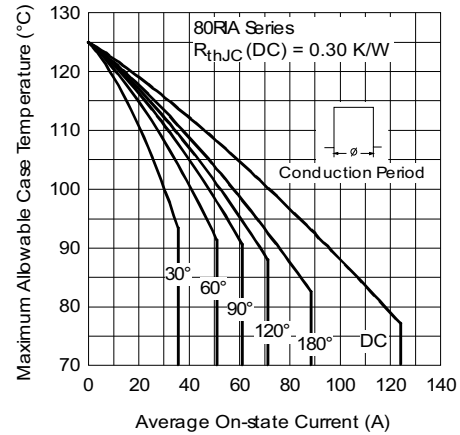

Fig. 2 - Current Ratings Characteristics

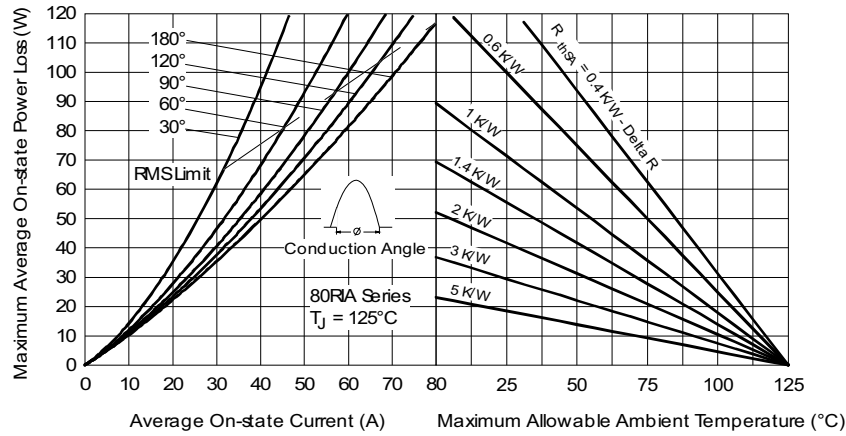

Fig. 3 - On-State Power Loss Characteristics

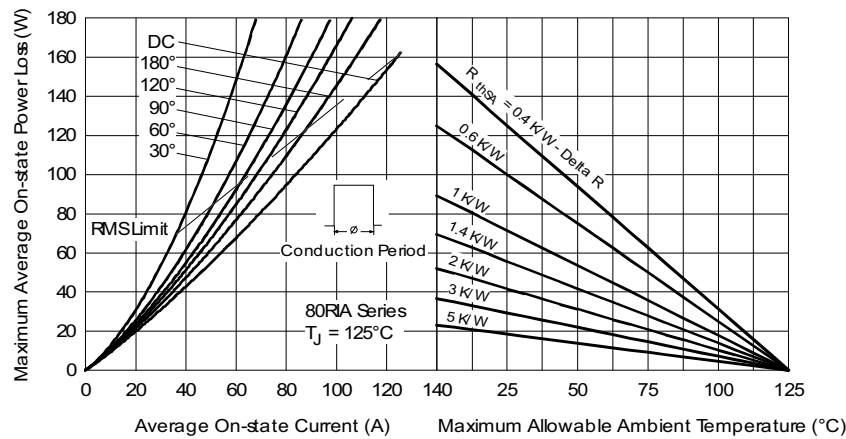

Fig. 4 - On-State Power Loss Characteristics

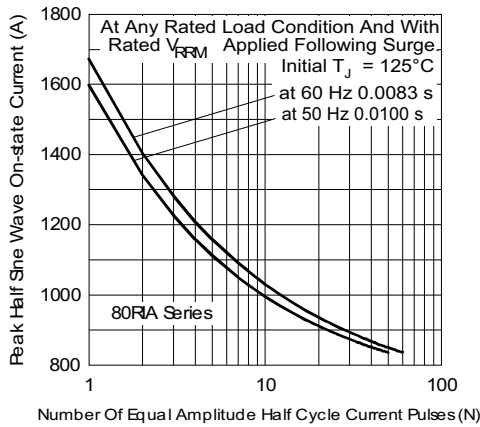

Fig. 5 - Maximum Non-Repetitive Surge Current

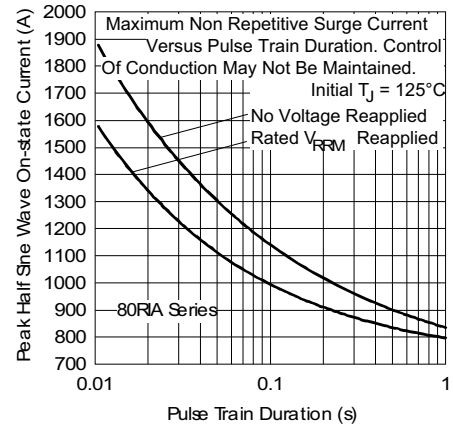

Fig. 6 - Maximum Non-Repetitive Surge Current

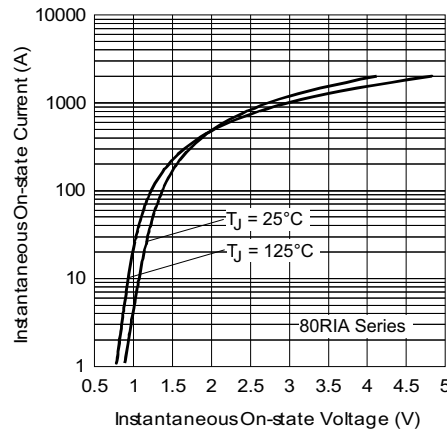

Fig. 7 - On-State Voltage Drop Characteristics

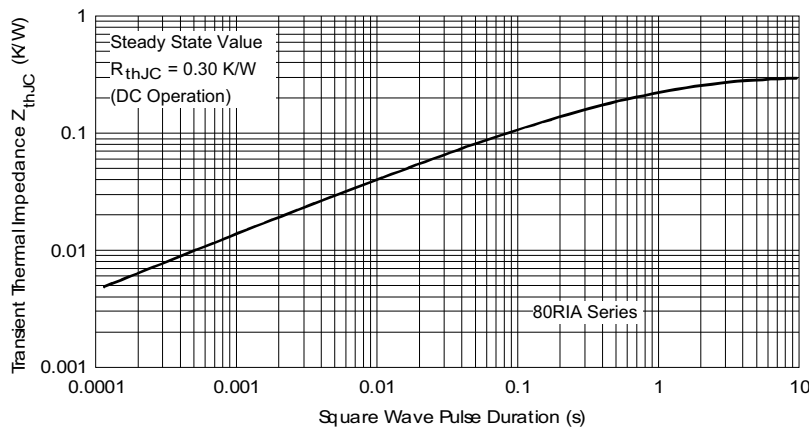

Fig. 8 - Thermal Impedance Z_{thJC} Characteristics

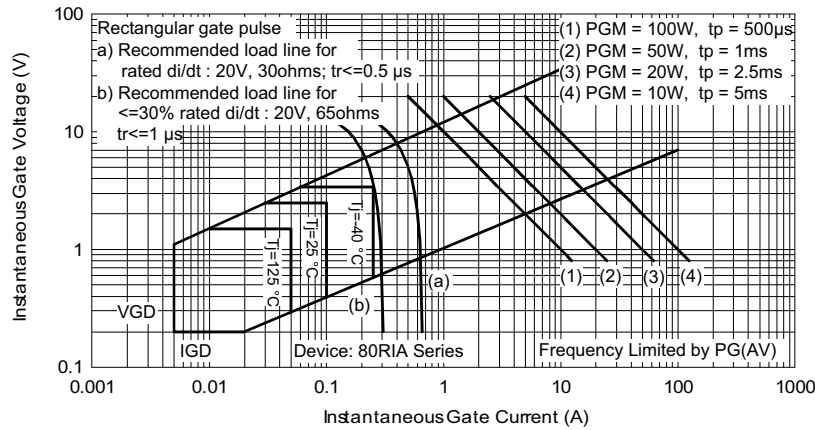

Fig. 9 - Gate Characteristics

ORDERING INFORMATION TABLE

Device code	VS-	8	0	RIA	120	M	PbF
	(1)	(2)	(3)	(4)	(5)	(6)	(7)

- 1** - Vishay Semiconductors product
- 2** - $I_{TAV} \times 10$ A
- 3** -
 - 0 = eyelet terminals (gate and auxiliary cathode leads)
 - 1 = fast-on terminals (gate and auxiliary cathode leads)
 - 2 = flag terminals (gate and auxiliary cathode terminals)
- 4** - RIA = essential part number
- 5** - Voltage code $\times 100 = V_{RRM}$ (see Voltage Ratings table)
- 6** -
 - None = stud base 1/2"-20UNF- 2 A threads
 - M = stud base metric threads M12 x 1.75 E 6
- 7** -
 - None = standard production
 - PbF = lead (Pb)-free

LINKS TO RELATED DOCUMENTS	
Dimensions	www.vishay.com/doc?95362

TO-209AC (TO-94) for 80RIA Series

DIMENSIONS in millimeters (inches)

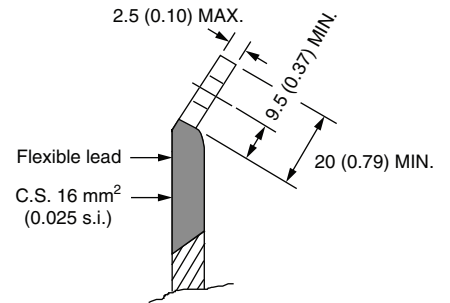



Disclaimer

ALL PRODUCT, PRODUCT SPECIFICATIONS AND DATA ARE SUBJECT TO CHANGE WITHOUT NOTICE TO IMPROVE RELIABILITY, FUNCTION OR DESIGN OR OTHERWISE.

Vishay Intertechnology, Inc., its affiliates, agents, and employees, and all persons acting on its or their behalf (collectively, "Vishay"), disclaim any and all liability for any errors, inaccuracies or incompleteness contained in any datasheet or in any other disclosure relating to any product.

Vishay makes no warranty, representation or guarantee regarding the suitability of the products for any particular purpose or the continuing production of any product. To the maximum extent permitted by applicable law, Vishay disclaims (i) any and all liability arising out of the application or use of any product, (ii) any and all liability, including without limitation special, consequential or incidental damages, and (iii) any and all implied warranties, including warranties of fitness for particular purpose, non-infringement and merchantability.

Statements regarding the suitability of products for certain types of applications are based on Vishay's knowledge of typical requirements that are often placed on Vishay products in generic applications. Such statements are not binding statements about the suitability of products for a particular application. It is the customer's responsibility to validate that a particular product with the properties described in the product specification is suitable for use in a particular application. Parameters provided in datasheets and / or specifications may vary in different applications and performance may vary over time. All operating parameters, including typical parameters, must be validated for each customer application by the customer's technical experts. Product specifications do not expand or otherwise modify Vishay's terms and conditions of purchase, including but not limited to the warranty expressed therein.

Hyperlinks included in this datasheet may direct users to third-party websites. These links are provided as a convenience and for informational purposes only. Inclusion of these hyperlinks does not constitute an endorsement or an approval by Vishay of any of the products, services or opinions of the corporation, organization or individual associated with the third-party website. Vishay disclaims any and all liability and bears no responsibility for the accuracy, legality or content of the third-party website or for that of subsequent links.

Except as expressly indicated in writing, Vishay products are not designed for use in medical, life-saving, or life-sustaining applications or for any other application in which the failure of the Vishay product could result in personal injury or death. Customers using or selling Vishay products not expressly indicated for use in such applications do so at their own risk. Please contact authorized Vishay personnel to obtain written terms and conditions regarding products designed for such applications.

No license, express or implied, by estoppel or otherwise, to any intellectual property rights is granted by this document or by any conduct of Vishay. Product names and markings noted herein may be trademarks of their respective owners.