



ERT2AF SERIES

SURFACE MOUNT SUPERFAST RECTIFIER

VOLTAGE 50~600 Volt **CURRENT** 2 Ampere

SMBF Unit : inch(mm)

FEATURES

- For surface mounted applications in order to optimize board space
- High temperature metallurgically bonded-no compression
- Plastic package has Underwriters Laboratory Flammability Classification 94V-O
- Ultra thin profile package for space constrained utilization
- Easy pick and place package suitable for automated handling
- Glass passivated junction with epi wafer
- Hyperfast recovery time
- Lead free in compliance with EU RoHS 2011/65/EU directive
- Green molding compound as per IEC61249 Std. . (Halogen Free)

MECHANICAL DATA

- Case: SMBF molded plastic
- Terminals: Solder plated, solderable per MIL-STD-750,Method 2026
- Approx. Weight: 0.0018 ounces, 0.05 grams
- Polarity: Color band denotes cathode end

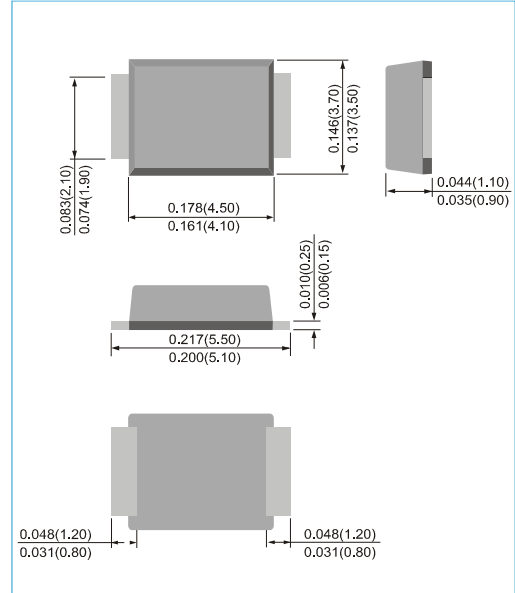
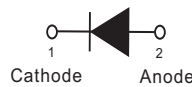

MAXIMUM RATINGS AND ELECTRICAL CHARACTERISTICS (T_A=25°C unless otherwise noted)

PARAMETER	SYMBOL	ERT2AF	ERT2BF	ERT2CF	ERT2DF	ERT2EF	ERT2GF	ERT2JF	UNITS	
Recurrent Peak Reverse Voltage	V _{RRM}	50	100	150	200	300	400	600	V	
RMS Voltage	V _{RMS}	35	70	105	140	210	280	420	V	
DC Blocking Voltage	V _R	50	100	150	200	300	400	600	V	
Average Forward Current	I _{F(AV)}	2							A	
Peak Forward Surge Current : 8.3ms single half sine-wave superimposed on rated load	I _{FSM}	50							A	
Forward Voltage at 2A	V _F	0.95			1.25		1.7		V	
DC Reverse Current at Rated DC Blocking Voltage T _J =25°C	I _R	1							μA	
Typical Junction Capacitance (Note 1)	C _J	35			25		15		pF	
Typical Thermal Resistance ,Junction to Lead (Note 3) Junction to Ambient (Note 4)	R _{θJL} R _{θJA}	20 135								°C / W
Reverse Recovery Time (Note 2)	T _{rr}	25								ns
Operating Junction Temperature and Storage Temperature Range	T _J , T _{STG}	-55 to +150							°C	

- NOTES:1.Measured at 1 MHz and Applied Reverse Voltage of 4 Volt.
 2.Reverse Recovery Test Conditions: IF=0.5A, IR=1A, Recover to 0.25A.
 3.Mounted on a FR4 PCB, single-sided copper, with 10cm*10cm copper pad area
 4.Mounted on a FR4 PCB, single-sided copper, mini pad.



ERT2AF SERIES

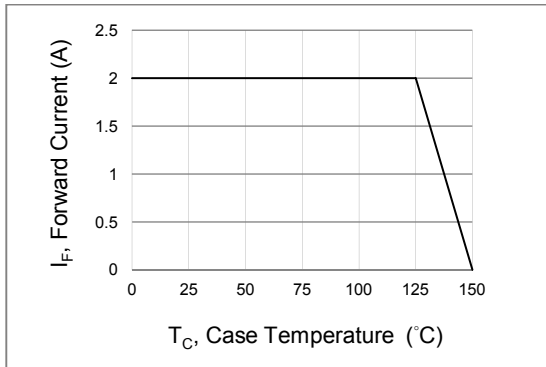

Fig.1 Forward Current Derating Curve

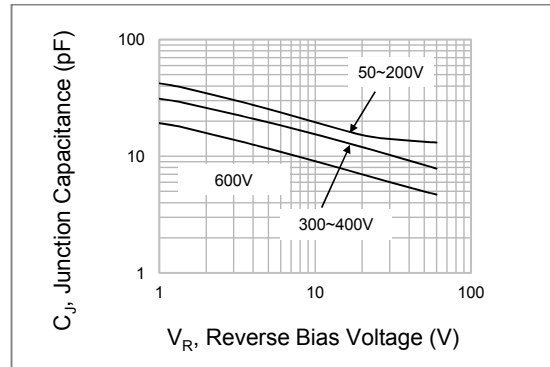

Fig.2 Typical Junction Capacitance

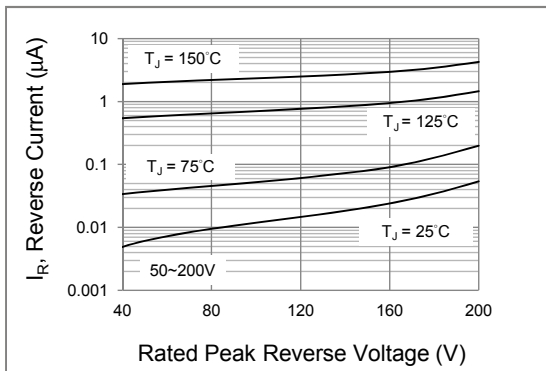

Fig.3 Typical Reverse Characteristics

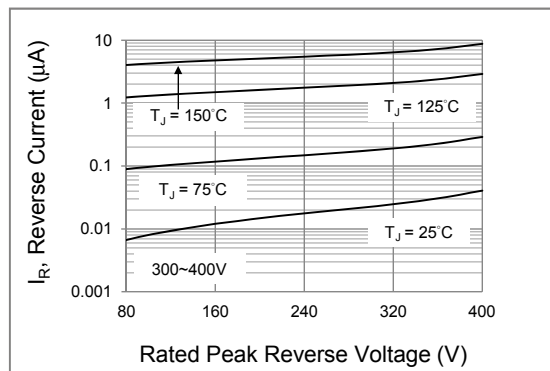

Fig.4 Typical Reverse Characteristics

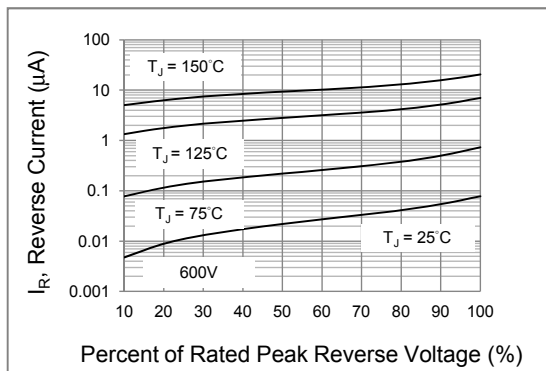

Fig.5 Typical Reverse Characteristics

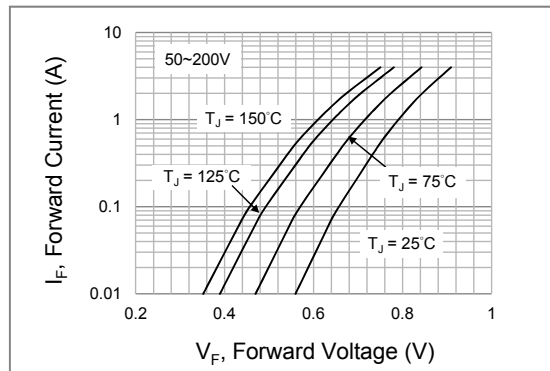

Fig.6 Typical Forward Characteristics

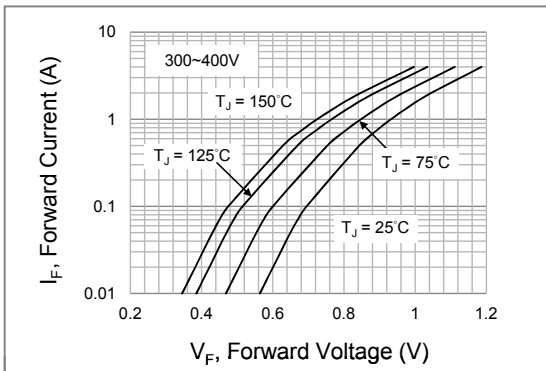

Fig.7 Typical Forward Characteristics

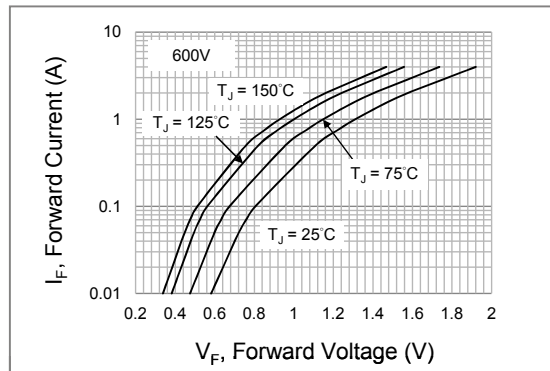
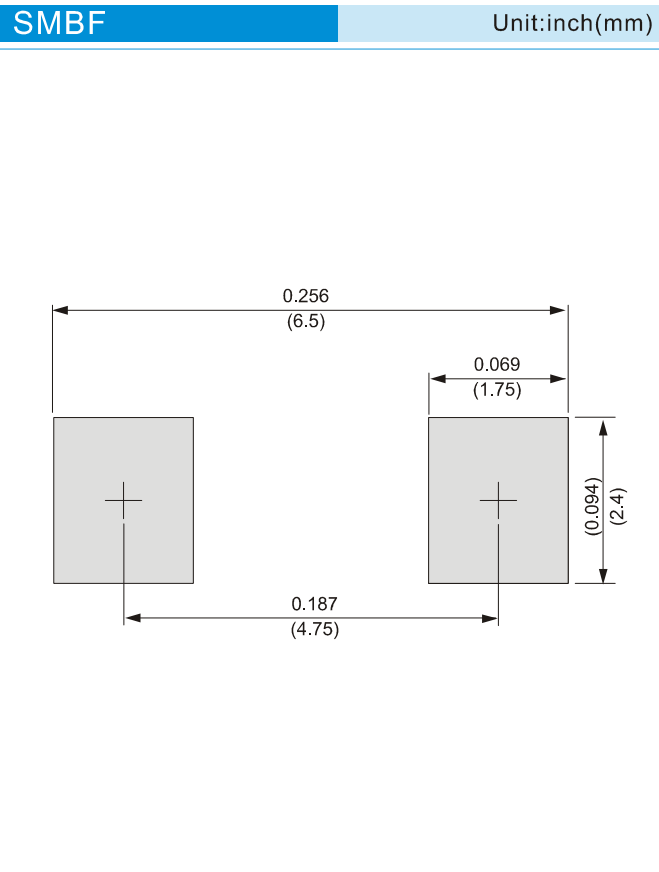

Fig.8 Typical Forward Characteristics



ERT2AF SERIES

MOUNTING PAD LAYOUT



ORDER INFORMATION

- Packing information
T/R - 5K per 13" plastic Reel



ERT2AF SERIES

Part No_packing code_Version

ERT2AF_R2_00001

For example :

RB500V-40_R2_00001



Packing Code XX				Version Code XXXXX		
Packing type	1 st Code	Packing size code	2 nd Code	HF or RoHS	1 st Code	2 nd ~5 th Code
Tape and Ammunition Box (T/B)	A	N/A	0	HF	0	serial number
Tape and Reel (T/R)	R	7"	1	RoHS	1	serial number
Bulk Packing (B/P)	B	13"	2			
Tube Packing (T/P)	T	26mm	X			
Tape and Reel (Right Oriented) (TRR)	S	52mm	Y			
Tape and Reel (Left Oriented) (TRL)	L	PANASERT T/B CATHODE UP (PBCU)	U			
FORMING	F	PANASERT T/B CATHODE DOWN (PBCD)	D			



ERT2AF SERIES

Disclaimer

- Reproducing and modifying information of the document is prohibited without permission from Panjit International Inc..
- Panjit International Inc. reserves the rights to make changes of the content herein the document anytime without notification. Please refer to our website for the latest document.
- Panjit International Inc. disclaims any and all liability arising out of the application or use of any product including damages incidentally and consequentially occurred.
- Panjit International Inc. does not assume any and all implied warranties, including warranties of fitness for particular purpose, non-infringement and merchantability.
- Applications shown on the herein document are examples of standard use and operation. Customers are responsible in comprehending the suitable use in particular applications. Panjit International Inc. makes no representation or warranty that such applications will be suitable for the specified use without further testing or modification.
- The products shown herein are not designed and authorized for equipments requiring high level of reliability or relating to human life and for any applications concerning life-saving or life-sustaining, such as medical instruments, transportation equipment, aerospace machinery et cetera. Customers using or selling these products for use in such applications do so at their own risk and agree to fully indemnify Panjit International Inc. for any damages resulting from such improper use or sale.
- Since Panjit uses lot number as the tracking base, please provide the lot number for tracking when complaining.