

Optocoupler, Phototransistor Output, Low Input Current, With Base Connection, 5300 V_{RMS}

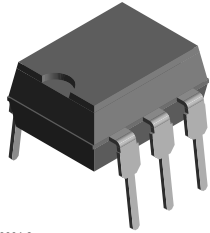
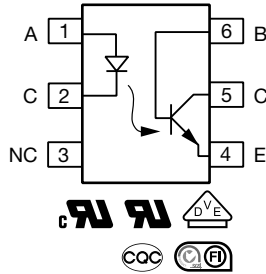

i179004-3

FEATURES

- Very high CTR at $I_F = 1.0 \text{ mA}$, $V_{CE} = 0.5 \text{ V}$
- Specified minimum CTR at $I_F = 0.5 \text{ mA}$
- $V_{CE} = 1.5 \text{ V} \geq 32 \%$ (typ. 120 %)
- Good CTR linearity with forward current
- Low CTR degradation
- High collector-emitter voltage, $V_{CEO} = 55 \text{ V}$
- Isolation test voltage: 5300 V_{RMS}
- Low current input
- Low coupling capacitance
- High common mode transient immunity
- Material categorization: for definitions of compliance please see www.vishay.com/doc?99912

RoHS
COMPLIANT

LINKS TO ADDITIONAL RESOURCES

[Product Page](#)
DESCRIPTION

The SFH608 is an optocoupler designed for high current transfer ratio at low input currents with the output transistor saturated. This makes the device ideal for low current switching applications. The SFH608 is packaged in a six pin plastic DIP.

AGENCY APPROVALS

- [UL 1577](#)
- [cUL](#)
- [DIN EN 60747-5-5 \(VDE 0884\)](#), available with option 1
- [BSI](#)
- [CQC GB4943.1](#)
- [CQC GB8898](#)
- [FIMKO](#)

APPLICATIONS

- Telecommunications
- Industrial controls
- Office machines
- Microprocessor system interfaces

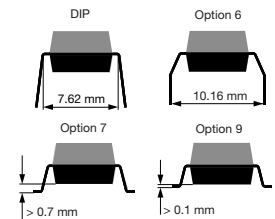
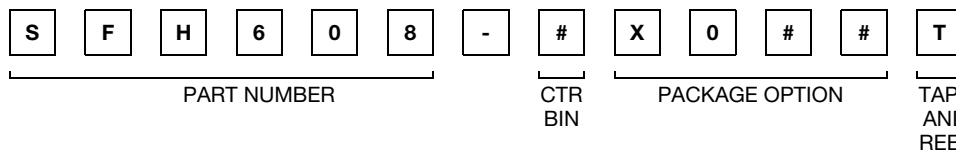
ORDERING INFORMATION

AGENCY CERTIFIED / PACKAGE	CTR (%)			
	63 to 125	100 to 200	160 to 320	250 to 500
UL, cUL, BSI, CQC				
DIP-6	SFH608-2	SFH608-3	SFH608-4	SFH608-5
DIP-6, 400 mil, option 6	SFH608-2X006	SFH608-3X006	-	-
SMD-6, option 7	-	SFH608-3X007 ⁽¹⁾	SFH608-4X007 ⁽¹⁾	SFH608-5X007
UL, cUL, BSI, CQC, VDE (option 1)				
DIP-6	-	SFH608-3X001	SFH608-4X001	-
DIP-6, 400 mil, option 6	-	-	SFH608-4X016	-

Notes

- Additional options may be possible, please contact sales office
- ⁽¹⁾ Also available in tubes; do not add T to end



ABSOLUTE MAXIMUM RATINGS ($T_{amb} = 25\text{ }^{\circ}\text{C}$, unless otherwise specified)				
PARAMETER	TEST CONDITION	SYMBOL	VALUE	UNIT
INPUT				
Reverse voltage		V_R	6	V
DC forward current		I_F	50	mA
Surge forward current	$t_p \leq 10\text{ }\mu\text{s}$	I_{FSM}	2.5	A
Total power dissipation		P_{diss}	70	mW
OUTPUT				
Collector emitter voltage		V_{CE}	55	V
Collector base voltage		V_{CBO}	55	V
Emitter base voltage		V_{EBO}	7	V
Collector current		I_C	50	mA
Surge collector current	$t_p \leq 1.0\text{ ms}$		100	mA
Total power dissipation		P_{diss}	150	mW
COUPLER				
Storage temperature range		T_{stg}	-55 to +150	$^{\circ}\text{C}$
Operating temperature range		T_{amb}	-55 to +100	$^{\circ}\text{C}$
Soldering temperature ⁽¹⁾	Max. 10 s, dip soldering; distance to seating plane $\geq 1.5\text{ mm}$	T_{sld}	260	$^{\circ}\text{C}$

Notes

- Stresses in excess of the absolute maximum ratings can cause permanent damage to the device. Functional operation of the device is not implied at these or any other conditions in excess of those given in the operational sections of this document. Exposure to absolute maximum ratings for extended periods of the time can adversely affect reliability.
- ⁽¹⁾ Refer to reflow profile for soldering conditions for surface mounted devices (SMD). Refer to wave profile for soldering conditions for through hole devices (DIP).

ELECTRICAL CHARACTERISTICS ($T_{amb} = 25\text{ }^{\circ}\text{C}$, unless otherwise specified)							
PARAMETER	TEST CONDITION	PART	SYMBOL	MIN.	TYP.	MAX.	UNIT
INPUT							
Forward voltage	$I_F = 5\text{ mA}$		V_F	-	1.1	1.5	V
Reverse voltage	$I_R = 10\text{ }\mu\text{A}$		V_R	6	-	-	V
Reverse current	$V_R = 6\text{ V}$		I_R	-	0.01	10	μA
Capacitance	$V_R = 0\text{ V}$, $f = 1\text{ MHz}$		C_O	-	25	-	pF
Thermal resistance			R_{thja}	-	1070	-	K/W
OUTPUT							
Collector emitter voltage	$I_{CE} = 10\text{ }\mu\text{A}$		V_{CEO}	55	-	-	V
Emitter base voltage	$I_{EB} = 10\text{ }\mu\text{A}$		V_{EBO}	7	-	-	V
Collector emitter capacitance	$V_{CE} = 5\text{ V}$, $f = 1\text{ MHz}$		C_{CE}	-	10	-	pF
Collector base capacitance	$V_{CE} = 5\text{ V}$, $f = 1\text{ MHz}$		C_{CB}	-	16	-	pF
Emitter base capacitance	$V_{CE} = 5\text{ V}$, $f = 1\text{ MHz}$		C_{EB}	-	10	-	pF
Thermal resistance			R_{thja}	-	500	-	K/W
Collector emitter leakage current	$V_{CE} = 10\text{ V}$		I_{CEO}	-	10	200	nA
COUPLER							
Coupling capacitance			C_C	-	0.6	-	pF
Saturation voltage, collector emitter	$I_C = 0.32\text{ mA}$, $I_F = 1\text{ mA}$	SFH608-2	V_{CEsat}	-	0.25	0.4	V
	$I_C = 0.5\text{ mA}$, $I_F = 1\text{ mA}$	SFH608-3	V_{CEsat}	-	0.25	0.4	V
	$I_C = 0.8\text{ mA}$, $I_F = 1\text{ mA}$	SFH608-4	V_{CEsat}	-	0.25	0.4	V
	$I_C = 1.25\text{ mA}$, $I_F = 1\text{ mA}$	SFH608-5	V_{CEsat}	-	0.25	0.4	V

Note

- Minimum and maximum values are testing requirements. Typical values are characteristics of the device and are the result of engineering evaluation. Typical values are for information only and are not part of the testing requirements.



CURRENT TRANSFER RATIO							
PARAMETER	TEST CONDITION	PART	SYMBOL	MIN.	TYP.	MAX.	UNIT
Coupling transfer ratio	$I_F = 1 \text{ mA}, V_{CC} = 0.5 \text{ V}$	SFH608-2	CTR	63	-	125	%
	$I_F = 0.5 \text{ mA}, V_{CC} = 1.5 \text{ V}$	SFH608-2	CTR	32	75	-	%
	$I_F = 1 \text{ mA}, V_{CC} = 0.5 \text{ V}$	SFH608-3	CTR	100	-	200	%
	$I_F = 0.5 \text{ mA}, V_{CC} = 1.5 \text{ V}$	SFH608-3	CTR	50	120	-	%
	$I_F = 1 \text{ mA}, V_{CC} = 0.5 \text{ V}$	SFH608-4	CTR	160	-	320	%
	$I_F = 0.5 \text{ mA}, V_{CC} = 1.5 \text{ V}$	SFH608-4	CTR	80	200	-	%
	$I_F = 1 \text{ mA}, V_{CC} = 0.5 \text{ V}$	SFH608-5	CTR	250	-	500	%
	$I_F = 0.5 \text{ mA}, V_{CC} = 1.5 \text{ V}$	SFH608-5	CTR	125	300	-	%

SWITCHING CHARACTERISTICS							
PARAMETER	TEST CONDITION	SYMBOL	MIN.	TYP.	MAX.	UNIT	
Turn-on time	$I_C = 2 \text{ mA}$ (to adjust by I_F), $R_L = 100 \Omega, V_{CC} = 5 \text{ V}$	t_{on}	-	8	-	μs	
Rise time	$I_C = 2 \text{ mA}$ (to adjust by I_F), $R_L = 100 \Omega, V_{CC} = 5 \text{ V}$	t_r	-	5	-	μs	
Turn-off time	$I_C = 2 \text{ mA}$ (to adjust by I_F), $R_L = 100 \Omega, V_{CC} = 5 \text{ V}$	t_{off}	-	7.5	-	μs	
Fall time	$I_C = 2 \text{ mA}$ (to adjust by I_F), $R_L = 100 \Omega, V_{CC} = 5 \text{ V}$	t_f	-	7	-	μs	

SAFETY AND INSULATION RATINGS				
PARAMETER	TEST CONDITION	SYMBOL	VALUE	UNIT
Climatic classification	According to IEC 68 part 1		55 / 100 / 21	
Comparative tracking index		CTI	175	
Maximum rated withstanding isolation voltage	$t = 1 \text{ min}$	V_{ISO}	4420	V_{RMS}
Maximum transient isolation voltage		V_{IOTM}	8000	V
Maximum repetitive peak isolation voltage		V_{IORM}	890	V
Isolation resistance	$V_{IO} = 500 \text{ V}, T_{amb} = 25 \text{ }^\circ\text{C}$	R_{IO}	$\geq 10^{12}$	Ω
	$V_{IO} = 500 \text{ V}, T_{amb} = 100 \text{ }^\circ\text{C}$	R_{IO}	$\geq 10^{11}$	Ω
Output safety power		P_{SO}	700	mW
Input safety current		I_{SI}	400	mA
Input safety temperature		T_{SI}	175	$^\circ\text{C}$
Creepage distance	Standard DIP-4		≥ 7	mm
Clearance distance	Standard DIP-4		≥ 7	mm
Creepage distance	400 mil DIP-4		≥ 8	mm
Clearance distance	400 mil DIP-4		≥ 8	mm
Insulation thickness		DTI	≥ 0.4	mm

Note

- As per IEC 60747-5-5, § 7.4.3.8.2, this optocoupler is suitable for "safe electrical insulation" only within the safety ratings. Compliance with the safety ratings shall be ensured by means of protective circuits.

TYPICAL CHARACTERISTICS ($T_{amb} = 25\text{ }^{\circ}\text{C}$, unless otherwise specified)

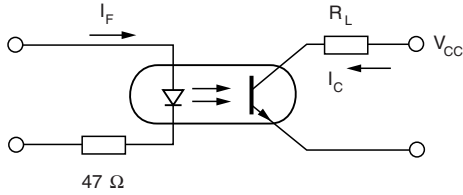

isfh608_01

Fig. 1 - Switching Schematic

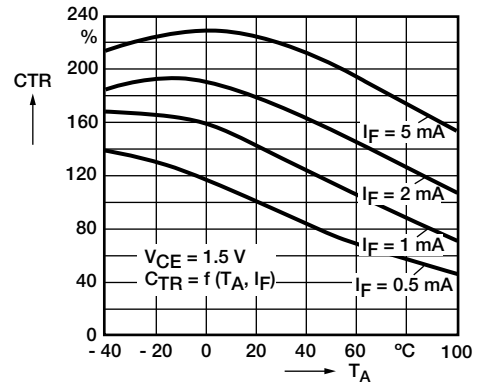

isfh608_04

Fig. 4 - Current Transfer Ratio (typ.)

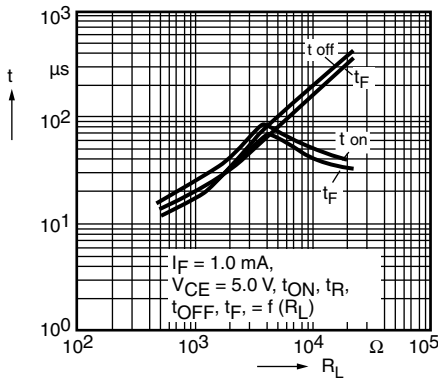

isfh608_02

Fig. 2 - Switching Times

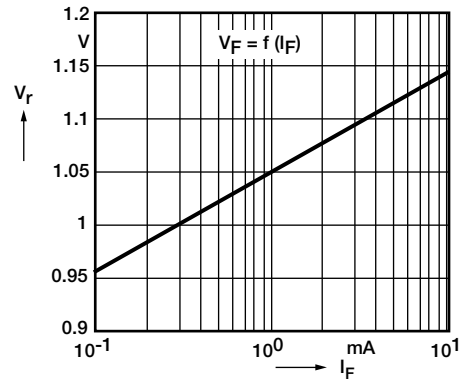

isfh608_05

Fig. 5 - Diode Forward Voltage (typ.)

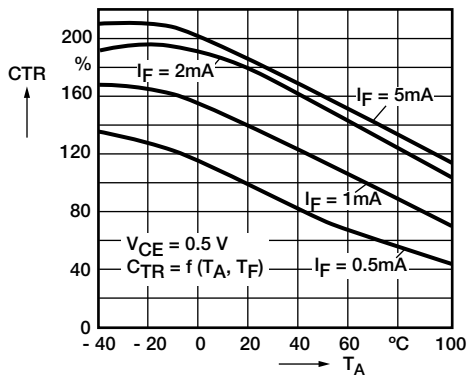

isfh608_03

Fig. 3 - Current Transfer Ratio (typ.)

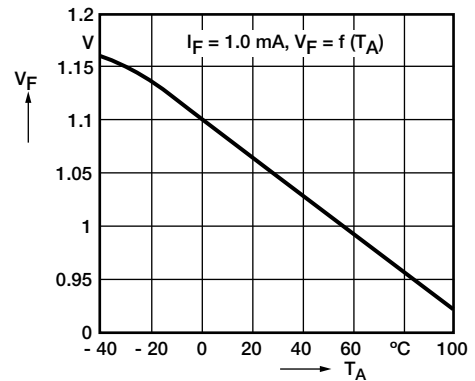

isfh608_06

Fig. 6 - Diode Forward Voltage (typ.)

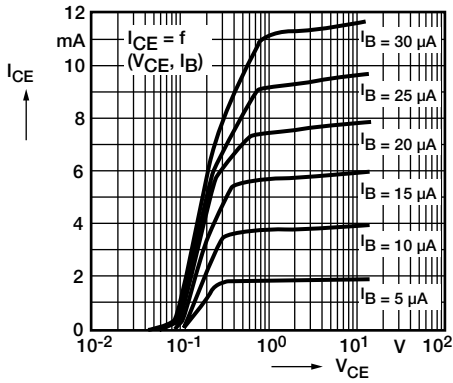

isfh608_07

Fig. 7 - Output Characteristics

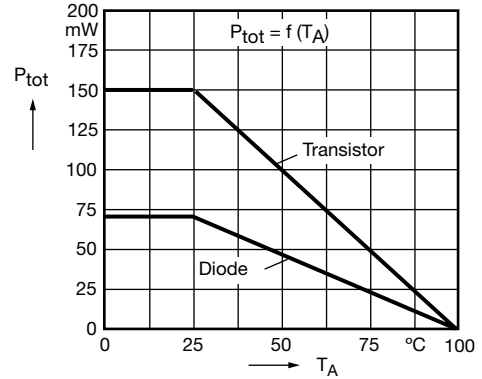

isfh608_10

Fig. 10 - Permissible Power Dissipation for Transistor and Diode

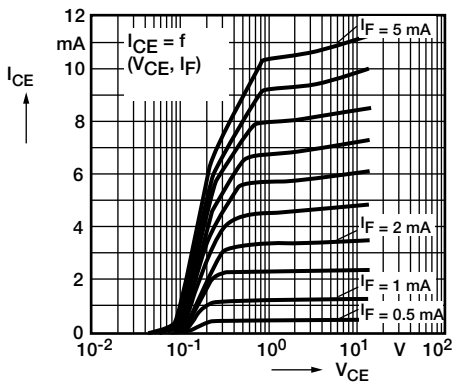

isfh608_08

Fig. 8 - Output Characteristics

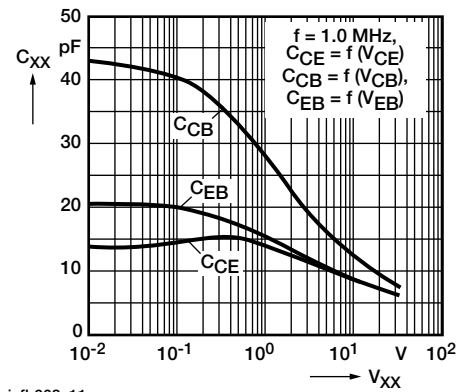

isfh608_11

Fig. 11 - Transistor Capacitance

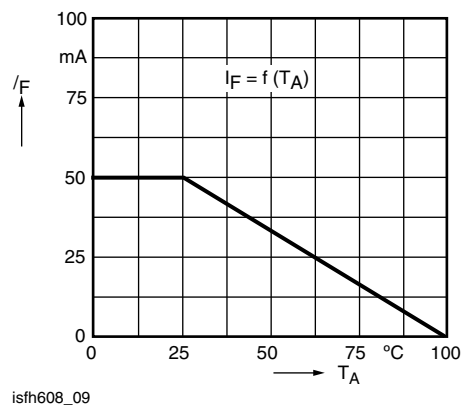

isfh608_09

Fig. 9 - Permissible Forward Current Diode

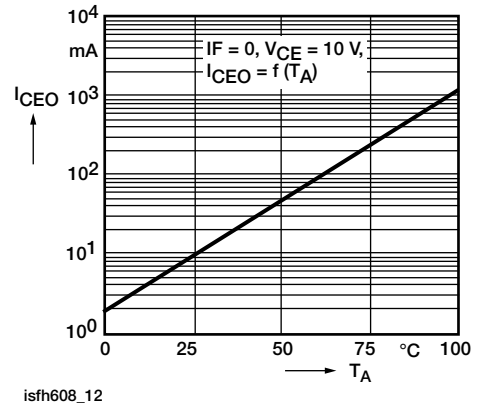

isfh608_12

Fig. 12 - Collector Emitter Leakage Current vs. Temperature

PACKAGE DIMENSIONS in inches (millimeters)

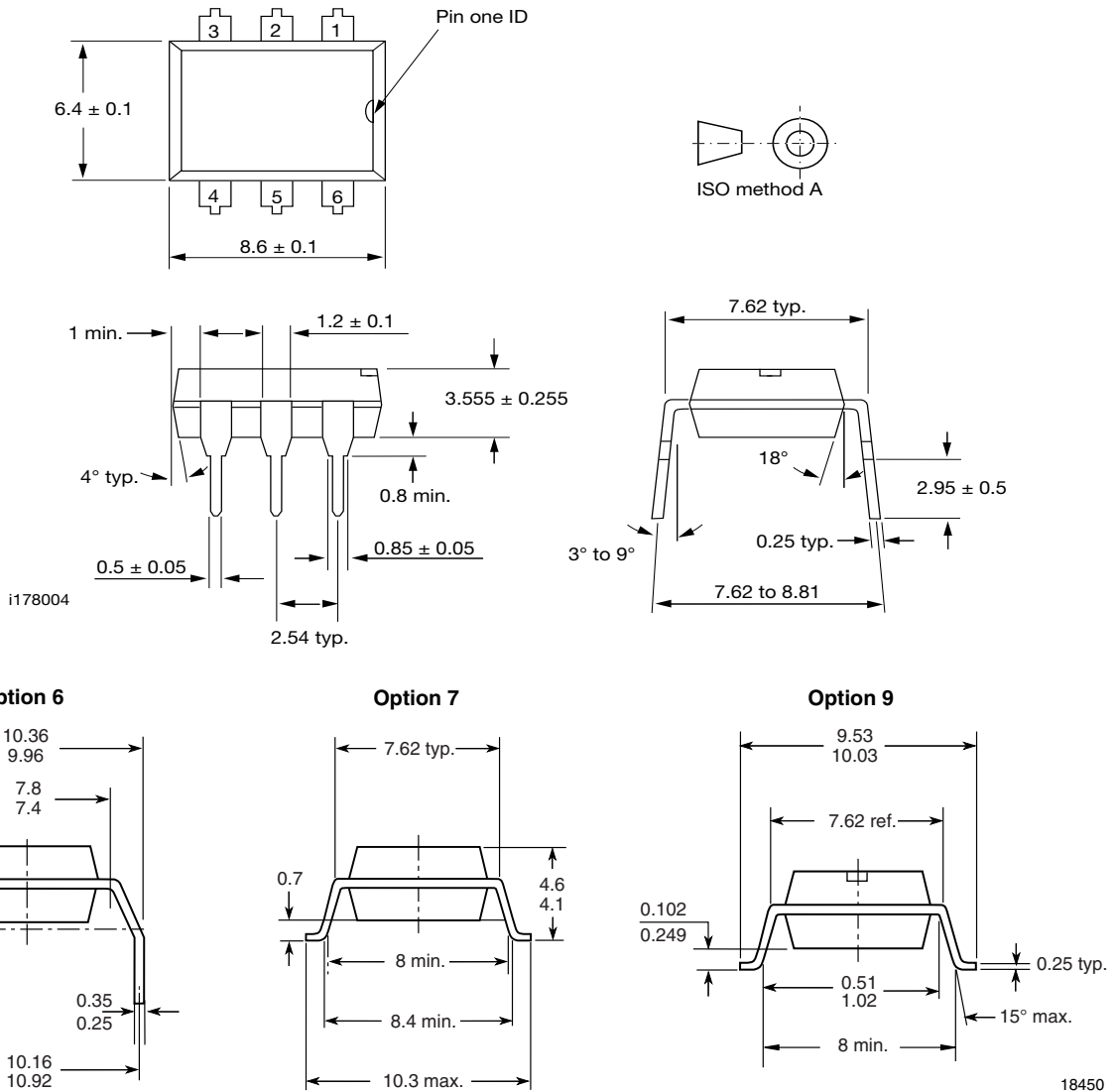

PACKAGE MARKING (example)

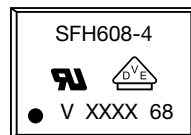

Fig. 13 - Example of SFH608-4X001

Notes

- XXXX = LMC (lot marking code)
- VDE logo is only marked on option 1 parts
- Tape and reel suffix (T) is not part of the package marking



DIP-6A

PACKAGE DIMENSIONS in inches (millimeters)

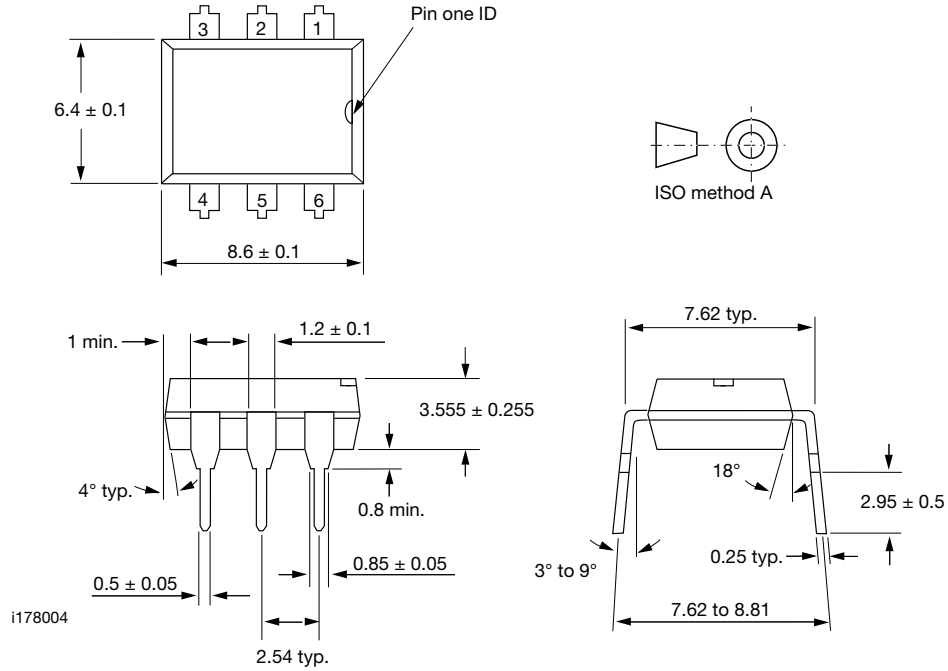

Note

The information in this document provides generic information but for specific information on a product the appropriate product datasheet should be used.



Disclaimer

ALL PRODUCT, PRODUCT SPECIFICATIONS AND DATA ARE SUBJECT TO CHANGE WITHOUT NOTICE TO IMPROVE RELIABILITY, FUNCTION OR DESIGN OR OTHERWISE.

Vishay Intertechnology, Inc., its affiliates, agents, and employees, and all persons acting on its or their behalf (collectively, "Vishay"), disclaim any and all liability for any errors, inaccuracies or incompleteness contained in any datasheet or in any other disclosure relating to any product.

Vishay makes no warranty, representation or guarantee regarding the suitability of the products for any particular purpose or the continuing production of any product. To the maximum extent permitted by applicable law, Vishay disclaims (i) any and all liability arising out of the application or use of any product, (ii) any and all liability, including without limitation special, consequential or incidental damages, and (iii) any and all implied warranties, including warranties of fitness for particular purpose, non-infringement and merchantability.

Statements regarding the suitability of products for certain types of applications are based on Vishay's knowledge of typical requirements that are often placed on Vishay products in generic applications. Such statements are not binding statements about the suitability of products for a particular application. It is the customer's responsibility to validate that a particular product with the properties described in the product specification is suitable for use in a particular application. Parameters provided in datasheets and / or specifications may vary in different applications and performance may vary over time. All operating parameters, including typical parameters, must be validated for each customer application by the customer's technical experts. Product specifications do not expand or otherwise modify Vishay's terms and conditions of purchase, including but not limited to the warranty expressed therein.

Hyperlinks included in this datasheet may direct users to third-party websites. These links are provided as a convenience and for informational purposes only. Inclusion of these hyperlinks does not constitute an endorsement or an approval by Vishay of any of the products, services or opinions of the corporation, organization or individual associated with the third-party website. Vishay disclaims any and all liability and bears no responsibility for the accuracy, legality or content of the third-party website or for that of subsequent links.

Except as expressly indicated in writing, Vishay products are not designed for use in medical, life-saving, or life-sustaining applications or for any other application in which the failure of the Vishay product could result in personal injury or death. Customers using or selling Vishay products not expressly indicated for use in such applications do so at their own risk. Please contact authorized Vishay personnel to obtain written terms and conditions regarding products designed for such applications.

No license, express or implied, by estoppel or otherwise, to any intellectual property rights is granted by this document or by any conduct of Vishay. Product names and markings noted herein may be trademarks of their respective owners.