

New Generation of WICOP

**High-Power LED – WICOP Z8 Y50**  
**SZ8-Y50-XX-XX-XX (Cool, Neutral, Warm)**

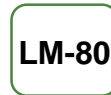
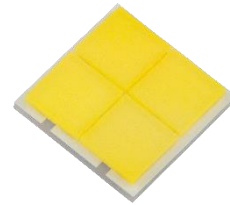

## Product Brief

### Description

- The WICOP series is designed for high flux output applications with high current operation capability.
- It incorporates state of the art SMD design and low thermal resistant material.
- The WICOP is ideal light sources for directional lighting applications such as Spot Lights, various outdoor applications and high performance torches .

### Features and Benefits

Designed for high current operation  
 Low Thermal Resistance  
 A wide CCT range of 2,600~7,000K  
 MacAdam 4 & 5 step ellipse color Binning  
 RoHS compliant  
 Phosphor film directly attached to chip surface

### Key Applications

Residential - Replacement lamps  
 Commercial/Industrial – Retail Display  
 Outdoor area - Flood/Street light, High Bay

**Table 1. Product Selection Table**

Reference Code	Color	Nominal CCT	Part Number	CRI	
				Min	
SZ8-Y50-W0-C7-P	Cool White	6500K	S1W0-5050657012-00000000-PS001	70	
		5700K	S1W0-5050577012-00000000-PS001		
		5000K	S1W0-5050507012-00000000-PS001		
SZ8-Y50-WN-C7-P	Neutral White	4000K	S1W0-5050407012-00000000-PS001		
		Warm White	3500K		S1W0-5050357012-00000000-PS001
			3000K		S1W0-5050307012-00000000-PS001
2700K	S1W0-5050277012-00000000-PS001				
SZ8-Y50-WN-C8-P	Neutral White	4000K	S1W0-5050408012-00000000-PS001		80
SZ8-Y50-WW-C8-P	Warm White	3500K	S1W0-5050358012-00000000-PS001		
		3000K	S1W0-5050308012-00000000-PS001		
		2700K	S1W0-5050278012-00000000-PS001		

# Table of Contents

<b>Index</b>	
• Product Brief	1
• Table of Contents	2
• Performance Characteristics	3
• Characteristics Graph	5
• Color bin structure	10
• Mechanical Dimensions	15
• Recommended Solder Pad	16
• Material Structure	17
• Reflow Soldering Characteristics	18
• Emitter Tape & Reel Packaging	19
• Product Nomenclature	21
• Handling of Silicone Resin for LED	22
• Precaution For Use	23
• Company Information	26

## Performance Characteristics

**Table 2. Electro Optical Characteristics,  $I_F = 700\text{mA}$ ,  $T_j=85^\circ\text{C}$** 

Min. CRI, $R_a^{[4]}$	Nominal CCT [K] <sup>[1]</sup>	Min. Flux [lm]	Typ. Luminous Flux $\Phi_v$ [lm] <sup>[3]</sup>			Typ. Luminous Efficacy [lm/W] @700mA	Part Number
			700mA	1000mA	1500mA		
70	6500	1120	1180	1534	2006	151	S1W0-5050657012-00000000-PS001
	5700	1120	1220	1586	2074	156	S1W0-5050577012-00000000-PS001
	5000	1120	1260	1638	2142	161	S1W0-5050507012-00000000-PS001
	4000	1040	1240	1612	2108	158	S1W0-5050407012-00000000-PS001
	3500	1040	1150	1495	2542	147	S1W0-5050357012-00000000-PS001
	3000	1040	1120	1456	1904	143	S1W0-5050307012-00000000-PS001
	2700	1040	1090	1417	1853	139	S1W0-5050277012-00000000-PS001
80	4000	970	1060	1378	1802	135	S1W0-5050408012-00000000-PS001
	3500	970	1020	1326	1734	130	S1W0-5050358012-00000000-PS001
	3000	900	990	1287	1683	126	S1W0-5050308012-00000000-PS001
	2700	900	950	1235	1615	121	S1W0-5050278012-00000000-PS001

**Note :**

(1) Correlated Color Temperature is derived from the CIE 1931 Chromaticity diagram.

Color coordinate :  $\pm 0.005$ , CCT  $\pm 5\%$  tolerance.

(2) Seoul Semiconductor maintains a tolerance of  $\pm 7\%$  on flux and power measurements.

(3)  $\Phi_v$  is the total luminous flux output as measured with an integrating sphere.

(4) Tolerance is  $\pm 2.0$  on CRI measurements.

## Performance Characteristics

**Table 3. Absolute Maximum Ratings**

Parameter	Symbol	Value			Unit
		Min.	Typ.	Max.	
Forward Current <sup>[1]</sup>	$I_F$	-	0.7	1.5	A
Power Dissipation	$P_D$	-	-	18	W
Junction Temperature	$T_j$	-	-	145	°C
Storage Temperature	$T_{stg}$	- 40	-	125	°C
Viewing angle	$\theta$		125		degree
Forward voltage (700mA, 85°C)	$V_F$		11.0	11.5	V
Thermal resistance (J to S) <sup>[2]</sup>	$R\theta_{J-S}$	-	0.8 <sup>[3]</sup>	-	K/W
ESD Sensitivity(HBM)		Class 2 JEDEC JS-001-2017			

**Note :**

(1) At Junction Temperature 85°C condition.

(2)  $R\theta_{J-S}$  is tested at 700mA.

(3) Using Metal PCB (Normal type).

- Thermal resistance can be increased substantially depending on the heat sink design/operating condition, and the maximum possible driving current will decrease accordingly.

# Characteristics Graph

## Color Spectrum

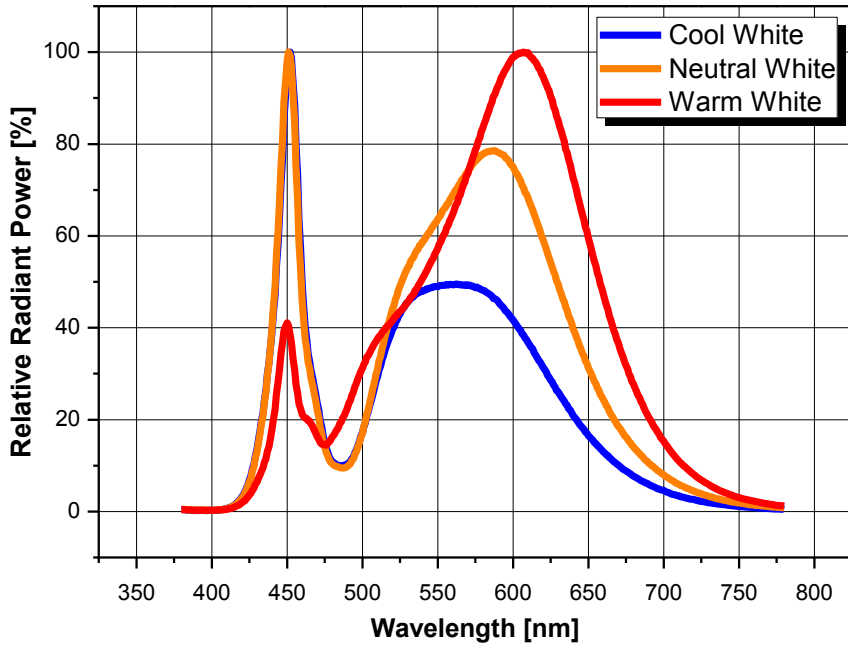

(Fig 1)

## Typical Spatial Distribution

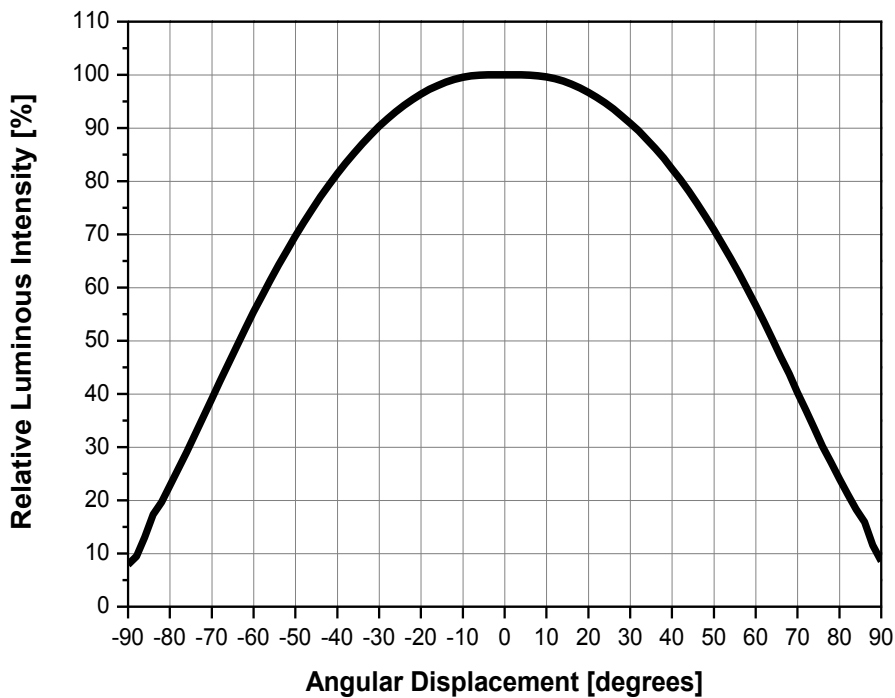

(Fig 2)

## Characteristics Graph

Forward Voltage vs. Forward Current,  $T_j=85^\circ\text{C}$

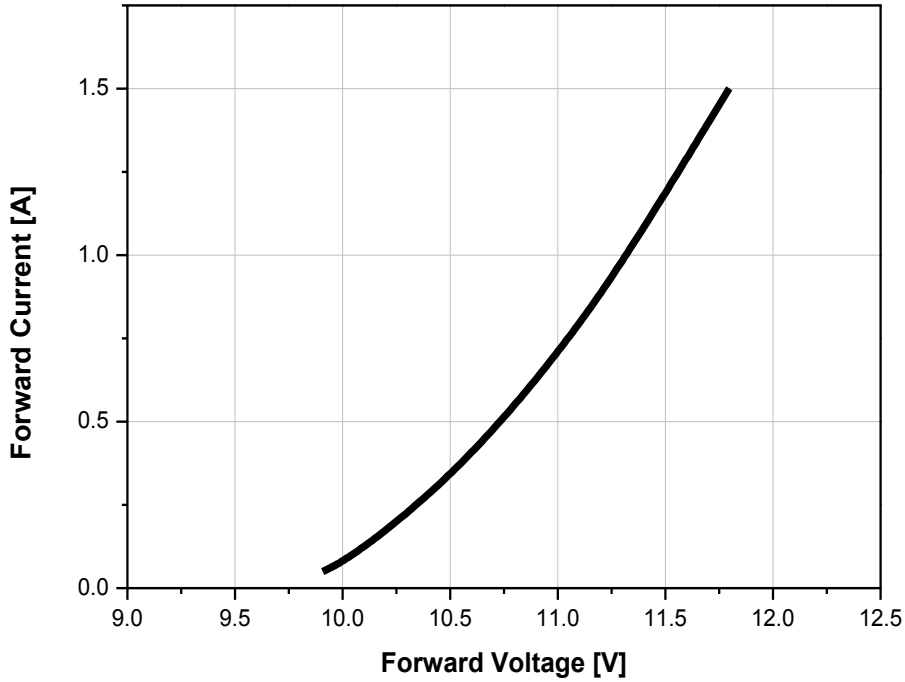

(Fig 3)

Forward Current vs. Relative Luminous Flux,  $T_j=85^\circ\text{C}$

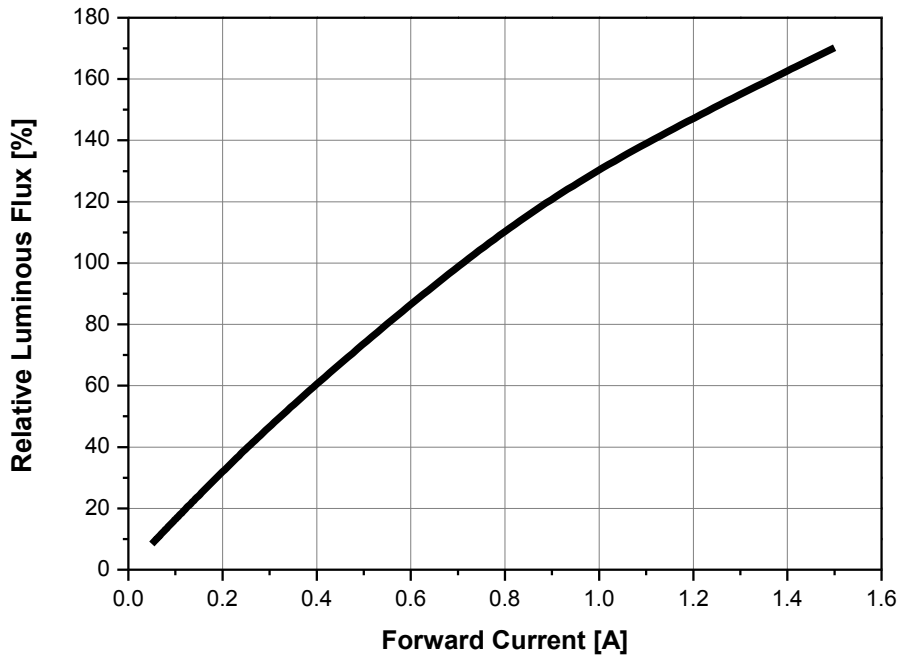

(Fig 4)

## Characteristics Graph

Forward Current vs. CIE X, Y Shift,  $T_j=85^\circ\text{C}$

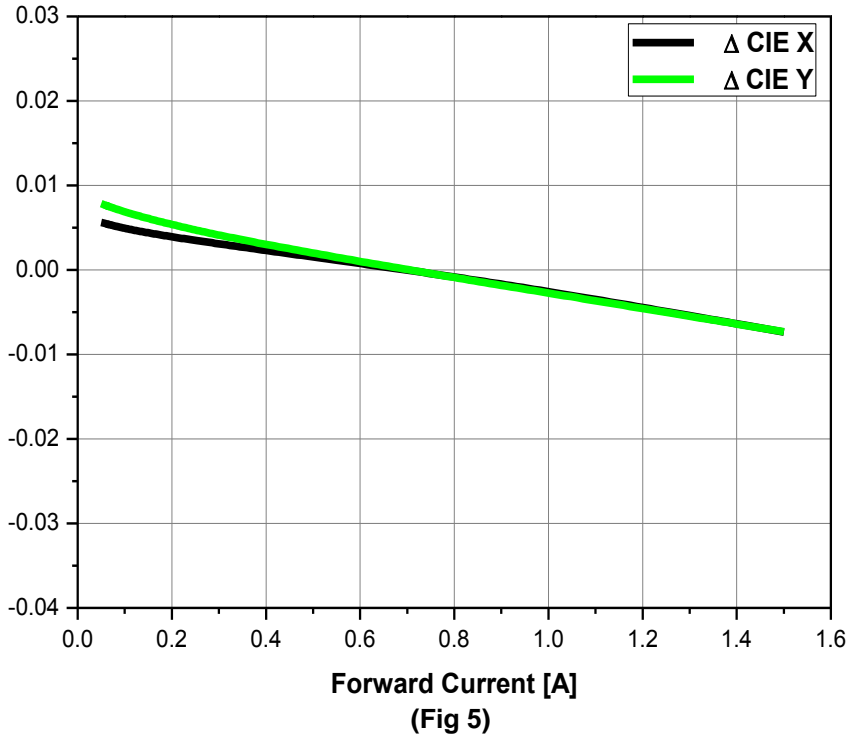

Junction Temp. vs. CIE X, Y Shift,  $I_f=700\text{mA}$

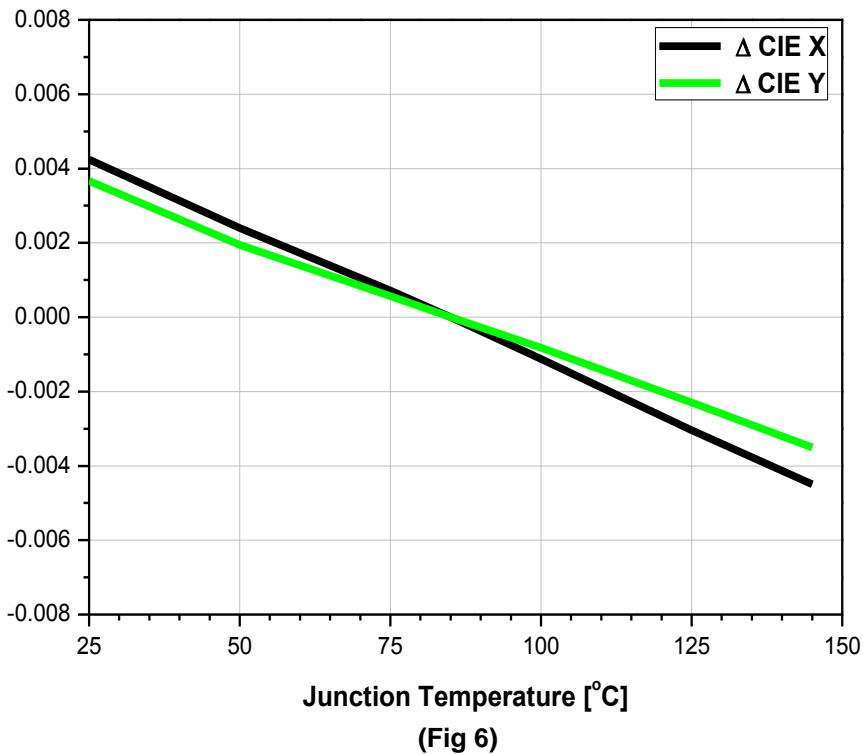

## Characteristics Graph

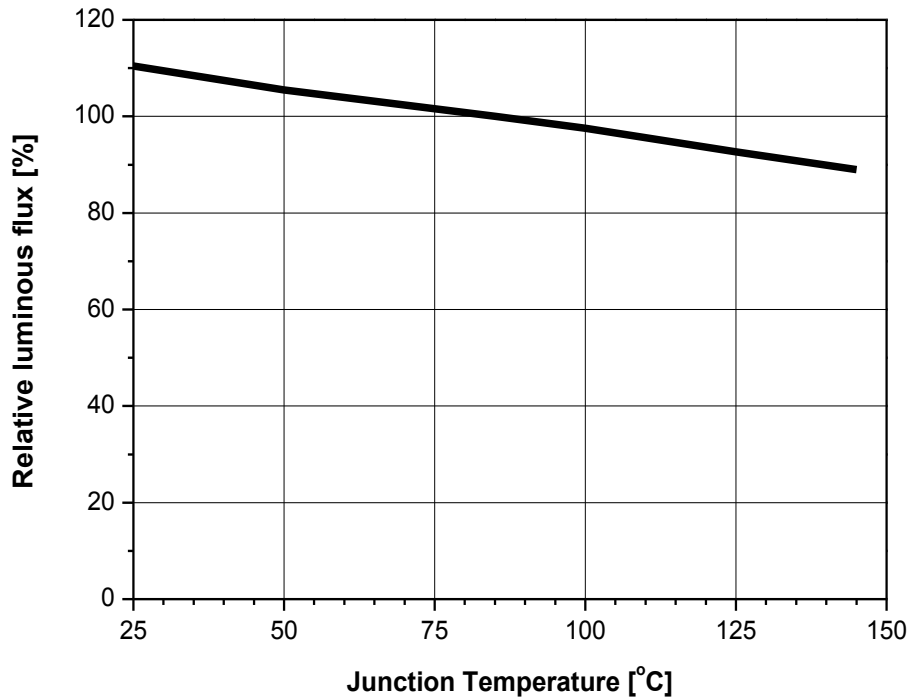
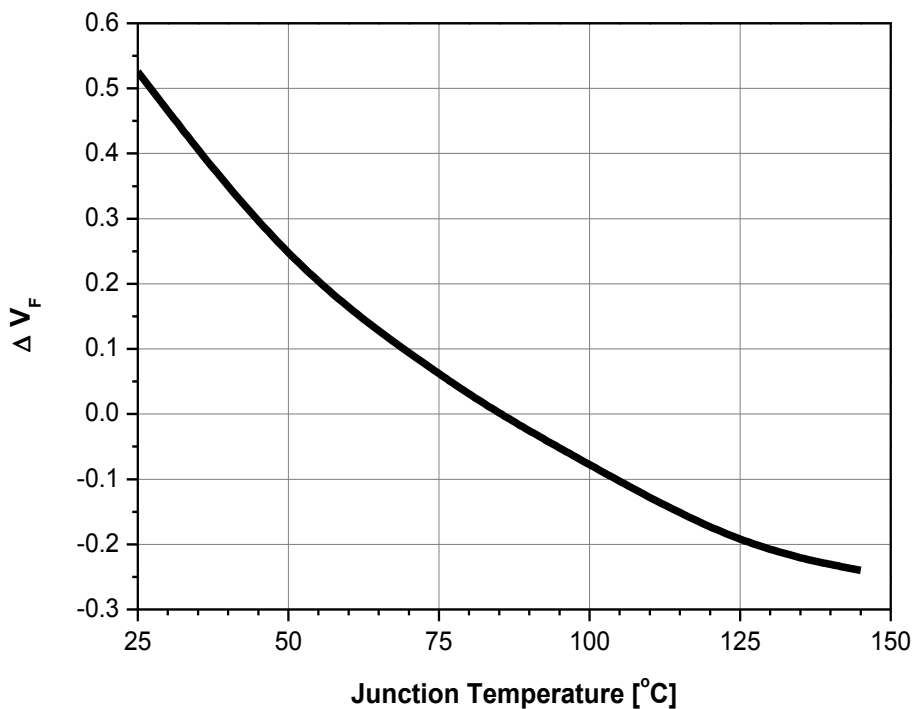
**Junction Temp. vs. Relative Luminous Flux,  $I_F=700\text{mA}$** 

**(Fig 7)**
**Junction Temp. vs. Relative Forward Voltage,  $I_F=700\text{mA}$** 

**(Fig 8)**

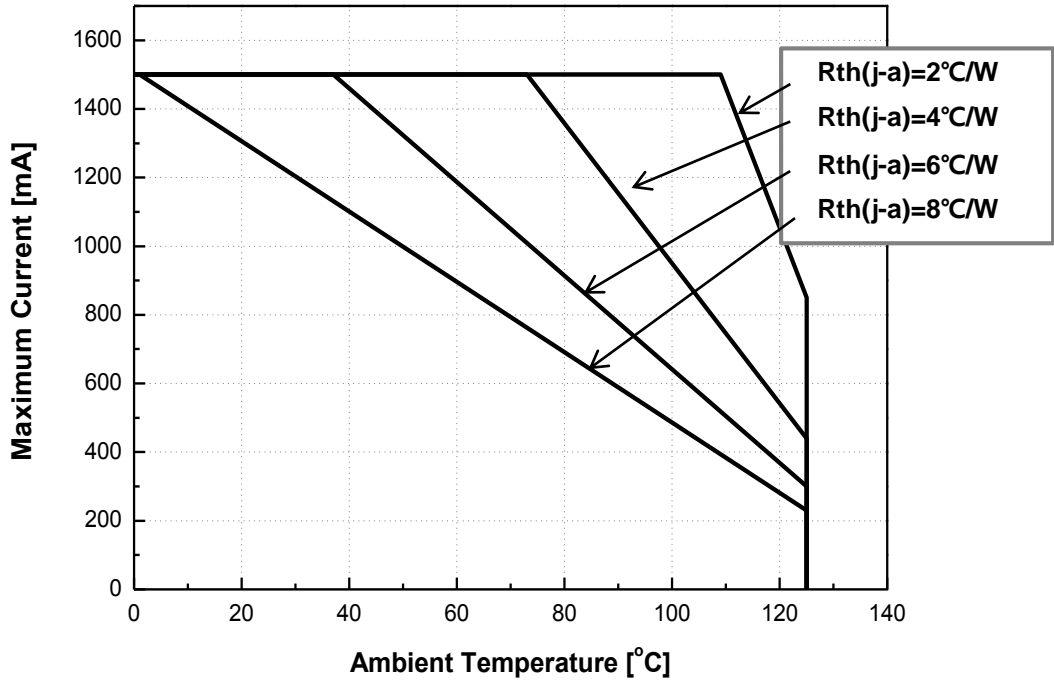

## Characteristics Graph

Ambient Temp. vs. Maximum Forward Current,  $T_j(\text{max.})=145^\circ\text{C}$ ,  $I_F=1.5\text{A}$



(Fig 9)

## Color Bin Structure

**Table 4. Bin Code description,  $I_f=700\text{mA}$ ,  $T_j=85^\circ\text{C}$** 
**<CRI 70>**

Part Number	Luminous Flux [lm]			Color Chromaticity Coordinate	Typical Forward Voltage [ $V_f$ ] <sup>[1]</sup>		
	Bin Code	Min.	Max.		Bin Code	Min.	Max.
S1W0-5050xx7012-00000000-PS001	H	1290	1380	Refer to page. 12~14	F	10.5	10.8
	G	1200	1290		G	10.8	11.2
	F	1120	1200		H	11.2	11.5
	E	1040	1120				

**Table 5. Luminous Flux rank distribution(CRI70)**

Available Rank

CCT	CIE	Luminous Flux Rank					
6,000 ~ 7,000K	A	C	D	E	F	G	H
5,300 ~ 6,000K	B	C	D	E	F	G	H
4,700 ~ 5,300K	C	C	D	E	F	G	H
3,700 ~ 4,200K	E	C	D	E	F	G	H
3,200 ~ 3,700K	F	C	D	E	F	G	H
2,900 ~ 3,200K	G	C	D	E	F	G	H
2,600 ~ 2,900K	H	C	D	E	F	G	H

**Notes :**

(1) Tolerance is  $\pm 0.06\text{V}$  on forward voltage measurements.

## Color Bin Structure

**Table 4. Bin Code description,  $I_F=700\text{mA}$ ,  $T_j=85^\circ\text{C}$** 
**<CRI 80>**

Part Number	Luminous Flux [lm]			Color Chromaticity Coordinate	Typical Forward Voltage [ $V_F$ ] <sup>[1]</sup>		
	Bin Code	Min.	Max.		Bin Code	Min.	Max.
S1W0-5050xx8012-00000000-PS001	E	1040	1120	Refer to page. 12~14	F	10.5	10.8
	D	970	1040		G	10.8	11.2
	C	900	970		H	11.2	11.5

**Table 5. Luminous Flux rank distribution(CRI80)**

Available Rank

CCT	CIE	Luminous Flux Rank					
3,700 ~ 4,200K	E	B	C	D	E	F	G
3,200 ~ 3,700K	F	B	C	D	E	F	G
2,900 ~ 3,200K	G	B	C	D	E	F	G
2,600 ~ 2,900K	H	B	C	D	E	F	G

**Notes :**

 (1) Tolerance is  $\pm 0.06\text{V}$  on forward voltage measurements.

## Color Bin Structure

CIE Chromaticity Diagram,  $T_j=85^\circ\text{C}$ ,  $I_f=700\text{mA}$

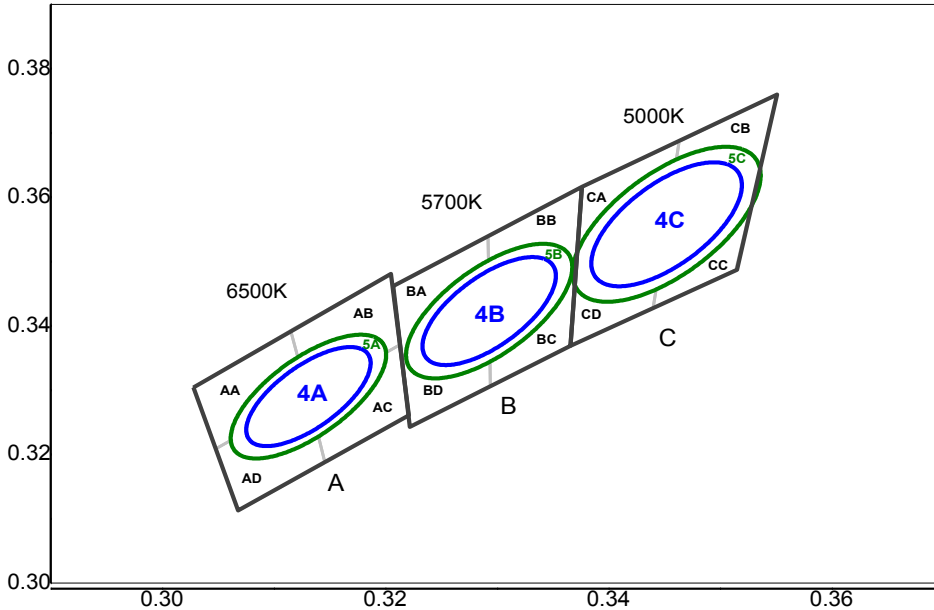

6500K 4Step		5700K 4Step		5000K 4Step	
4A		4B		4C	
Center point	0.3123 : 0.3282	Center point	0.3287 : 0.3417	Center point	0.3447 : 0.3553
Major Axis a	0.0088	Major Axis a	0.0095	Major Axis a	0.0108
Minor Axis b	0.0036	Minor Axis b	0.0040	Minor Axis b	0.0047
Ellipse Rotation Angle	58	Ellipse Rotation Angle	59	Ellipse Rotation Angle	60

6500K 5Step		5700K 5Step		5000K 5Step	
5A		5B		5C	
Center point	0.3123 : 0.3282	Center point	0.3287 : 0.3417	Center point	0.3447 : 0.3553
Major Axis a	0.0110	Major Axis a	0.0118	Major Axis a	0.0135
Minor Axis b	0.0045	Minor Axis b	0.0050	Minor Axis b	0.0058
Ellipse Rotation Angle	58	Ellipse Rotation Angle	59	Ellipse Rotation Angle	60

AA		AB		AC		AD	
CIE X	CIE Y	CIE X	CIE Y	CIE X	CIE Y	CIE X	CIE Y
0.3028	0.3304	0.3115	0.3393	0.3131	0.329	0.3048	0.3209
0.3048	0.3209	0.3131	0.329	0.3146	0.3187	0.3068	0.3113
0.3131	0.329	0.3213	0.3371	0.3221	0.3261	0.3146	0.3187
0.3115	0.3393	0.3205	0.3481	0.3213	0.3371	0.3131	0.329
BA		BB		BC		BD	
CIE X	CIE Y	CIE X	CIE Y	CIE X	CIE Y	CIE X	CIE Y
0.3207	0.3462	0.3292	0.3539	0.3293	0.3423	0.3215	0.3353
0.3215	0.3353	0.3293	0.3423	0.3294	0.3306	0.3222	0.3243
0.3293	0.3423	0.3371	0.3493	0.3366	0.3369	0.3294	0.3306
0.3292	0.3539	0.3376	0.3616	0.3371	0.3493	0.3293	0.3423
CA		CB		CC		CD	
CIE X	CIE Y	CIE X	CIE Y	CIE X	CIE Y	CIE X	CIE Y
0.3376	0.3616	0.3463	0.3687	0.3452	0.3558	0.3371	0.3493
0.3371	0.3493	0.3452	0.3558	0.344	0.3428	0.3366	0.3369
0.3452	0.3558	0.3533	0.3624	0.3514	0.3487	0.344	0.3428
0.3463	0.3687	0.3551	0.376	0.3533	0.3624	0.3452	0.3558

## Color Bin Structure

CIE Chromaticity Diagram,  $T_j=85^\circ\text{C}$ ,  $I_f=700\text{mA}$

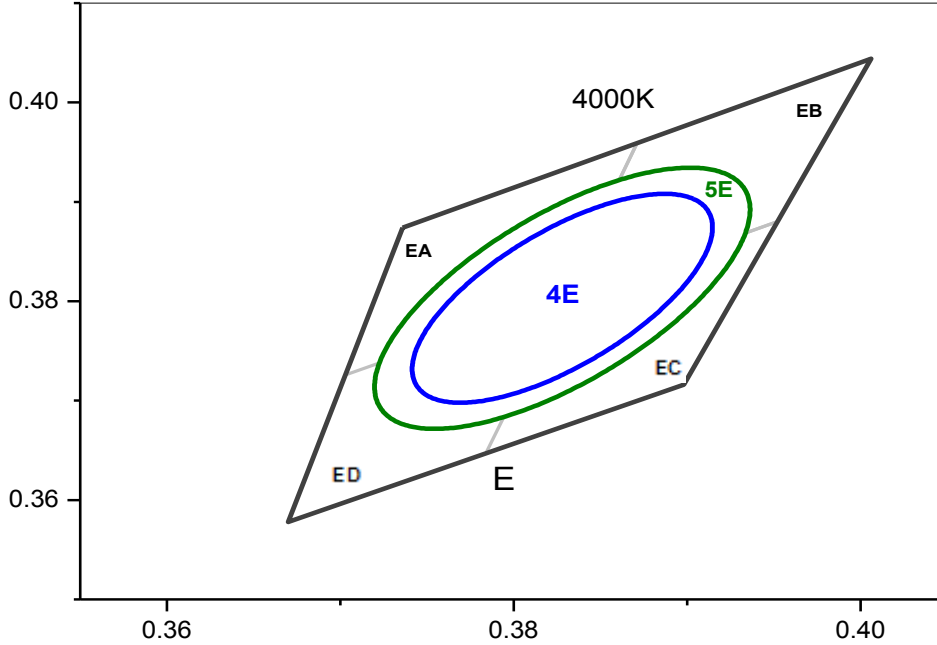

### 4000K 4Step

4E	
Center point	0.3818 : 0.3797
Major Axis a	0.0125
Minor Axis b	0.0053
Ellipse Rotation Angle	53

### 4000K 5Step

5E	
Center point	0.3818 : 0.3797
Major Axis a	0.0157
Minor Axis b	0.0067
Ellipse Rotation Angle	53

EA		EB		EC		ED	
CIE X	CIE Y	CIE X	CIE Y	CIE X	CIE Y	CIE X	CIE Y
0.3736	0.3874	0.3871	0.3959	0.3828	0.3803	0.3703	0.3726
0.3703	0.3726	0.3828	0.3803	0.3784	0.3647	0.367	0.3578
0.3828	0.3803	0.3952	0.388	0.3898	0.3716	0.3784	0.3647
0.3871	0.3959	0.4006	0.4044	0.3952	0.388	0.3828	0.3803

## Color Bin Structure

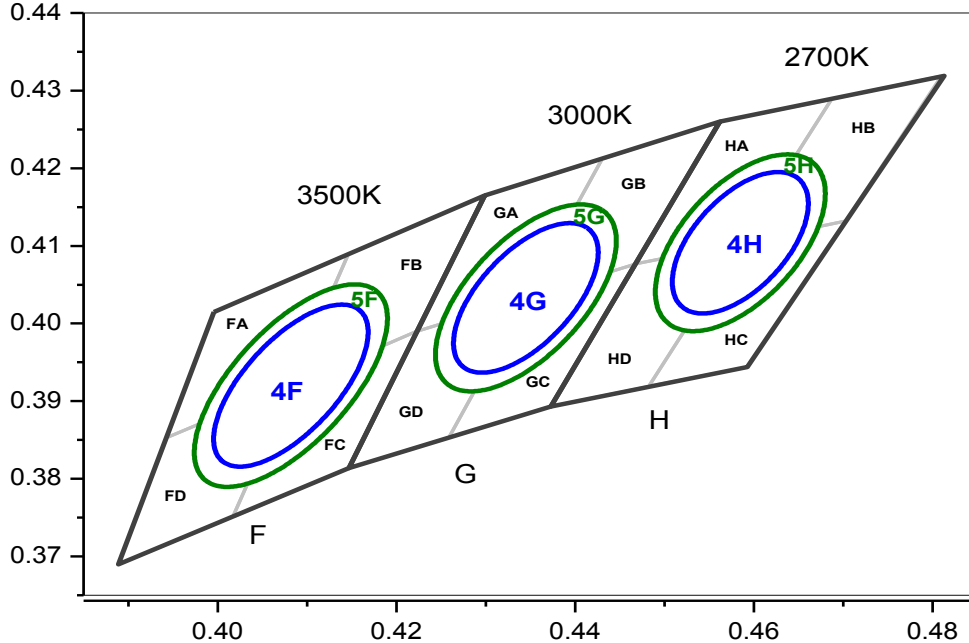
**CIE Chromaticity Diagram,  $T_j=85^\circ\text{C}$ ,  $I_f=700\text{mA}$** 

3500K 4Step		3000K 4Step		2700K 4Step	
4F		4G		4H	
Center point	0.4073 : 0.3917	Center point	0.4338 : 0.4030	Center point	0.4578 : 0.4101
Major Axis a	0.0124	Major Axis a	0.0113	Major Axis a	0.0105
Minor Axis b	0.0055	Minor Axis b	0.0055	Minor Axis b	0.0055
Ellipse Rotation Angle	53	Ellipse Rotation Angle	53	Ellipse Rotation Angle	54

3500K 5Step		3000K 5Step		2700K 5Step	
5F		5G		5H	
Center point	0.4073 : 0.3917	Center point	0.4338 : 0.4030	Center point	0.4578 : 0.4101
Major Axis a	0.0155	Major Axis a	0.0142	Major Axis a	0.0132
Minor Axis b	0.0068	Minor Axis b	0.0068	Minor Axis b	0.0068
Ellipse Rotation Angle	53	Ellipse Rotation Angle	53	Ellipse Rotation Angle	54

FA		FB		FC		FD	
CIE X	CIE Y	CIE X	CIE Y	CIE X	CIE Y	CIE X	CIE Y
0.3996	0.4015	0.4146	0.4089	0.4082	0.392	0.3943	0.3853
0.3943	0.3853	0.4082	0.392	0.4017	0.3751	0.3889	0.369
0.4082	0.392	0.4223	0.399	0.4147	0.3814	0.4017	0.3751
0.4146	0.4089	0.4299	0.4165	0.4223	0.399	0.4082	0.392
GA		GB		GC		GD	
CIE X	CIE Y	CIE X	CIE Y	CIE X	CIE Y	CIE X	CIE Y
0.4299	0.4165	0.443	0.4212	0.4345	0.4033	0.4223	0.399
0.4223	0.399	0.4345	0.4033	0.4259	0.3853	0.4147	0.3814
0.4345	0.4033	0.4468	0.4077	0.4373	0.3893	0.4259	0.3853
0.443	0.4212	0.4562	0.426	0.4468	0.4077	0.4345	0.4033
HA		HB		HC		HD	
CIE X	CIE Y	CIE X	CIE Y	CIE X	CIE Y	CIE X	CIE Y
0.4562	0.426	0.4687	0.4289	0.4585	0.4104	0.4468	0.4077
0.4468	0.4077	0.4585	0.4104	0.4483	0.3919	0.4373	0.3893
0.4585	0.4104	0.4703	0.4132	0.4593	0.3944	0.4483	0.3919
0.4687	0.4289	0.481	0.4319	0.4703	0.4132	0.4585	0.4104

## Mechanical Dimensions

SZ8-Y50-XX-XX-XX

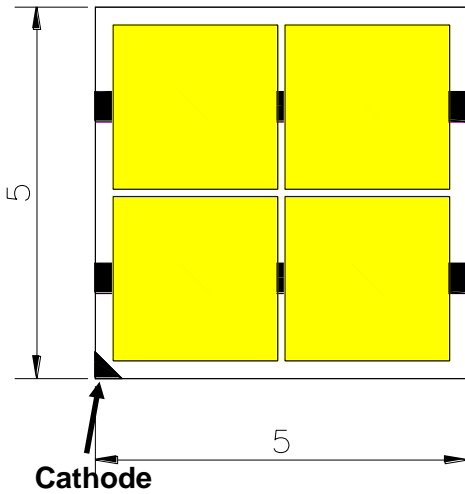

< Top >

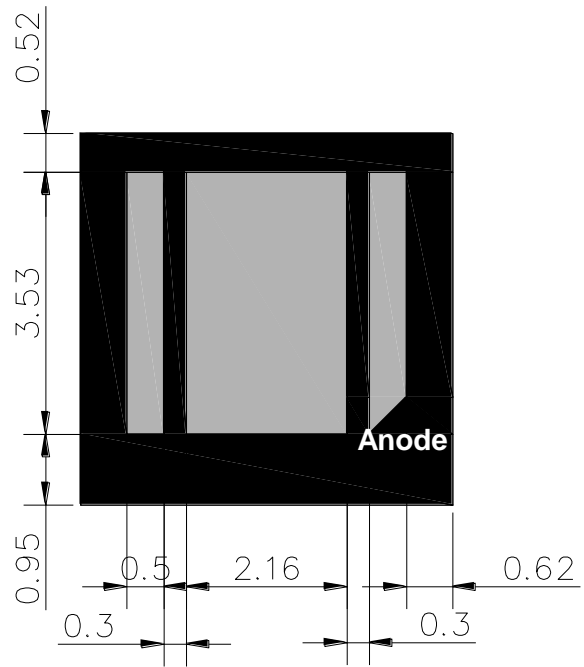

< Bottom >

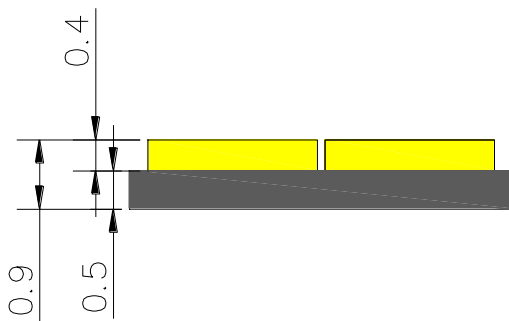

< Side >

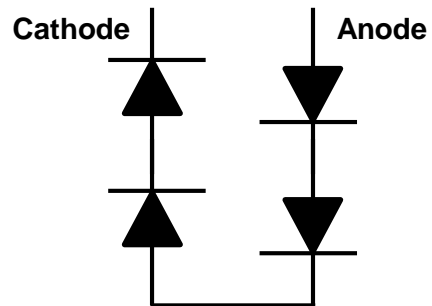

< Inner circuit >

- (1) All dimensions are in millimeters.
- (2) Scale : none
- (3) Undefined tolerance is  $\pm 0.2\text{mm}$

## Recommended Solder Pad

SZ8-Y50-XX-XX-XX

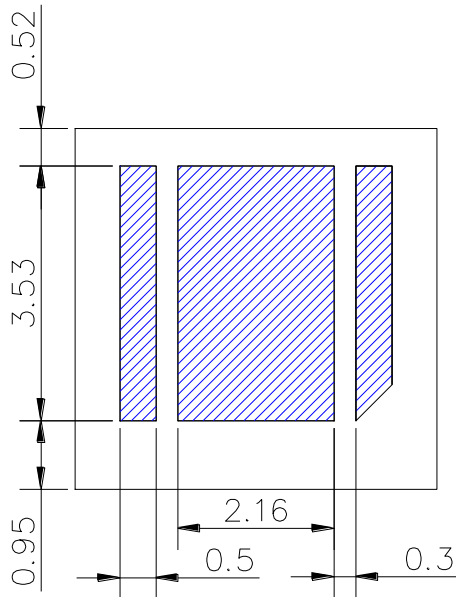

**< Solder Pad >**

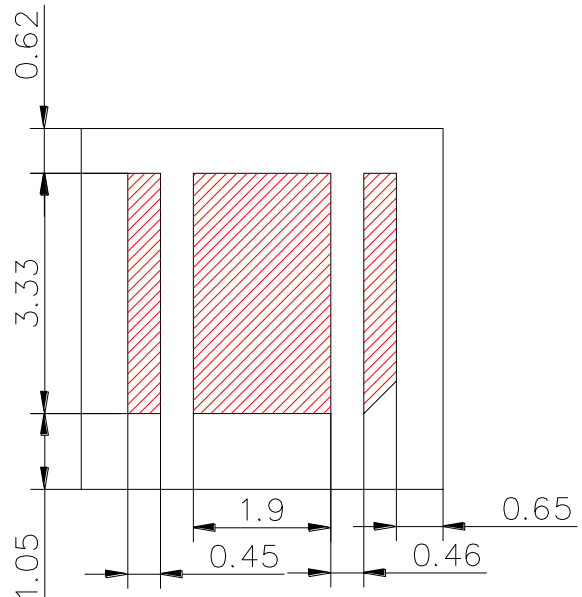

**< Mask Stencil >**

- (1) All dimensions are in millimeters.
- (2) Scale : none
- (3) This drawing without tolerances are for reference only.
- (4) Undefined tolerance is  $\pm 0.1\text{mm}$ .



## Material Structure

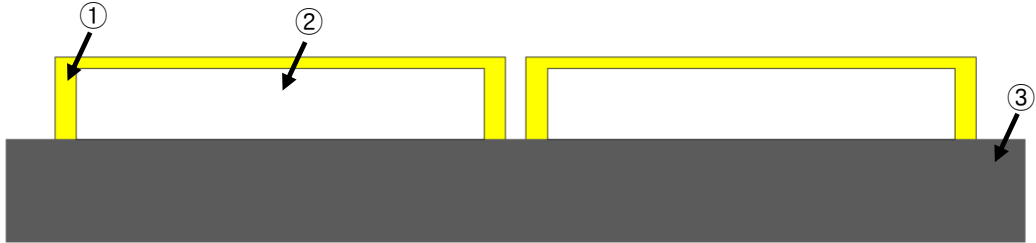

No.	List	Material
①	Encapsulation	Silicone, Phosphor
②	Chip Source	GaN ON SAPPHIRE
③	Substrate	Ceramic (AlN)

## Reflow Soldering Characteristics

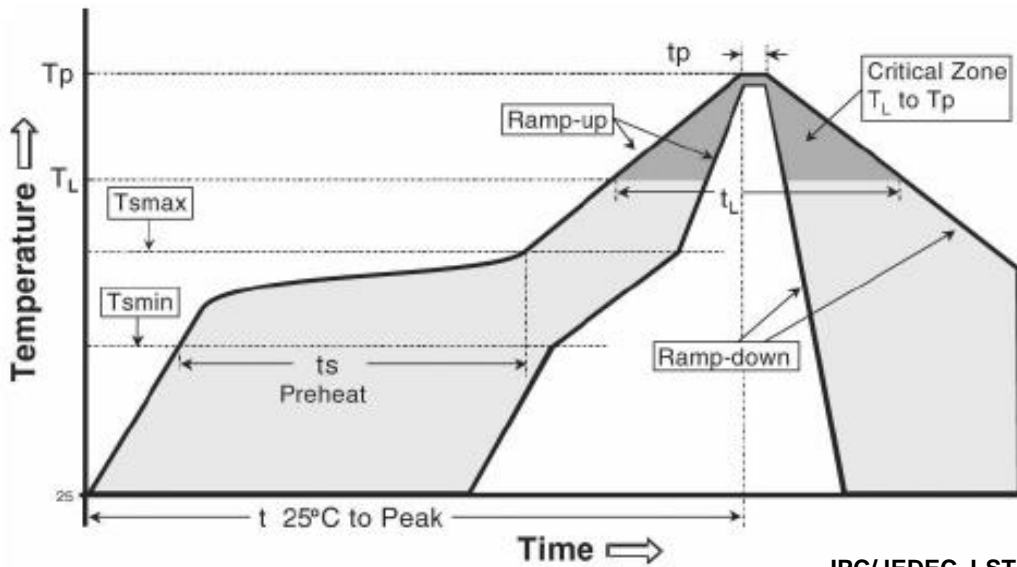
**IPC/JEDEC J-STD-020**

Profile Feature	Pb-Free Assembly
Average ramp-up rate (T <sub>smax</sub> to T <sub>p</sub> )	3° C/second max.
Preheat - Temperature Min (T <sub>smin</sub> ) - Temperature Max (T <sub>smax</sub> ) - Time (T <sub>smin</sub> to T <sub>smax</sub> ) (t <sub>s</sub> )	150 °C 180 °C 80-120 seconds
Time maintained above: - Temperature (T <sub>L</sub> ) - Time (t <sub>L</sub> )	217~220°C 80-100 seconds
Peak Temperature (T <sub>p</sub> )	250~255°C
Time within 5°C of actual Peak Temperature (t <sub>p</sub> ) <sub>2</sub>	20-40 seconds
Ramp-down Rate	6 °C/second max.
Time 25°C to Peak Temperature	8 minutes max.
Atmosphere	Nitrogen (O <sub>2</sub> <1000ppm)

### Caution

- (1) Reflow soldering is recommended not to be done more than two times. In the case of more than 24 hours passed soldering after first, LED will be damaged.
- (2) Re-soldering should not be done after the LED has been soldered. If re-soldering is unavoidable, LED's characteristics should be carefully checked before and after such repair..
- (3) Do not put stress on the LED during heating.
- (4) After reflow, do not clean PCB by water or solvent.

### SMT recommendation

- (1) After reflow, Over 80% reflectance of PSR is recommended. → Tamura RPW-8000-xx
- (2) Solder paste materials (SAC 305, No Cleaning Paste ) → Senju M705-GRN360-K2-V
- (3) We recommend TOV Test 7.2v~10.8v at 1uA (per LED)
- (4) We recommend IR Test 0~1uA at -5V (per LED)

# Emitter Tape & Reel Packaging

SZ8-Y50-XX-XX-XX

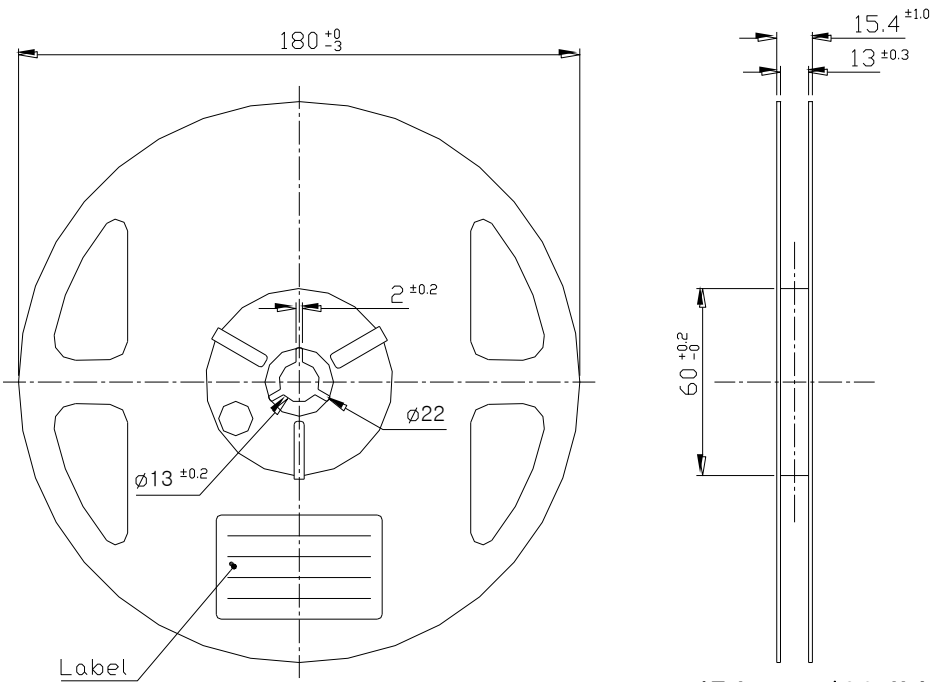
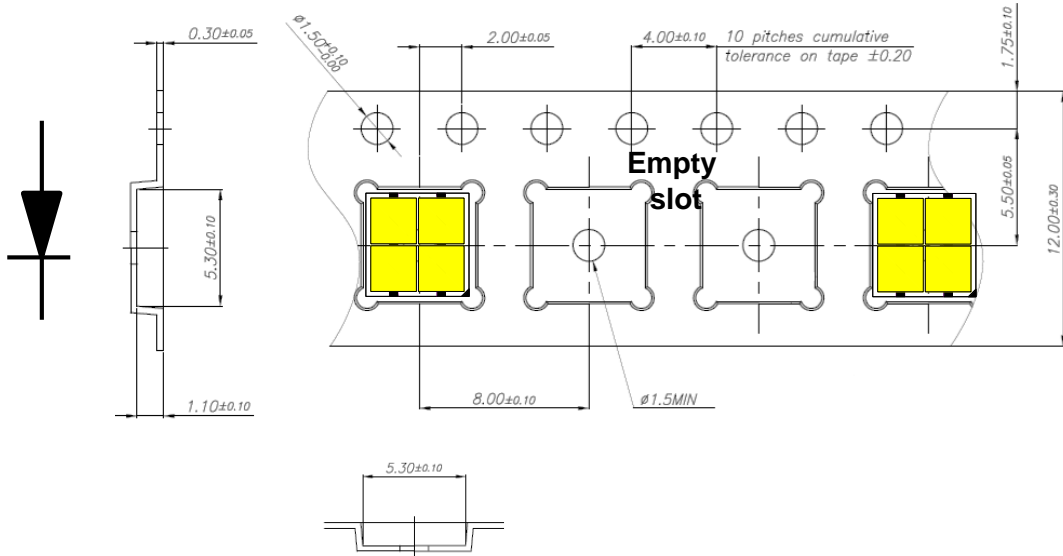

### Notes :

- (1) Quantity : 500pcs/Reel  
(empty slot is possible in taping reel  
Continuous empty slot can be max. 3ea and total empty slot is possible max. 10ea.)
- (2) Cumulative Tolerance : Cumulative Tolerance/10 pitches to be  $\pm 0.2$ mm
- (3) Adhesion Strength of Cover Tape : Adhesion strength to be 0.1-0.7N when the cover tape is turned off from the carrier tape at the angle of  $10^\circ$  to the carrier tape
- (4) Package : P/N, Manufacturing data Code No. and quantity to be indicated on a damp proof Package

## Packaging Information

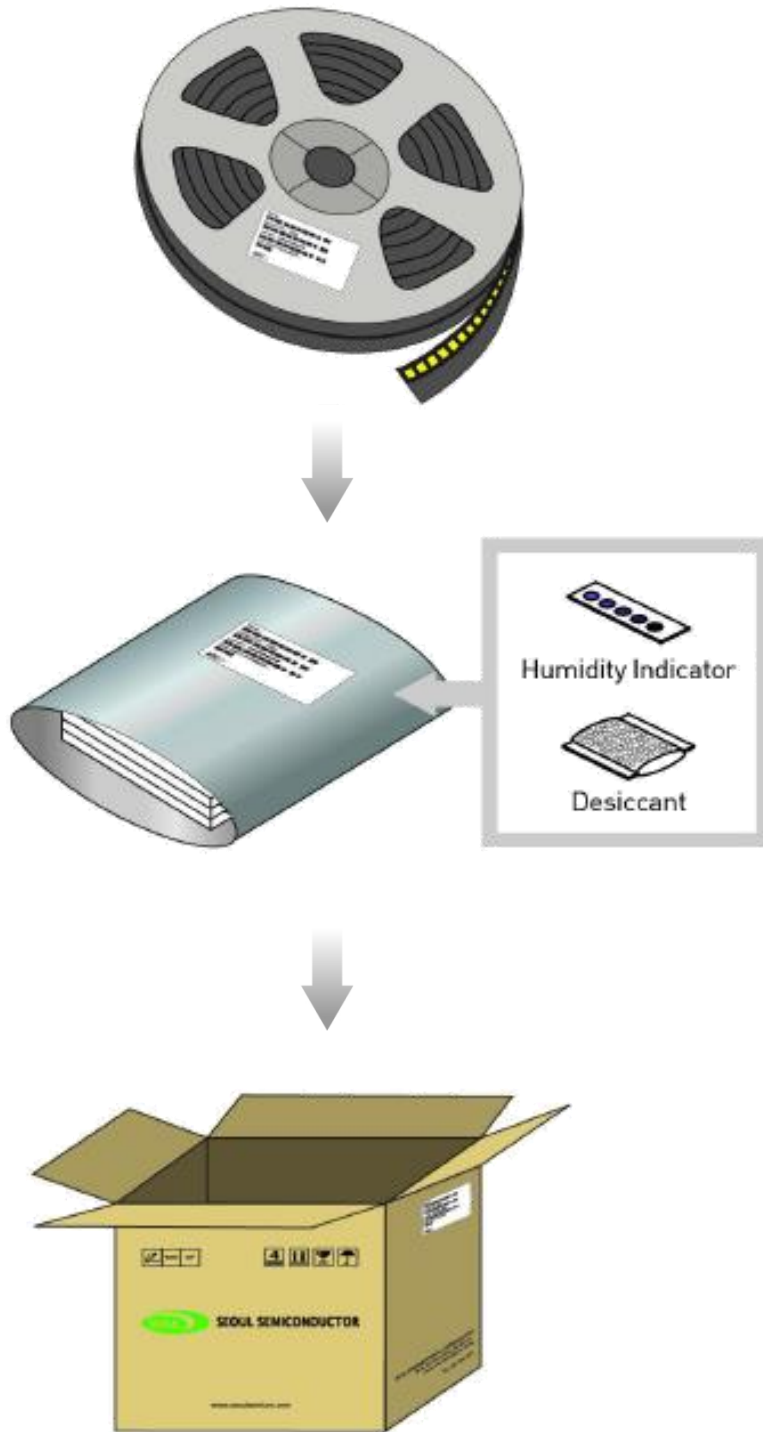

## Product Nomenclature

**Table 6. Part Numbering System : X<sub>1</sub>X<sub>2</sub>X<sub>3</sub>X<sub>4</sub>X<sub>5</sub>X<sub>6</sub>X<sub>7</sub>X<sub>8</sub>-X<sub>9</sub>**

Part Number Code	Description	Part Number	Value
X <sub>1</sub>	Company	S	Seoul Semiconductor
X <sub>2</sub>	Level of Integration	1	Discrete LED
X <sub>3</sub> X <sub>4</sub>	Technology	W0	General White
X <sub>5</sub> X <sub>6</sub> X <sub>7</sub> X <sub>8</sub>	Dimension	5050	
X <sub>9</sub> X <sub>10</sub>	CCT	40	
X <sub>11</sub> X <sub>12</sub>	CRI	70	
X <sub>13</sub> X <sub>14</sub>	Vf	12	
X <sub>15</sub> X <sub>16</sub> X <sub>17</sub>	Characteristic code Flux Rank	000	
X <sub>18</sub> X <sub>19</sub> X <sub>20</sub>	Characteristic code Vf Rank	000	
X <sub>21</sub> X <sub>22</sub>	Characteristic code Color Step	00	
X <sub>23</sub> X <sub>24</sub>	Type	PS	
X <sub>25</sub> X <sub>26</sub> X <sub>27</sub>	Internal code	001	

**Notes :**

- (1) Tolerance is ±0.06V on forward voltage measurements.

## Handling of Silicone Resin for LED

- (1) During processing, mechanical stress on the surface should be minimized as much as possible. Sharp objects of all types should not be used to pierce the sealing compound.



- (2) Do not use tweezers to pick up or handle WICOP LED. A vacuum pick up should only be used.
- (3) When populating boards in SMT production, there are basically no restrictions regarding the form of the pick and place nozzle, except that mechanical pressure on the surface of the resin must be prevented. This is assured by choosing a pick and place nozzle which is smaller than the LED's area.
- (4) Silicone differs from materials conventionally used for the manufacturing of LED. These conditions must be considered during the handling of such devices. Compared to standard encapsulants, silicone is generally softer, and the surface is more likely to attract dust. As mentioned previously, the increased sensitivity to dust requires special care during processing.
- (5) Please do not mold this product into another resin (epoxy, urethane, etc) and do not handle this product with acid or sulfur material in sealed space.
- (6) Avoid leaving fingerprints on silicone resin parts.

## Precaution for Use

### (1) Storage

To avoid the moisture penetration, we recommend storing LED in a dry box with a desiccant . The recommended storage temperature range is 5°C to 30°C and a maximum humidity of RH50%.

### (2) Use Precaution after Opening the Packaging

Use proper SMD techniques when the LED is to be soldered dipped as separation of the lens may affect the light output efficiency.

Pay attention to the following:

a. Recommend conditions after opening the package

- Sealing / Temperature : 5 ~ 30°C Humidity : less than RH60%

b. If the package has been opened more than 1 year (MSL 2) or the color of

the desiccant changes, components should be dried for 10-24hr at 65±5°C

(3) Do not apply mechanical force or excess vibration during the cooling process to normal temperature after soldering.

(4) Do not rapidly cool device after soldering.

(5) Components should not be mounted on warped (non coplanar) portion of PCB.

(6) Radioactive exposure is not considered for the products listed here in.

(7) Gallium arsenide is used in some of the products listed in this publication. These products are dangerous if they are burned or shredded in the process of disposal. It is also dangerous to drink the liquid or inhale the gas generated by such products when chemically disposed of.

(8) This device should not be used in any type of fluid such as water, oil, organic solvent and etc.

(9) When the LED is in operation the maximum current should be decided after measuring the package temperature.

(10) The appearance and specifications of the product may be modified for improvement without notice.

(11) Long time exposure of sunlight or occasional UV exposure will cause lens discoloration.

## Precaution for Use

(12) VOCs (Volatile organic compounds) emitted from materials used in the construction of fixtures can penetrate silicone encapsulants of LED and discolor when exposed to heat and photonic energy. The result can be a significant loss of light output from the fixture. Knowledge of the properties of the materials selected to be used in the construction of fixtures can help prevent these issues.

(13) The slug is electrically isolated.

(14) Attaching LED, do not use adhesives that outgas organic vapor.

(15) The driving circuit must be designed to allow forward voltage only when it is ON or OFF. If the reverse voltage is applied to LED, migration can be generated resulting in LED damage.

(16) LED is sensitive to Electro-Static Discharge (ESD) and Electrical Over Stress (EOS). Below is a list of suggestions that Seoul Semiconductor purposes to minimize these effects.

### a. ESD (Electro Static Discharge)

Electrostatic discharge (ESD) is defined as the release of static electricity when two objects come into contact. While most ESD events are considered harmless, it can be an expensive problem in many industrial environments during production and storage. The damage from ESD to an LED may cause the product to demonstrate unusual characteristics such as:

- Increase in reverse leakage current lowered turn-on voltage
- Abnormal emissions from the LED at low current

The following recommendations are suggested to help minimize the potential for an ESD event. One or more recommended work area suggestions:

- Ionizing fan setup
- ESD table/shelf mat made of conductive materials
- ESD safe storage containers

One or more personnel suggestion options:

- Antistatic wrist-strap
- Antistatic material shoes
- Antistatic clothes

Environmental controls:

- Humidity control (ESD gets worse in a dry environment)





## Company Information

### Published by

Seoul Semiconductor © 2013 All Rights Reserved.

### Company Information

Seoul Semiconductor ([www.SeoulSemicon.com](http://www.SeoulSemicon.com)) manufactures and packages a wide selection of light emitting diodes (LEDs) for the automotive, general illumination/lighting, Home appliance, signage and back lighting markets. The company is the world's fifth largest LED supplier, holding more than 10,000 patents globally, while offering a wide range of LED technology and production capacity in areas such as "nPola", "Acrich", the world's first commercially produced AC LED, and "Acrich MJT - Multi-Junction Technology" a proprietary family of high-voltage LEDs.

The company's broad product portfolio includes a wide array of package and device choices such as Acrich and Acirch2, high-brightness LEDs, mid-power LEDs, side-view LEDs, and through-hole type LEDs as well as custom modules, displays, and sensors.

### Legal Disclaimer

Information in this document is provided in connection with Seoul Semiconductor products. With respect to any examples or hints given herein, any typical values stated herein and/or any information regarding the application of the device, Seoul Semiconductor hereby disclaims any and all warranties and liabilities of any kind, including without limitation, warranties of non-infringement of intellectual property rights of any third party. The appearance and specifications of the product can be changed to improve the quality and/or performance without notice.

## Precaution for Use

### b. EOS (Electrical Over Stress)

Electrical Over-Stress (EOS) is defined as damage that may occur when an electronic device is subjected to a current or voltage that is beyond the maximum specification limits of the device. The effects from an EOS event can be noticed through product performance like:

- Changes to the performance of the LED package  
(If the damage is around the bond pad area and since the package is completely encapsulated the package may turn on but flicker show severe performance degradation.)
- Changes to the light output of the luminaire from component failure
- Components on the board not operating at determined drive power

Failure of performance from entire fixture due to changes in circuit voltage and current across total circuit causing trickle down failures. It is impossible to predict the failure mode of every LED exposed to electrical overstress as the failure modes have been investigated to vary, but there are some common signs that will indicate an EOS event has occurred:

- This damage usually appears due to the thermal stress produced during the EOS event.

### c. To help minimize the damage from an EOS event Seoul Semiconductor recommends utilizing:

- A surge protection circuit
- An appropriately rated over voltage protection device
- A current limiting device