

IEC Appliance Inlet C14 with Fuseholder 1- or 2-pole, Line Switch 2-pole and Voltage Selector



IEC connector C14 with fuse holder 1- or 2-pole with voltage selector and line switch 2-pole  
 Screw-on version from front or rear side

Snap-in version from front side



See below:  
[Approvals and Compliances](#)

**Description**

- Panel mount :  
 Screw-on version from front or rear side, snap-in version front side
- 4 Functions :  
 Appliance Inlet , Protection class I Line Switch , 2-pole Fuseholder with interchangeable fuse drawer for Fuse-links 5x20 mm or 6.3x32 mm , Voltage Selector Meets the requirements of IEC 60335-1 for appliances in unattended use. This includes the enhanced requirements of glow wire tests acc. to IEC 60695-2-12 and -13.
- Quick connect terminals 4.8 x 0.8 mm

**Characteristics**

- All single elements are already partially wired
- For added safety "Extra-Safe" fuse drawers are available
- Suitable for use in equipment according to IEC/UL 62368-1

**Other versions on request**

- Line switch, illuminated
- Line switch with other rocker marking
- Line switch 1-pole
- For protection class II

**References**

Alternative: version with line filter [CG](#)

**Weblinks**

[pdf data sheet](#), [html datasheet](#), [General Product Information](#), [Approvals](#), [Distributor-Stock-Check](#), [Accessories](#), [Detailed request for product](#)

Newly available variants corresponding to V-Lock mating cordset. The connector is equipped with a notch intended for use with the latching cordset. The cord latching system prevents against accidental removal of the cordset.

**Technical Data**

Ratings IEC	10A / 250VAC; 50Hz	Appliance inlet/-outlet	C14 acc. to IEC 60320-1, UL 60320-1, CSA C22.2 no. 60320-1 (for cold conditions) pin-temperature 70 °C, 10A, Protection Class I
Ratings UL/CSA	10A / 250VAC; 60Hz	Fuseholder	1-/2-pole, Shocksafe category PC2 acc. to IEC 60127-6, for fuse-links 5 x 20 / 6.3 x 32 mm
Dielectric Strength	> 3 kVAC between L-N > 4 kVAC between L/N-PE (1 min/50Hz)	Rated Power Acceptance @ Ta 23 °C	5 x 20: 2.5W (1 pole)/ 2W (2-pole) per pole 6.3 x 32: 3.15W (1 pole)/ 2.5W (2-pole) per pole
Allowable Operation Temperature	-25 °C to 70 °C	Power Acceptance @ Ta > 23 °C	Admissible power acceptance at higher ambient temperature see derating curves
IP-Protection	front side IP40 acc. to IEC 60529	Line Switch	Rocker switch 2-pole, non-illuminated, acc. to IEC 61058-1 <a href="#">Technical Details</a>
Protection against electric shock	Suitable for appliances with protection class I acc. to IEC 61140	Voltage Selector	series-parallel, 4, 3 or 2 switch positions or usable as 2-pole change-over switch
Terminal	Quick connect terminals 4.8 x 0.8 mm		
Panel Thickness S	Screw: max 8 mm Mounting screw torque max 0.5Nm Snap-in: 1.5/2/2.5 mm		
Material: Housing	Thermoplastic, black, UL 94V-0		



**Approvals and Compliances**

Detailed information on product approvals, code requirements, usage instructions and detailed test conditions can be looked up in [Details about Approvals](#)

SCHURTER products are designed for use in industrial environments. They have approvals from independent testing bodies according to national and international standards. Products with specific characteristics and requirements such as required in the automotive sector according to IATF 16949, medical technology according to ISO 13485 or in the aerospace industry can be offered exclusively with customer-specific, individual agreements by SCHURTER.





### Approvals

The approval mark is used by the testing authorities to certify compliance with the safety requirements placed on electronic products.  
 Approval Reference Type: KG

Approval Logo	Certificates	Certification Body	Description
	VDE Approvals	VDE	Certificate Number: 40046766
	UL Approvals	UL	UR File Number: E93617



### Product standards

Product standards that are referenced

Organization	Design	Standard	Description
	Designed according to	IEC 60320-1	Appliance couplers for household and similar general purposes
	Designed according to	IEC 60127-6	Miniature fuses. Part 6. Fuse-holders for miniature fuse-links
	Designed according to	IEC 61058-1	Switches for appliances. Part 1. General requirements
	Designed according to	UL 60320-1	Standard for Attachment Plugs and Receptacles
	Designed according to	CSA C22.2 no. 60320-1	General Use Receptacles, Attachment Plugs, and Similar Wiring Devices

### Application standards

Application standards where the product can be used

Organization	Design	Standard	Description
	Suitable for applications acc.	IEC/UL 62368-1	Audio/video, information and communication technology equipment - Part 1: Safety requirements
	Suitable for applications acc.	IEC 60601-1	Medical electrical equipment - Part 1: General requirements for basic safety and essential performance
	Suitable for applications acc.	IEC 60335-1	Safety of electrical appliances for household and similar purposes. Meets the requirements for appliances in unattended use. This includes the enhanced requirements of glow wire tests acc. to IEC 60695-2-11 or -12 & -13.

### Compliances

The product complies with following Guide Lines

Identification	Details	Initiator	Description
	CE declaration of conformity	SCHURTER AG	The CE marking declares that the product complies with the applicable requirements laid down in the harmonisation of Community legislation on its affixing in accordance with EU Regulation 765/2008.
	UKCA declaration of conformity	SCHURTER AG	The UKCA marking declares that the product complies with the applicable requirements laid down in the British Amendment of Regulation (EC) 765/2008.
	RoHS	SCHURTER AG	Directive RoHS 2011/65/EU, Amendment (EU) 2015/863
	China RoHS	SCHURTER AG	The law SJ / T 11363-2006 (China RoHS) has been in force since 1 March 2007. It is similar to the EU directive RoHS.
	REACH	SCHURTER AG	On 1 June 2007, Regulation (EC) No 1907/2006 on the Registration, Evaluation, Authorization and Restriction of Chemicals 1 (abbreviated as "REACH") entered into force.
		SCHURTER AG	V-Lock system are based on a matching plug-dose combination. The connector is equipped with a notch intended for use with the latching cordset. The cord latching system prevents against accidental removal of the cordset.
	White Paper Glow wire test	SCHURTER AG	Meets the requirements of IEC 60335-1 for appliances in unattended use. This includes the enhanced requirements of glow wire tests acc. to IEC 60695-2-11 or -12 & -13.
	Medical Equipment	SCHURTER AG	Suitable for use in medical equipment according to IEC/UL 60601-1 (1 MOOP, 1 MOPP)

Dimensions [mm]

Screw-on mounting

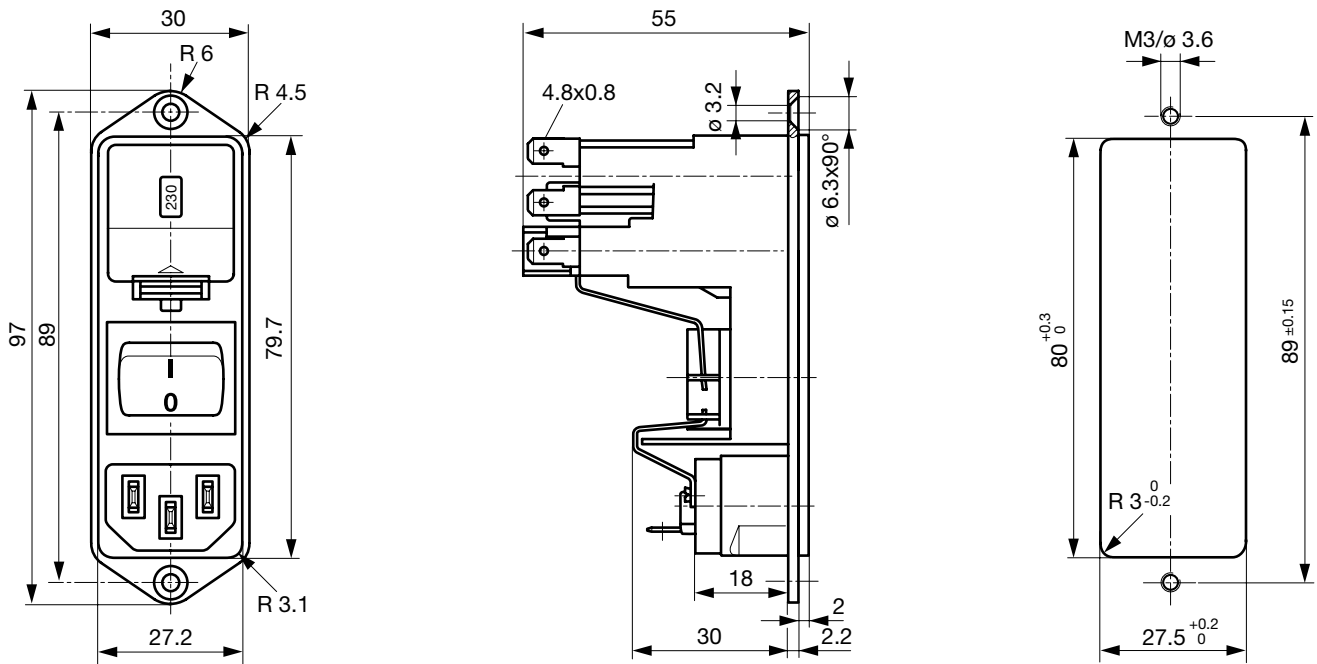

Snap-in mounting

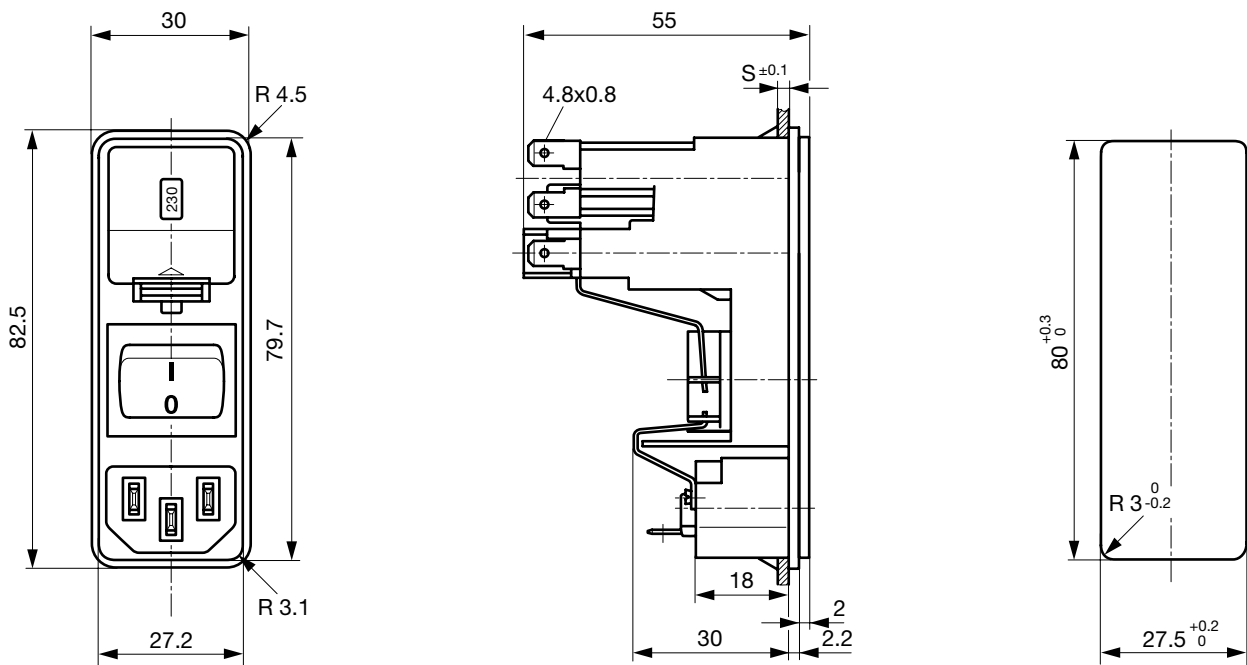

Diagrams

with partial wired

with partial wired

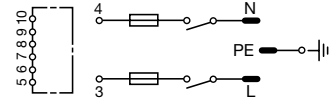
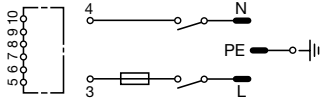

1-pole

2-pole

Derating Curves

Fuses  
 5 x 20 mm (1-pole)

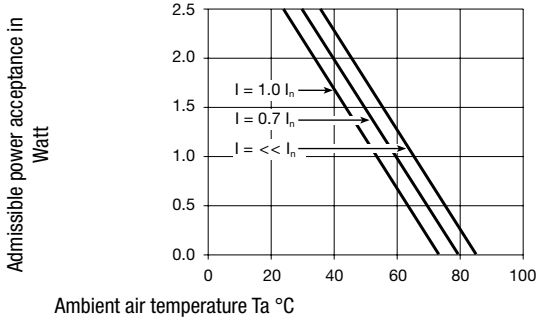

Fuses  
 5 x 20 mm (2-pole, per pole)

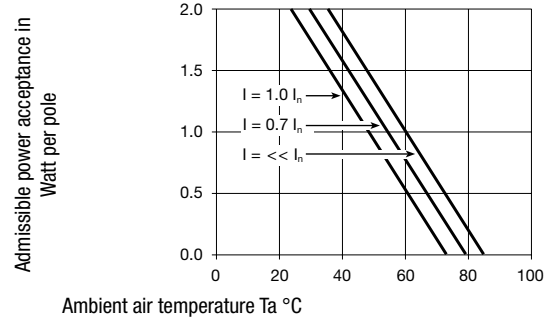

Fuses  
 6.3 x 32 mm (1-pole)

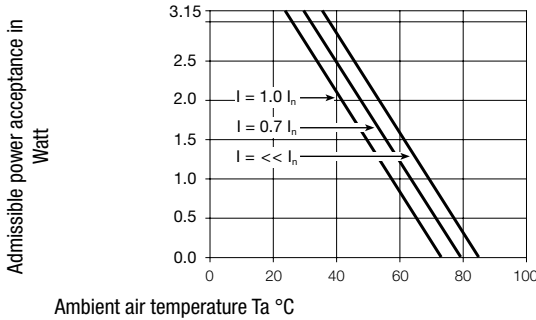

Fuses  
 6.3 x 32 mm (2-pole, per pole)

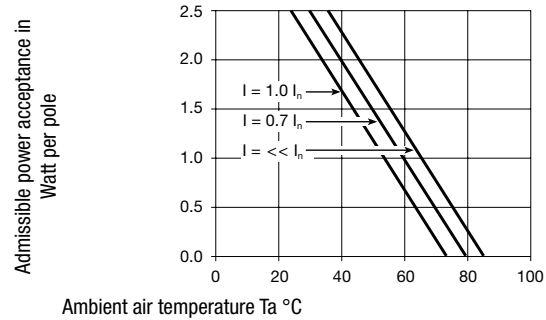

All Variants

Type	Panel mounting	Panel Thickness s [mm]	Fuseholder	Line Switch	V-Lock	Order Number
KG	Snap-in	1.5	1-pole	Rocker switch		KG16.5101.105
KG	Snap-in	2	1-pole	Rocker switch		KG16.5101.107
KG	Snap-in	2.5	1-pole	Rocker switch		KG16.5101.109
KG	Snap-in	1.5	2-pole	Rocker switch		KG10.6101.105
KG	Snap-in	2	2-pole	Rocker switch		KG10.6101.107
KG	Snap-in	2.5	2-pole	Rocker switch		KG10.6101.109
KG	Screw	-	1-pole	Rocker switch		KG16.5101.151
KG	Screw	-	2-pole	Rocker switch	●	3-121-063
KG	Screw	-	2-pole	Rocker switch		KG10.6101.151

Most Popular.

Availability for all products can be searched real-time: <https://www.schurter.com/en/Stock-Check/Stock-Check-SCHURTER>



The fuse drawer is not included and must be ordered separately (see required accessory).

Packaging unit



20 Pcs

**Required Accessory**

**Description**

	<p><a href="#">Fusedrawer_1</a>                      Fusedrawer for Fuse Links 5x20 mm resp. 6.3x32 mm</p>	
	5 x 20, 2-pole	4305.0001
	5 x 20, 1-pole	4305.0006
	6.3 x 32, 2-pole	4305.0011
	6.3 x 32, 1-pole	4305.0016
...		
	<p><a href="#">Jumper_Wire_1</a>                      Connection with Stranded Cable</p>	
	Type A, 70 mm	0881.0074
	Type A, 100 mm	0881.0075
	Type B, 70 mm	0881.0076
	Type B, 100 mm	0881.0077
...		
	<p><a href="#">Voltage_Selectors_Insert_1</a>                      Voltage Selector Insert to KE, CE, KG, CG</p>	
	3 or 4 switch positions	4305.0048.00
	1, 3 or 4 switch positions, 100, 120, 220, 240	4305.0048.01
	3, 3 or 4 switch positions, 130, 110, 240, 220	4305.0048.02
	2, 2 switch positions, 110, 220	4305.0048.03
...		

**Accessories**

	<p><a href="#">Assorted_Covers</a>                      Rear Cover</p>	
		0859.0109
	<p><a href="#">RC320</a>                      Rear Cover for Power Entry Module</p>	
	<p><a href="#">Cord_retaining_kits</a>                      Cord retaining strain relief</p>	
	Flat head, A	4700.0001

**Mating Outlets/Connectors**

**Category / Description**

[Appliance Outlet Overview complete](#)



4787, Mounting: Screw-on mounting, Appliance Outlet: IEC Solder terminals, 10 A, Suitable for appliances with protection class I	4787
4788, Mounting: Snap-in version, Appliance Outlet: IEC Solder / Quick Connect, 10 A, Suitable for appliances with protection class I	4788
IEC Appliance Outlet F or H, Screw-on Mounting, Front Side, Solder, PCB or Quick-connect Terminal	5091

[Connector Overview complete](#)



4782 Mounting: Power Cord, 3 x 1 mm <sup>2</sup> / 3 x 18 AWG, Cable, Connector: IEC C13	4782
4785 Mounting: Power Cord, 3 x 1 mm <sup>2</sup> / 3 x 18 AWG, Cable, Connector: IEC C13	4785
4300-06 Mounting: Power Cord, 3 x 1 mm <sup>2</sup> / 3 x 18 AWG, Cable, Connector: IEC C13	4300-06
4781 Mounting: Power Cord, Cable, Connector: IEC C15	4781
4784 Mounting: Power Cord, 3 x 1 mm <sup>2</sup> / 3 x 18 AWG, Cable, Connector: IEC C15	4784

**Mating Outlets/Connectors shuttered**

[Connector Overview complete](#)



4783 Mounting: Power Cord, 3 x 1 mm <sup>2</sup> / 3 x 18 AWG, Cable, Connector: IEC C13	4783
--	------

[Power Cord Overview complete](#)



VAC13KS, Overview, V-Lock cord retaining, diverse Connector IEC C13, diverse, black	VAC13KS
---	---------