

CKT SIZE	DIMENSION				
	A	B	C	D	E
4	2.00	4.85	6.65	5.00	---
6	4.00	6.85	8.65	7.00	---
8	6.00	8.85	10.65	9.00	---
10	8.00	10.85	12.65	11.00	---
12	10.00	12.85	14.65	13.00	---
14	12.00	14.85	16.65	15.00	8.00
16	14.00	16.85	18.65	17.00	10.00
18	16.00	18.85	20.65	19.00	12.00
20	18.00	20.85	22.65	21.00	14.00
22	20.00	22.85	24.65	23.00	16.00
24	22.00	24.85	26.65	25.00	18.00
26	24.00	26.85	28.65	27.00	20.00
28	26.00	28.85	30.65	29.00	22.00
30	28.00	30.85	32.65	31.00	24.00
32	30.00	32.85	34.65	33.00	26.00
34	32.00	34.85	36.65	35.00	28.00
36	34.00	36.85	38.65	37.00	30.00
38	36.00	38.85	40.65	39.00	32.00
40	38.00	40.85	42.65	41.00	34.00
42	40.00	42.85	44.65	43.00	36.00
44	42.00	44.85	46.65	45.00	38.00
46	44.00	46.85	48.65	47.00	40.00
48	46.00	48.85	50.65	49.00	42.00
50	48.00	50.85	52.65	51.00	44.00

- NOTES:
- FOR ILLUSTRATION PURPOSES, 20 CIRCUIT SIZE WAFER IS SHOWN.
  - MATERIAL : HOUSING : LCP, UL94V-0, GLOW WIRE CAPABLE PER IEC-60335-1 5TH EDITION, GLASS FILLED. COLOR: BLACK. PIN : 0.50MM SQ. COPPER ALLOY.
  - PRODUCT SPECIFICATION PS-151117-0001 APPLIES.
  - RIB LOCATION VARIES, DEPENDING ON CIRCUIT SIZES.
  - CKT 4 AND 6 HAS NO IDENTIFICATION TAG.
  - REFER TO PACKAGING SPECIFICATION FOR TAPE & REEL : PK-151120-3000
  - POSITION OF KAPTON TAPE TO BE LOCATED AT CENTER OF DIM A, IRREGARDLESS OF CKT SIZES. TOP SURFACE OF KAPTON TAPE TO BE FLAT FOR PICK & PLACE PURPOSE.
  - BEND DEPRESSION ON SMT TAIL IS ACCEPTABLE SO LONG AS IT DOES NOT AFFECT THE OVERALL COPLANARITY OF THE TAIL.
  - CAVITY ID AND MX LOGO SHALL BE APPROXIMATELY AS SHOWN.

HSE LENGTH ADDED	REV	DESCRIPTION	QUALITY SYMBOLS	GENERAL TOLERANCES (UNLESS SPECIFIED)		DRAWN BY	DATE	TITLE
				mm	INCH			
2017/09/07	A2	DRW:NEANG	$F_A=0$	4 PLACES	± ---	ATSEE	2015/03/06	ASSEMBLY MGRID, SHROUDED HEADER RIGHT ANGLE SMT
2017/10/01		CHKD:CGOH	$F_G=0$	3 PLACES	± ---	CHECKED BY	DATE	
2017/10/02		APPR:KHLIM	$F_P=0$	2 PLACES	± 0.20	CGOH	2015/03/05	
				1 PLACE	± ---	APPROVED BY	DATE	
				0 PLACE	± ---	KHLIM	2015/11/05	
				ANGULAR ± 3 °		MATERIAL NO.		DOCUMENT NO.
				DRAFT WHERE APPLICABLE MUST REMAIN WITHIN DIMENSIONS		SEE TABLE		SD-151120-0001
						SIZE A3		SHEET NO. 1 OF 2

DIMENSION STYLE	SCALE	DESIGN UNITS	THIRD ANGLE PROJECTION
MM ONLY	NTS	METRIC	

10 9 8 7 6 5 4 3 2 1

ASSEMBLY  
151120 - X X X X

04 - 50 4CKT ~ 50CKT W/O PEG

PLATING		KAPTON VERSION
0	FULL TIN	WITHOUT KAPTON TAPE 14CKTS ~ 50CKTS
1	Au FLASH	
2	0.38 Au	
3	0.75 Au	WITH KAPTON TAPE 4CKTS -12CKTS
4	FULL TIN	
5	Au FLASH	
6	0.38 Au	
7	0.75 Au	

PACKAGING	
0	TAPE & REEL

PLATING OPTIONS

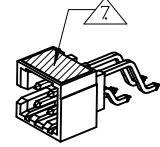
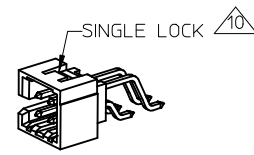
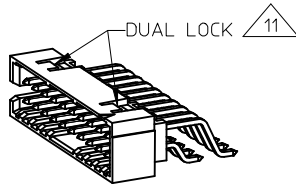

-X0XX AND -X4XX	2.00µm MIN. TIN OVERALL 1.25µm MIN. NICKEL OVERALL
-X1XX AND -X5XX	0.05µm MIN. GOLD PLATE ON CONTACT AND 2.00µm MIN. TIN(MATTE) ON SOLDER TAIL OVER 1.25µm MIN. NICKEL OVERALL.
-X2XX AND -X6XX	0.38µm MIN. GOLD PLATE ON CONTACT AND 2.00µm MIN. TIN(MATTE) ON SOLDER TAIL OVER 1.25µm MIN. NICKEL OVERALL.
-X3XX AND -X7XX	0.75µm MIN. GOLD PLATE ON CONTACT AND 2.00µm MIN. TIN(MATTE) ON SOLDER TAIL OVER 1.25µm MIN. NICKEL OVERALL.

KAPTON TAPE IS USED FOR 4 - 12CKT ONLY 



REFERENCE OF KAPTON TAPE PLACEMENT OF 4CKT

NOTES CONTINUE.

-  SINGLE LOCK FEATURE FOR 4-12CKT.
-  DUAL LOCK FEATURE FOR 14CKT AND ABOVE.
-  DETAIL 1 FOR MMC REFERENCE ONLY.

<b>HSE LENGTH ADDED</b> EC NO: S2018-0108 DRW:NEANG CHKD:CGOH APPR:KHL IM	2017/09/07 2017/10/01 2017/10/02	QUALITY SYMBOLS $F_A=0$ $F_G=0$ $F_P=0$	GENERAL TOLERANCES (UNLESS SPECIFIED)		DIMENSION STYLE <b>MM ONLY</b>		SCALE NTS	DESIGN UNITS METRIC	THIRD ANGLE PROJECTION				
			mm	INCH	DRAWN BY ATSEE	DATE 2015/03/06	TITLE <b>ASSEMBLY MGRID, SHROUDED HEADER RIGHT ANGLE SMT</b>						
			4 PLACES	± ---	± ---	CHECKED BY CGOH	DATE 2015/03/05	 DOCUMENT NO. SD-151120-0001 SHEET NO. 2 OF 2					
			3 PLACES	± ---	± ---	APPROVED BY KHL IM	DATE 2015/11/05						
		2 PLACES	± 0.20	± ---	MATERIAL NO. <b>SEE TABLE</b>		THIS DRAWING CONTAINS INFORMATION THAT IS PROPRIETARY TO MOLEX INCORPORATED AND SHOULD NOT BE USED WITHOUT WRITTEN PERMISSION						
		1 PLACE	± ---	± ---	SIZE A3								
		0 PLACE	± ---	± ---	DRAFT WHERE APPLICABLE MUST REMAIN WITHIN DIMENSIONS								

9 8 7 6 5 4 3 2 1

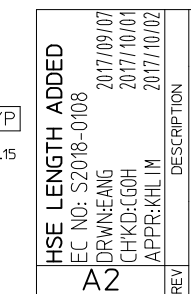
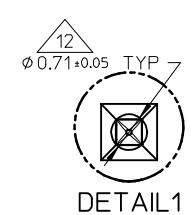
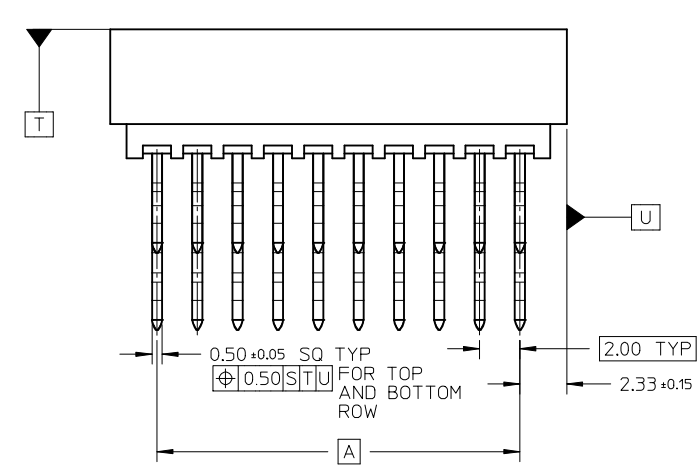
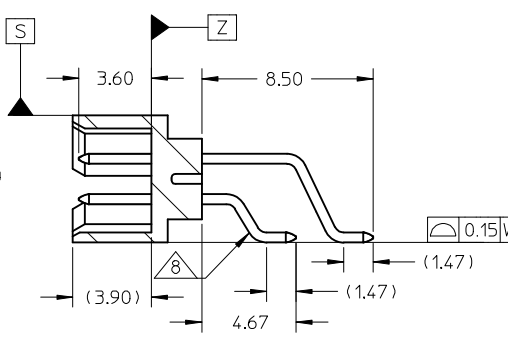
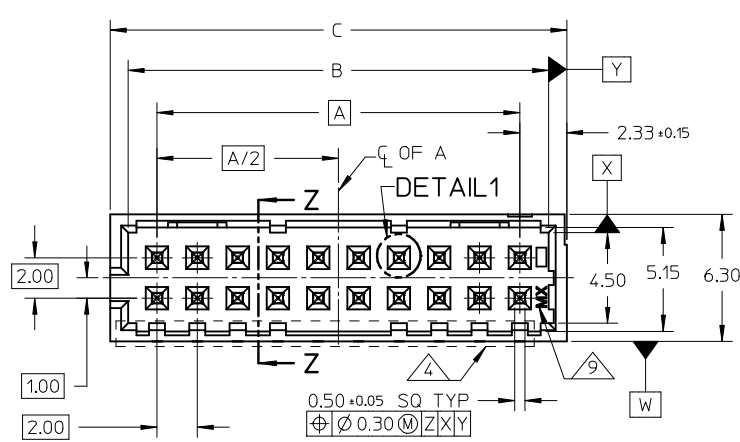
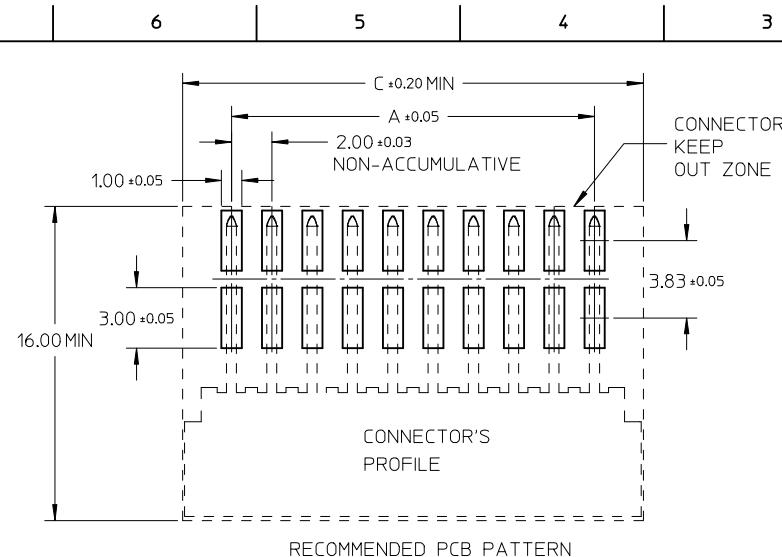
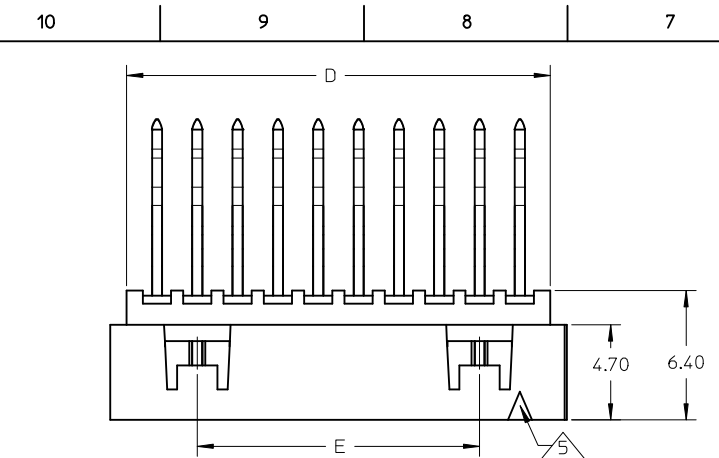

CKT SIZE	DIMENSION				
	A	B	C	D	E
4	2.00	4.85	6.65	5.00	---
6	4.00	6.85	8.65	7.00	---
8	6.00	8.85	10.65	9.00	---
10	8.00	10.85	12.65	11.00	---
12	10.00	12.85	14.65	13.00	---
14	12.00	14.85	16.65	15.00	8.00
16	14.00	16.85	18.65	17.00	10.00
18	16.00	18.85	20.65	19.00	12.00
20	18.00	20.85	22.65	21.00	14.00
22	20.00	22.85	24.65	23.00	16.00
24	22.00	24.85	26.65	25.00	18.00
26	24.00	26.85	28.65	27.00	20.00
28	26.00	28.85	30.65	29.00	22.00
30	28.00	30.85	32.65	31.00	24.00
32	30.00	32.85	34.65	33.00	26.00
34	32.00	34.85	36.65	35.00	28.00
36	34.00	36.85	38.65	37.00	30.00
38	36.00	38.85	40.65	39.00	32.00
40	38.00	40.85	42.65	41.00	34.00
42	40.00	42.85	44.65	43.00	36.00
44	42.00	44.85	46.65	45.00	38.00
46	44.00	46.85	48.65	47.00	40.00
48	46.00	48.85	50.65	49.00	42.00
50	48.00	50.85	52.65	51.00	44.00

- NOTES:
- FOR ILLUSTRATION PURPOSES, 20 CIRCUIT SIZE WAFER IS SHOWN.
  - MATERIAL : HOUSING : LCP, UL94V-0, GLOW WIRE CAPABLE PER IEC-60335-1 5TH EDITION, GLASS FILLED. COLOR: BLACK. PIN : 0.50MM SQ. COPPER ALLOY.
  - PRODUCT SPECIFICATION PS-151117-0001 APPLIES.
  - RIB LOCATION VARIES, DEPENDING ON CIRCUIT SIZES.
  - CKT 4 AND 6 HAS NO IDENTIFICATION TAG.
  - REFER TO PACKAGING SPECIFICATION FOR TAPE & REEL : PK-151120-3000
  - POSITION OF KAPTON TAPE TO BE LOCATED AT CENTER OF DIM A, IRRESPECTIVE OF CKT SIZES. TOP SURFACE OF KAPTON TAPE TO BE FLAT FOR PICK & PLACE PURPOSE.
  - BEND DEPRESSION ON SMT TAIL IS ACCEPTABLE SO LONG AS IT DOES NOT AFFECT THE OVERALL COPLANARITY OF THE TAIL.
  - CAVITY ID AND MX LOGO SHALL BE APPROXIMATELY AS SHOWN.

HSE LENGTH ADDED	REV	DESCRIPTION	QUALITY SYMBOLS	GENERAL TOLERANCES (UNLESS SPECIFIED)		DRAWN BY	DATE	TITLE
				mm	INCH			
2017/09/07	A2	DRW:NEANG	$F_A=0$	4 PLACES	± ---	ATSEE	2015/03/06	ASSEMBLY MGRID, SHROUDED HEADER RIGHT ANGLE SMT
2017/10/01		CHKD:CGOH	$F_G=0$	3 PLACES	± ---	CHECKED BY	DATE	
2017/10/02		APPR:KHLIM	$F_P=0$	2 PLACES	± 0.20	CGOH	2015/03/05	
				1 PLACE	± ---	APPROVED BY	DATE	
				0 PLACE	± ---	KHLIM	2015/11/05	

DIMENSION STYLE	SCALE	DESIGN UNITS	THIRD ANGLE PROJECTION
MM ONLY	NTS	METRIC	
DRAWN BY: ATSEE DATE: 2015/03/06			
CHECKED BY: CGOH DATE: 2015/03/05			
APPROVED BY: KHLIM DATE: 2015/11/05			
MATERIAL NO. SEE TABLE		DOCUMENT NO. SD-151120-0001	
SIZE A3			SHEET NO. 1 OF 2

10 9 8 7 6 5 4 3 2 1

ASSEMBLY  
151120 - X X X X

04 - 50 4CKT ~ 50CKT W/O PEG

PLATING		KAPTON VERSION
0	FULL TIN	WITHOUT KAPTON TAPE 14CKTS ~ 50CKTS
1	Au FLASH	
2	0.38 Au	
3	0.75 Au	WITH KAPTON TAPE 4CKTS ~12CKTS
4	FULL TIN	
5	Au FLASH	
6	0.38 Au	
7	0.75 Au	

PACKAGING	
0	TAPE & REEL

PLATING OPTIONS

-X0XX AND -X4XX	2.00µm MIN. TIN OVERALL 1.25µm MIN. NICKEL OVERALL
-X1XX AND -X5XX	0.05µm MIN. GOLD PLATE ON CONTACT AND 2.00µm MIN. TIN(MATTE) ON SOLDER TAIL OVER 1.25µm MIN. NICKEL OVERALL.
-X2XX AND -X6XX	0.38µm MIN. GOLD PLATE ON CONTACT AND 2.00µm MIN. TIN(MATTE) ON SOLDER TAIL OVER 1.25µm MIN. NICKEL OVERALL.
-X3XX AND -X7XX	0.75µm MIN. GOLD PLATE ON CONTACT AND 2.00µm MIN. TIN(MATTE) ON SOLDER TAIL OVER 1.25µm MIN. NICKEL OVERALL.

KAPTON TAPE IS USED FOR 4 - 12CKT ONLY

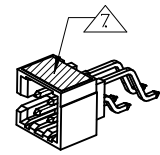
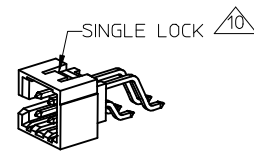
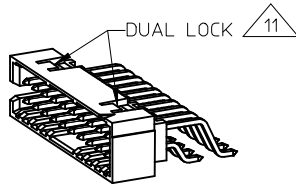

REFERENCE OF KAPTON TAPE PLACEMENT OF 4CKT

NOTES CONTINUE.

- SINGLE LOCK FEATURE FOR 4-12CKT.
- DUAL LOCK FEATURE FOR 14CKT AND ABOVE.
- DETAIL 1 FOR MMC REFERENCE ONLY.

HSE LENGTH ADDED	EC NO: S2018-0108	DRW:NEANG	CHKD:CGOH	APPR:KHL IM	REV	DESCRIPTION	QUALITY SYMBOLS	GENERAL TOLERANCES (UNLESS SPECIFIED)		DIMENSION STYLE		SCALE	DESIGN UNITS	THIRD ANGLE PROJECTION			
								mm	INCH	MM ONLY	NTS	METRIC	DATE	DATE	DATE	DATE	TITLE
A2							$F_A=0$ $F_G=0$ $F_P=0$	4 PLACES ± --- ± ---	3 PLACES ± --- ± ---	2 PLACES ± 0.20 ± ---	1 PLACE ± --- ± ---	0 PLACE ± --- ± ---	ANGULAR ± 3 °	DRAFT WHERE APPLICABLE MUST REMAIN WITHIN DIMENSIONS	DRAWN BY: ATSEE CHECKED BY: CGOH APPROVED BY: KHL IM DATE: 2015/03/06 DATE: 2015/03/05 DATE: 2015/11/05	TITLE: ASSEMBLY MGRID, SHROUDED HEADER RIGHT ANGLE SMT <b>molex</b> DOCUMENT NO.: SD-151120-0001	2 OF 2
										SIZE: A3	THIS DRAWING CONTAINS INFORMATION THAT IS PROPRIETARY TO MOLEX INCORPORATED AND SHOULD NOT BE USED WITHOUT WRITTEN PERMISSION						

9 8 7 6 5 4 3 2 1