

# SMD Power Inductor CDRH50D28R



## Description

- Ferrite drum core construction.
- Magnetically shielded.
- L × W × H: 5.3 × 5.3 × 3.0mm Max.
- Product weight: 0.25g(Ref.)
- Moisture Sensitivity Level: 1
- RoHS compliance.

## Environmental Data

- Operating temperature range: -40°C~+105°C (including coil's self temperature rise)
- Storage temperature range: -40°C~+105°C
- Solder reflow temperature: 260 °C peak.

## Packaging

- Carrier tape and reel packaging.
- 13.0" diameter reel
- 2000pcs per reel

## Applications

- Ideally used in Mobilephone, PDA, MP3, DSC/ DVC, HDD, etc as DC-DC converter inductors.

## Dimension - [mm]

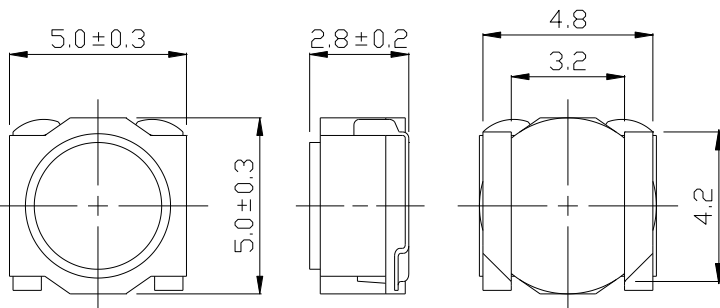

## Land pattern and Schematics - [mm]

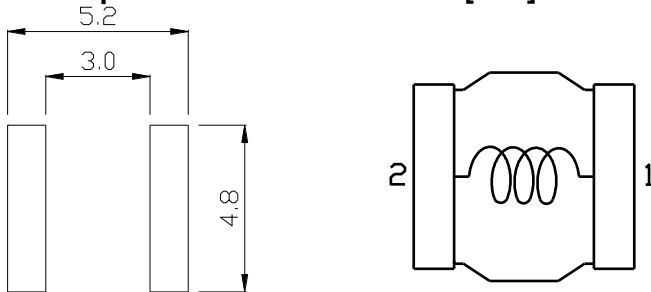

## Electrical Characteristics

Part No.	Stamp	Inductance (μH) [Within] ※1	D.C.R. (mΩ) [Within] (at 20°C)	Saturation current (A) ※2		Temperature rise current (A) ※3
				(at 20°C)	(at 105°C)	
CDRH50D28RNP-1R2NC	A	1.2 ± 30%	13 ± 25%	4.80	4.10	5.40
CDRH50D28RNP-1R6NC	B	1.6 ± 30%	15 ± 25%	4.20	3.60	4.70
CDRH50D28RNP-2R2NC	C	2.2 ± 30%	17 ± 25%	3.65	3.05	4.30
CDRH50D28RNP-3R0MC	D	3.0 ± 20%	25 ± 25%	3.10	2.55	3.50
CDRH50D28RNP-4R7MC	E	4.7 ± 20%	40 ± 25%	2.50	2.15	2.70
CDRH50D28RNP-6R8MC	F	6.8 ± 20%	61 ± 25%	2.10	1.75	2.20
CDRH50D28RNP-100MC	G	10 ± 20%	87 ± 25%	1.70	1.40	1.75
CDRH50D28RNP-150MC	H	15 ± 20%	140 ± 20%	1.40	1.10	1.30
CDRH50D28RNP-220MC	J	22 ± 20%	175 ± 20%	1.15	0.98	1.16
CDRH50D28RNP-330MC	K	33 ± 20%	248 ± 20%	0.94	0.78	0.98
CDRH50D28RNP-470MC	L	47 ± 20%	370 ± 20%	0.78	0.65	0.78

※1. Inductance measuring condition: at 100kHz.

※2. Saturation current: The value of D.C. current when the inductance decreases to 70% of its nominal value.

※3. Temperature rise current: The value of D.C. current when the temperature rise is Δt=40°C (Ta=20°C).

# SMD Power Inductor CDRH50D28R



## Saturation Current & Temperature Rise Graph

— L (20°C) — L (105°C) —  $\Delta T$

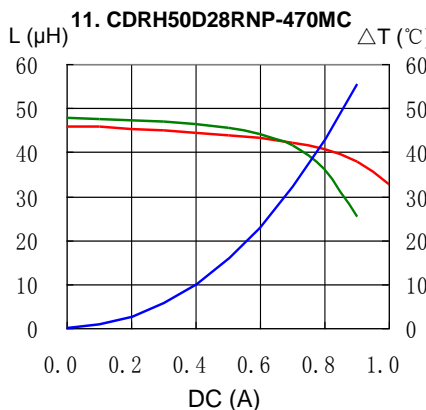
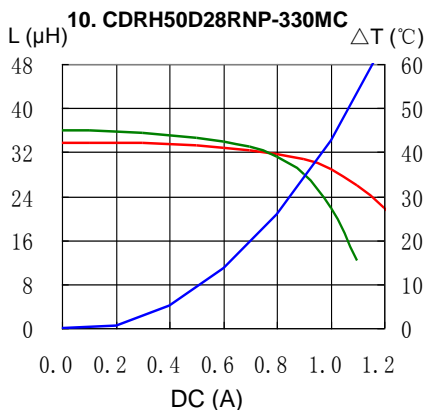
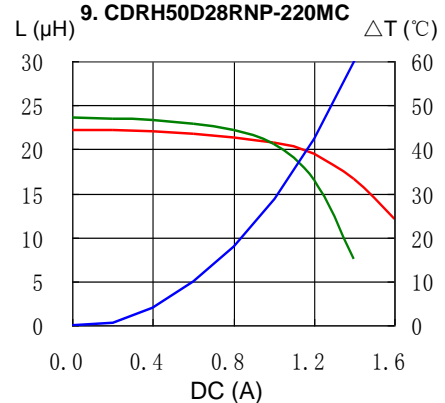
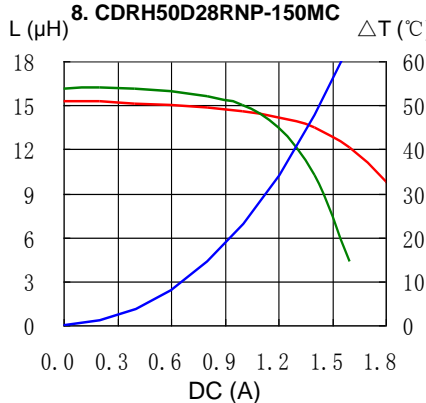
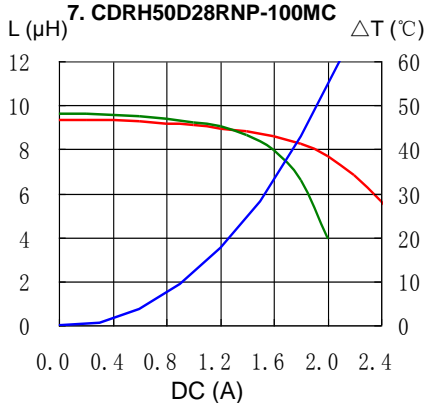
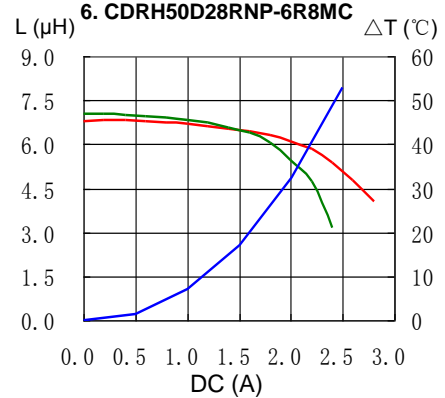
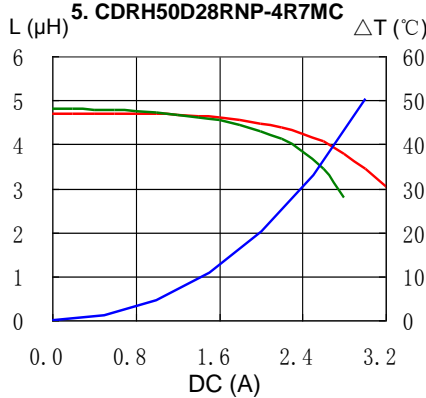
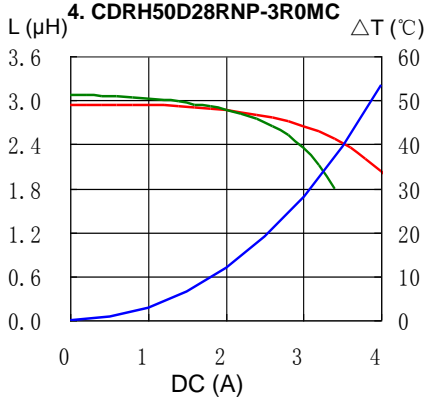
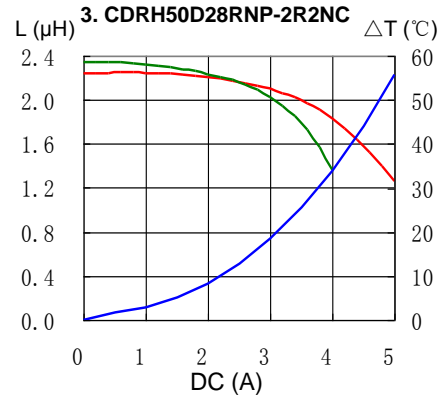
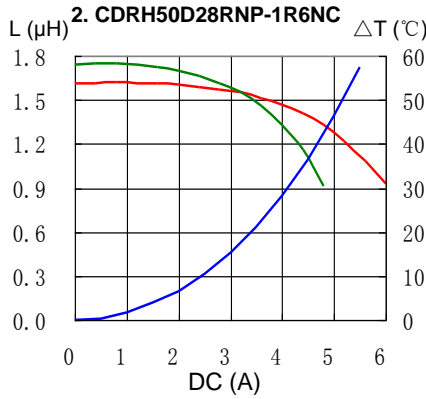
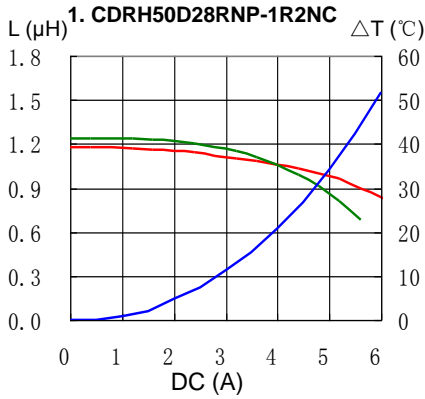

# SMD Power Inductor CDRH50D28R



## Solder Reflow Condition

Heat Endurance

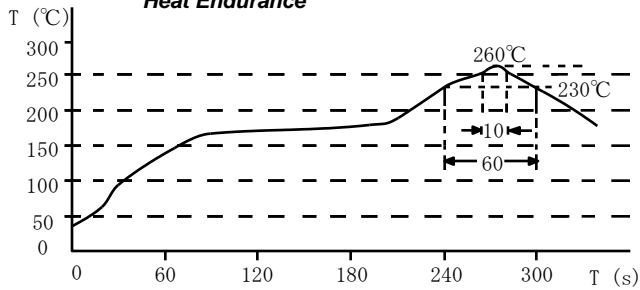

Temperature Chart

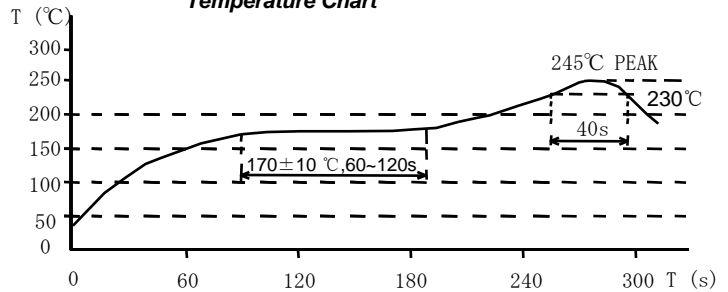

Please refer to the sales offices on our website - <http://www.sumida.com>

### Hong Kong

Tel.+852-2880-6781  
FAX.+852-2565-9600  
[sales@hk.sumida.com](mailto:sales@hk.sumida.com)

### Saitama(Japan)

Tel.+81-48-691-7300  
FAX.+81-48-691-7340  
[sales@jp.sumida.com](mailto:sales@jp.sumida.com)

### Chicago

Tel.+1-847-545-6700  
FAX. +1-847-545-6720  
[sales@us.sumida.com](mailto:sales@us.sumida.com)

### Shanghai

Tel.+86-21-5836-3299  
FAX.+86-21-5836-3266  
[shanghai.sales@cn.sumida.com](mailto:shanghai.sales@cn.sumida.com)

### Seoul

Tel.+82-2-6237-0777  
FAX.+82-2-6237-0778  
[sales@kr.sumida.com](mailto:sales@kr.sumida.com)

### Obernzell

Tel.+49-8591-937-0  
FAX. +49-8591-937-103  
[contact@eu.sumida.com](mailto:contact@eu.sumida.com)

### Shenzhen

Tel.+86-755-8291-0228  
FAX.+86-755-8291-0338  
[shenzhen.sales@cn.sumida.com](mailto:shenzhen.sales@cn.sumida.com)

### Singapore

Tel.+65-6296-3388  
FAX.+65-6841-4426  
[sales@sg.sumida.com](mailto:sales@sg.sumida.com)

### Neumarkt

Tel.+49-9181-4509-110  
FAX. +49-9181-4509-310  
[infocomp@eu.sumida.com](mailto:infocomp@eu.sumida.com)

### Taipei

Tel.+886-2-8751-2737  
FAX.+886-2-8751-2738  
[sales@tw.sumida.com](mailto:sales@tw.sumida.com)

### San Jose

Tel.+1-408-321-9660  
FAX.+1-408-321-9308  
[sales@us.sumida.com](mailto:sales@us.sumida.com)