

## XLamp® CMB1510 LED



### PRODUCT DESCRIPTION

The XLamp® CMB family delivers industry-leading lumen density and efficacy in Cree LED's package and LES sizes. Leveraging the latest COB technology platform, the CMB family provides a no-compromise performance upgrade to existing CXA, CXB and CMA product families while retaining mechanical and optical compatibility with them.

XLamp CMB LEDs are optimized for premium indoor lighting applications, including track, spot and downlight, as well as outdoor lighting.

### FEATURES

- 9-mm optical source
- Mechanical and optical design consistent with CXA15, CXB15 and CMA15 LEDs
- Available in 70, 80, 90, and 95 CRI minimum options
- EasyWhite® 2-, 3- and 5-step binning
- Premium Color 2- and 3-step binning
- Forward voltage option: 18-V & 36-V class
- 85 °C binning and characterization
- Maximum drive current: 900 mA
- 115° viewing angle, uniform chromaticity profile
- Top-side solder connections
- RoHS and REACH compliant
- UL® recognized component (E349212)



Cree LED / 4001 E. Hwy. 54, Suite 2000 / Durham, NC 27709 USA / +1.919.313.5330 / [www.cree-led.com](http://www.cree-led.com)

**TABLE OF CONTENTS**

---

Characteristics ..... 3

Operating Limits..... 4

Flux Characteristics, Order Codes & Bins - Standard LEDs - 18 V..... 5

Flux Characteristics, Order Codes & Bins - Standard LEDs, Premium Color - 36 V ..... 6

Flux Characteristics, Order Codes & Bins - Standard LEDs - 36 V..... 7

Flux Characteristics, Order Codes & Bins - Standard LEDs, Premium Color - 36 V..... 8

Relative Spectral Power Distribution, Standard LEDs..... 9

Relative Spectral Power Distribution, Premium Color LEDs..... 10

Electrical Characteristics..... 12

Relative Luminous Flux..... 13

Typical Spatial Distribution..... 14

EasyWhite® Performance Groups - Chromaticity..... 15

Premium Color Performance Groups - Chromaticity..... 16

EasyWhite® Bins Plotted on the 1931 CIE Color Space..... 17

Premium Color Bins Plotted on the 1931 CIE Color Space..... 18

Bin and Order Code Formats..... 20

Mechanical Dimensions ..... 21

Thermal Design..... 22

Notes ..... 24

Packaging..... 25

## CHARACTERISTICS

Characteristics	Unit	Minimum	Typical	Maximum
Viewing angle (FWHM)	degrees		115	
ESD withstand voltage (JEDEC JS-001-2012)	V		Class 3A	
DC forward current (18 V)	mA			1800*
DC forward current (36 V)	mA			900*
Reverse current	mA			0.1
Forward voltage (18 V, 700 mA, 85 °C)	V		17	19
Forward voltage (36 V, 350 mA, 85 °C)	V		34	38

\* Refer to the Operating Limits section.

## OPERATING LIMITS

The maximum current rating of the CMB1510 LED depends on the case temperature ( $T_c$ ) when the LED has reached thermal equilibrium under steady-state operation. The graphs shown below assume that the system design employs good thermal management (thermal interface material and heat sink) and may vary when poor thermal management is employed. Either solder pad shown in the Mechanical Dimensions section on page 21 can be used as the  $T_c$  measurement point.

Another important factor in good thermal management is the temperature of the Light Emitting Surface (LES). Cree LED recommends a maximum LES temperature of 140 °C to ensure optimal LED lifetime. Please refer to the Thermal Design section on page 22 for more information on LES temperature measurement.

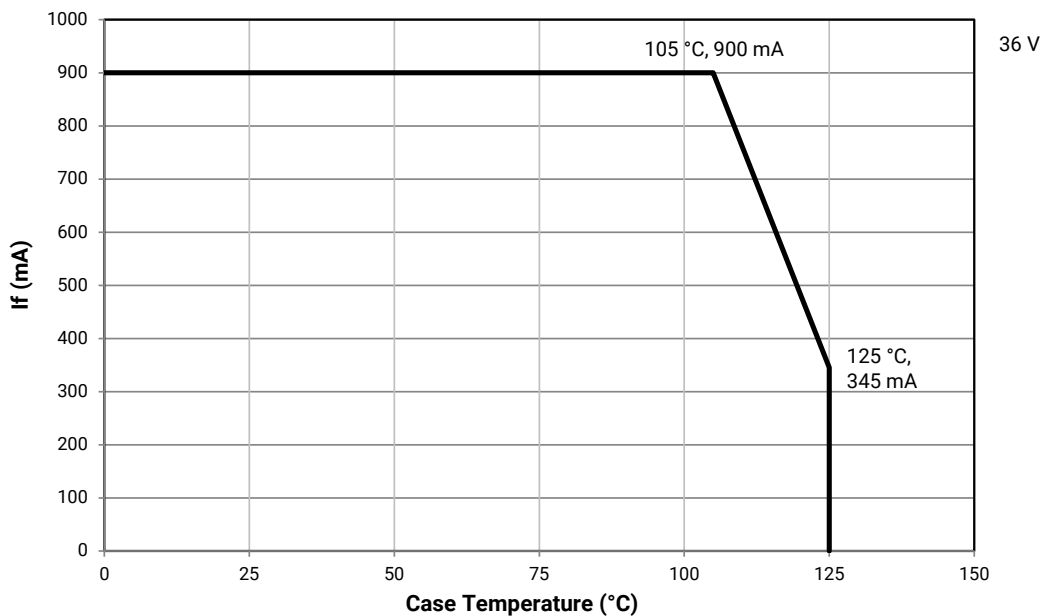
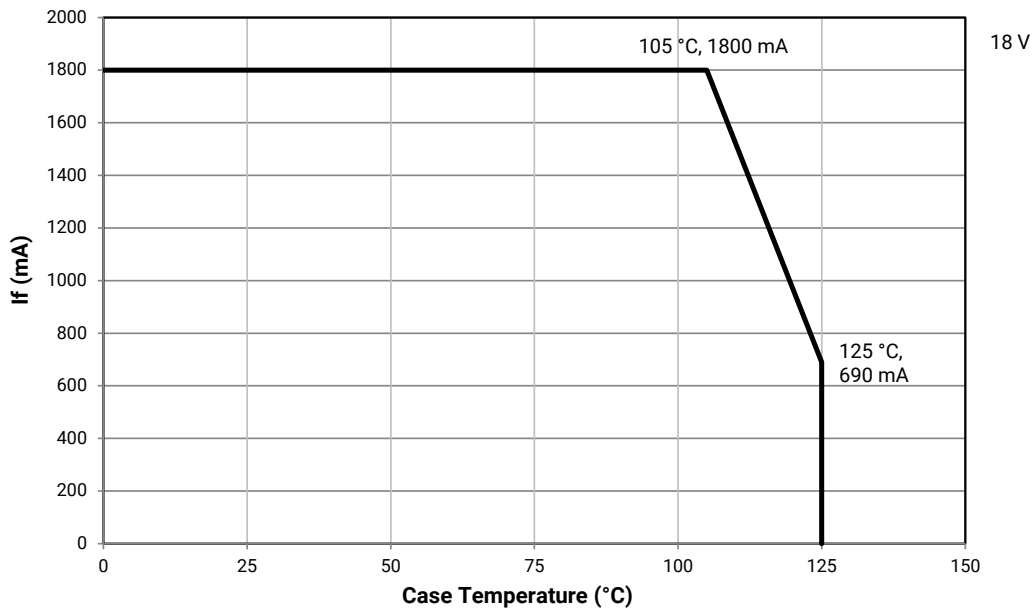

**FLUX CHARACTERISTICS, ORDER CODES & BINS - STANDARD LEDS - 18 V (I<sub>F</sub> = 700 mA, T<sub>J</sub> = 85 °C)**

The following tables provide order codes for XLamp CMB1510 LEDs. For a complete description of the order code nomenclature, please see the Bin and Order Code Formats section (page 20).

Nominal CCT	CRI		Minimum Luminous Flux (lm)	Typical Luminous Flux (lm)	2-Step		3-Step		5-Step	
	Min.	Typ			Group	Order Code	Group	Order Code	Group	Order Code
6500 K	70	73	1965	2108					65E	CMB1510-0000-000F0B0A65E
	80	82	1775	1904					65E	CMB1510-0000-000F0H0A65E
5700 K	70	73	1958	2100					57E	CMB1510-0000-000F0B0A57E
	80	82	1768	1897					57E	CMB1510-0000-000F0H0A57E
	90	92	1530	1641			57G	CMB1510-0000-000F0U0A57G		
5000 K	70	73	1946	2088					50E	CMB1510-0000-000F0B0A50E
	80	82	1758	1885			50G	CMB1510-0000-000F0H0A50G		
	90	92	1518	1629			50G	CMB1510-0000-000F0U0A50G		
4000 K	70	73	1925	2065					40E	CMB1510-0000-000F0B0A40E
	80	82	1739	1865	40H	CMB1510-0000-000F0H0A40H	40G	CMB1510-0000-000F0H0A40G		
	90	92	1496	1605	40H	CMB1510-0000-000F0U0A40H	40G	CMB1510-0000-000F0U0A40G		
3500 K	80	82	1721	1846	35H	CMB1510-0000-000F0H0A35H	35G	CMB1510-0000-000F0H0A35G		
	90	92	1492	1601	35H	CMB1510-0000-000F0U0A35H	35G	CMB1510-0000-000F0U0A35G		
3000 K	70	73	1879	2015					30E	CMB1510-0000-000F0B0A30E
	80	82	1748	1874	30H	CMB1510-0000-000F0H0A30H	30G	CMB1510-0000-000F0H0A30G		
	90	92	1476	1583	30H	CMB1510-0000-000F0U0A30H	30G	CMB1510-0000-000F0U0A30G		
2700 K	80	82	1624	1742	27H	CMB1510-0000-000F0H0A27H	27G	CMB1510-0000-000F0H0A27G		
	90	92	1417	1520	27H	CMB1510-0000-000F0U0A27H	27G	CMB1510-0000-000F0U0A27G		
2200 K	80	82	1440	1545			22G	CMB1510-0000-000F0H0A22G		

- Notes**
- Cree LED maintains a tolerance of ±7% on flux and power measurements, ±0.005 on chromaticity (CCx, CCy) measurements and a tolerance of ±2 on CRI measurements. See the Measurements section (page 24).
  - For 80 CRI minimum LEDs, CRI R9 minimum is 0 with a ±2 tolerance. For 90 CRI minimum LEDs, CRI R9 typical is 60.

## FLUX CHARACTERISTICS, ORDER CODES & BINS - STANDARD LEDS, PREMIUM COLOR - 18 V ( $I_f = 700 \text{ mA}$ , $T_j = 85 \text{ }^\circ\text{C}$ )

### Fidelity

Nominal CCT	CRI*		Minimum Luminous Flux (lm)	Typical Luminous Flux (lm)	2-Step	
	Min.	Typ			Group	Order Code
4000 K	95	98	1349	1447	40H	CMB1510-0000-000F0Z0A40H
3500 K	95	98	1343	1441	35H	CMB1510-0000-000F0Z0A35H
3000 K	95	98	1304	1399	30H	CMB1510-0000-000F0Z0A30H
2700 K	95	98	1243	1334	27H	CMB1510-0000-000F0Z0A27H

### Specialty

Nominal CCT	CRI		Minimum Luminous Flux (lm)	Typical Luminous Flux (lm)	2-Step		3-Step			
	Min.	Typ			Group	Order Code	Group	Order Code	Group	Order Code
3100 K	90	92	1409	1512			31Q	CMB1510-0000-000F0U0A31Q		
3000 K	90	92	1387	1488					30U	CMB1510-0000-000F0U0A30U
	90	92	1446	1551			30Q	CMB1510-0000-000F0U0A30Q		
	95	98	1228	1317	L7C	CMB1510-0000-000F0Z0AL7C				

### Notes

- Cree LED maintains a tolerance of  $\pm 7\%$  on flux and power measurements,  $\pm 0.005$  on chromaticity (CCx, CCy) measurements and a tolerance of  $\pm 2$  on CRI measurements. See the Measurements section (page 24).
- For 80 CRI minimum LEDs, CRI R9 minimum is 0 with a  $\pm 2$  tolerance. For 90 CRI minimum LEDs, CRI R9 typical is 60.

**FLUX CHARACTERISTICS, ORDER CODES & BINS - STANDARD LEDS - 36 V (I<sub>F</sub> = 350 mA, T<sub>J</sub> = 85 °C)**

The following tables provide order codes for XLamp CMB1510 LEDs. For a complete description of the order code nomenclature, please see the Bin and Order Code Formats section (page 20).

Nominal CCT	CRI		Minimum Luminous Flux (lm)	Typical Luminous Flux (lm)	2-Step		3-Step		5-Step	
	Min.	Typ			Group	Order Code	Group	Order Code	Group	Order Code
6500 K	70	73	1965	2108					65E	CMB1510-0000-000N0B0A65E
	80	82	1775	1904					65E	CMB1510-0000-000N0H0A65E
5700 K	70	73	1958	2100					57E	CMB1510-0000-000N0B0A57E
	80	82	1768	1897					57E	CMB1510-0000-000N0H0A57E
	90	92	1530	1641			57G	CMB1510-0000-000N0U0A57G		
5000 K	70	73	1946	2088					50E	CMB1510-0000-000N0B0A50E
	80	82	1758	1885			50G	CMB1510-0000-000N0H0A50G		
	90	92	1518	1629			50G	CMB1510-0000-000N0U0A50G		
4000 K	70	73	1925	2065					40E	CMB1510-0000-000N0B0A40E
	80	82	1739	1865	40H	CMB1510-0000-000N0H0A40H	40G	CMB1510-0000-000N0H0A40G		
	90	92	1496	1605	40H	CMB1510-0000-000N0U0A40H	40G	CMB1510-0000-000N0U0A40G		
3500 K	80	82	1721	1846	35H	CMB1510-0000-000N0H0A35H	35G	CMB1510-0000-000N0H0A35G		
	90	92	1492	1601	35H	CMB1510-0000-000N0U0A35H	35G	CMB1510-0000-000N0U0A35G		
3000 K	70	73	1879	2015					30E	CMB1510-0000-000N0B0A30E
	80	82	1748	1874	30H	CMB1510-0000-000N0H0A30H	30G	CMB1510-0000-000N0H0A30G		
	90	92	1476	1583	30H	CMB1510-0000-000N0U0A30H	30G	CMB1510-0000-000N0U0A30G		
2700 K	80	82	1624	1742	27H	CMB1510-0000-000N0H0A27H	27G	CMB1510-0000-000N0H0A27G		
	90	92	1417	1520	27H	CMB1510-0000-000N0U0A27H	27G	CMB1510-0000-000N0U0A27G		
2200 K	80	82	1440	1545			22G	CMB1510-0000-000N0H0A22G		

- Notes**
- Cree LED maintains a tolerance of ±7% on flux and power measurements, ±0.005 on chromaticity (CCx, CCy) measurements and a tolerance of ±2 on CRI measurements. See the Measurements section (page 24).
  - For 80 CRI minimum LEDs, CRI R9 minimum is 0 with a ±2 tolerance. For 90 CRI minimum LEDs, CRI R9 typical is 60.

**FLUX CHARACTERISTICS, ORDER CODES & BINS - STANDARD LEDS, PREMIUM COLOR - 36 V (I<sub>F</sub> = 350 mA, T<sub>J</sub> = 85 °C)**

**Fidelity**

Nominal CCT	CRI*		Minimum Luminous Flux (lm)	Typical Luminous Flux (lm)	2-Step	
	Min.	Typ			Group	Order Code
4000 K	95	98	1349	1447	40H	CMB1510-0000-000N0Z0A40H
3500 K	95	98	1343	1441	35H	CMB1510-0000-000N0Z0A35H
3000 K	95	98	1304	1399	30H	CMB1510-0000-000N0Z0A30H
2700 K	95	98	1243	1334	27H	CMB1510-0000-000N0Z0A27H

**Specialty**

Nominal CCT	CRI		Minimum Luminous Flux (lm)	Typical Luminous Flux (lm)	2-Step		3-Step			
	Min.	Typ			Group	Order Code	Group	Order Code	Group	Order Code
3100 K	90	92	1409	1512			31Q	CMB1510-0000-000N0U0A31Q		
3000 K	90	92	1387	1488					30U	CMB1510-0000-000N0U0A30U
	90	92	1446	1551			30Q	CMB1510-0000-000N0U0A30Q		
	95	98	1228	1317	L7C	CMB1510-0000-000N0Z0AL7C				

- Notes**
- Cree LED maintains a tolerance of ±7% on flux and power measurements, ±0.005 on chromaticity (CCx, CCy) measurements and a tolerance of ±2 on CRI measurements. See the Measurements section (page 24).
  - For 80 CRI minimum LEDs, CRI R9 minimum is 0 with a ±2 tolerance. For 90 CRI minimum LEDs, CRI R9 typical is 60.



RELATIVE SPECTRAL POWER DISTRIBUTION, STANDARD LEDs

The following graphs are the result of a series of pulsed measurements at 700 mA for the 18-V CMB1510 and 350 mA for the 36-V CMB1510 and  $T_j = 85\text{ }^\circ\text{C}$ .

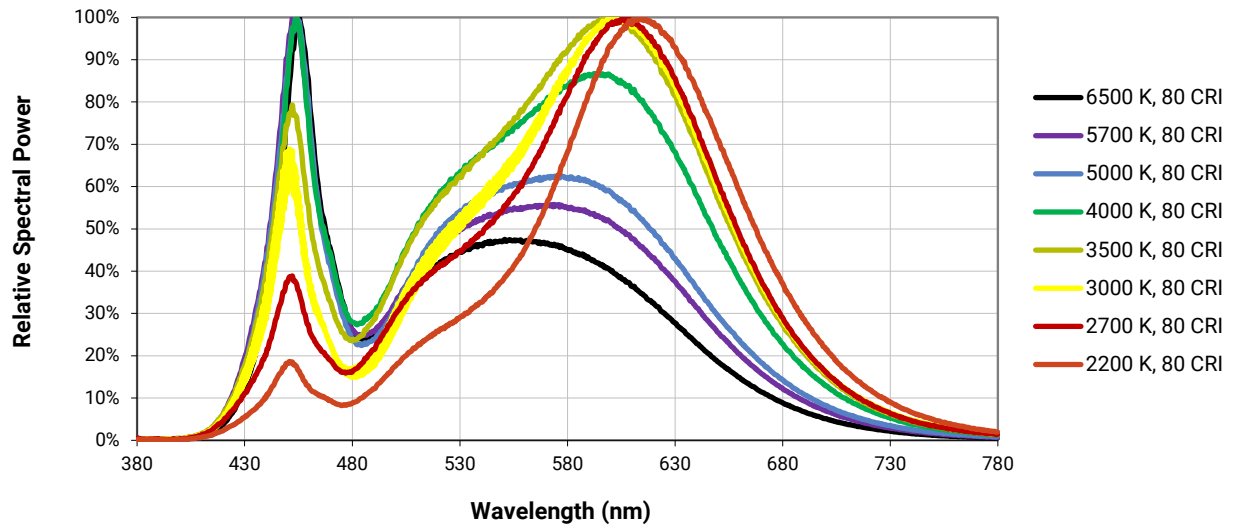
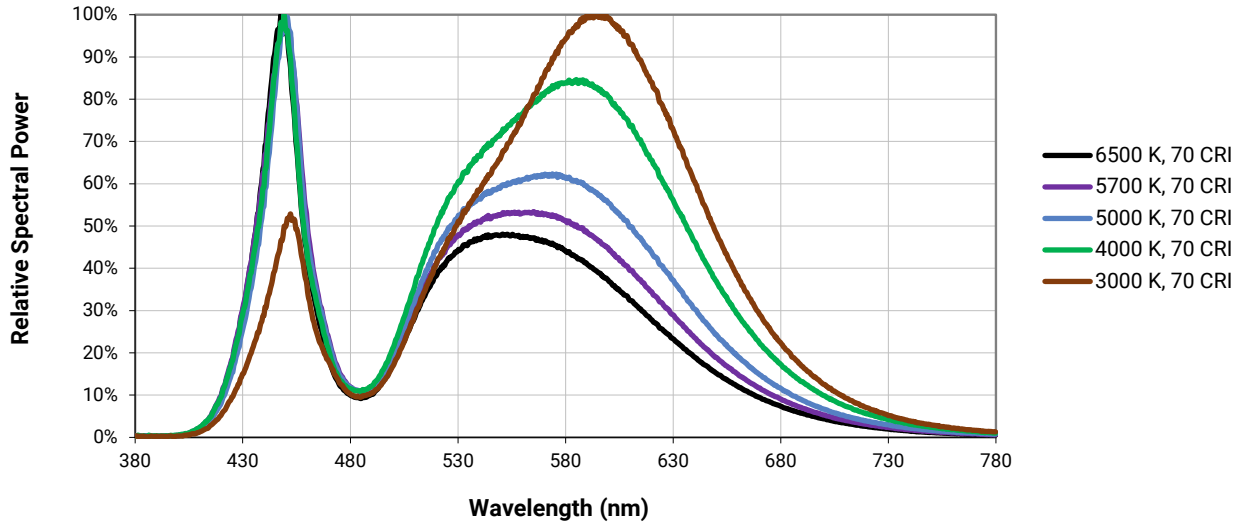

RELATIVE SPECTRAL POWER DISTRIBUTION, STANDARD LEDS - CONTINUED

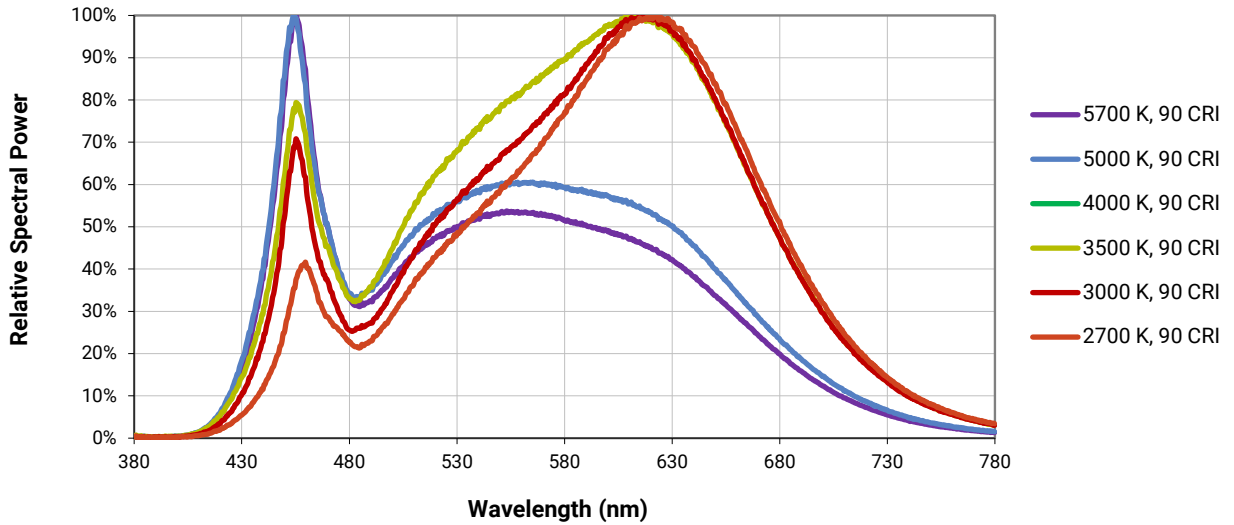

RELATIVE SPECTRAL POWER DISTRIBUTION, PREMIUM COLOR LEDS

The following graphs are the result of a series of pulsed measurements at 700 mA for the 18-V CMB1510 and 350 mA for the 36-V CMB1510 and  $T_J = 85^\circ\text{C}$ .

Fidelity

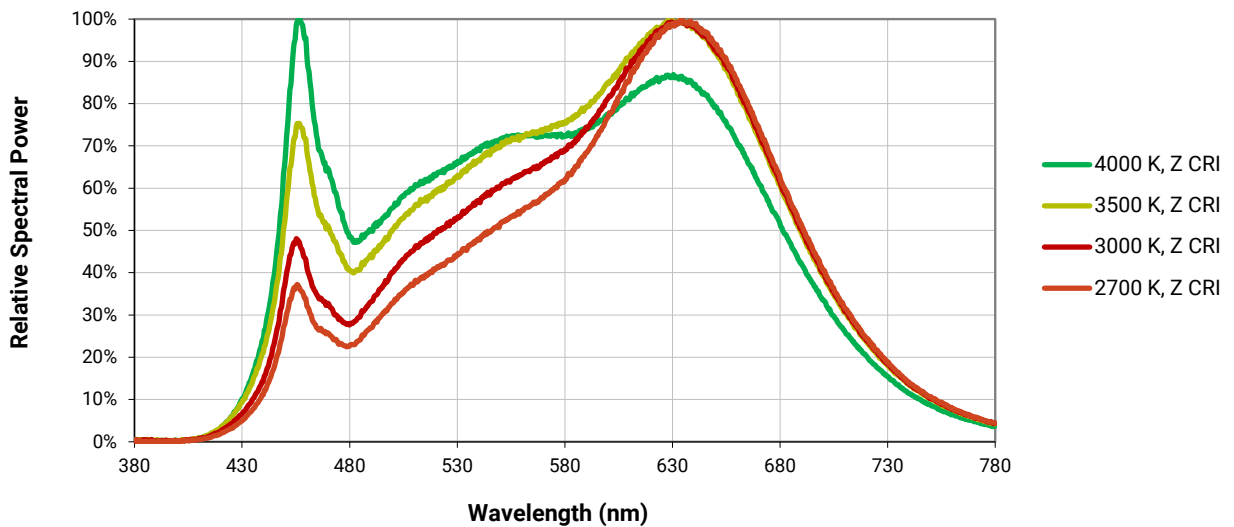

RELATIVE SPECTRAL POWER DISTRIBUTION, PREMIUM COLOR LEDS - CONTINUED

Specialty

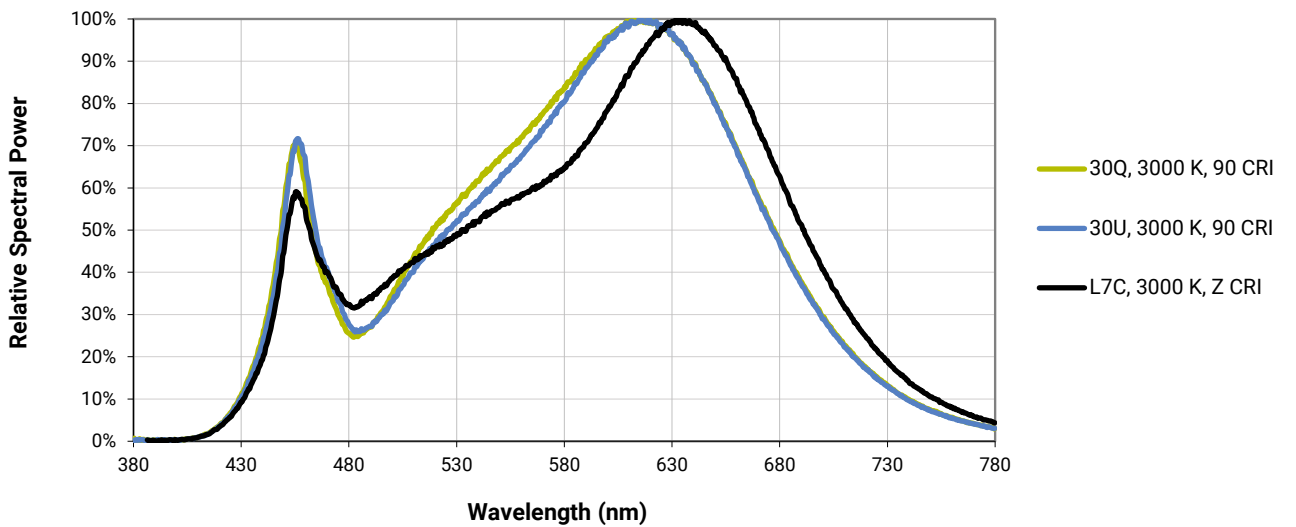
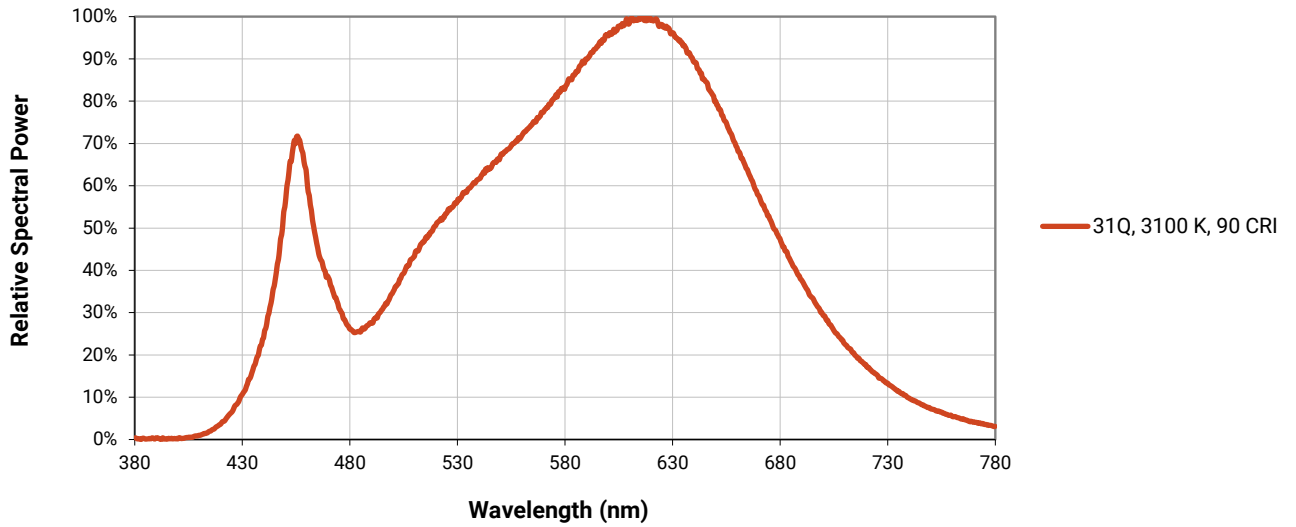

## ELECTRICAL CHARACTERISTICS

The following graphs are the result of a series of steady-state measurements.

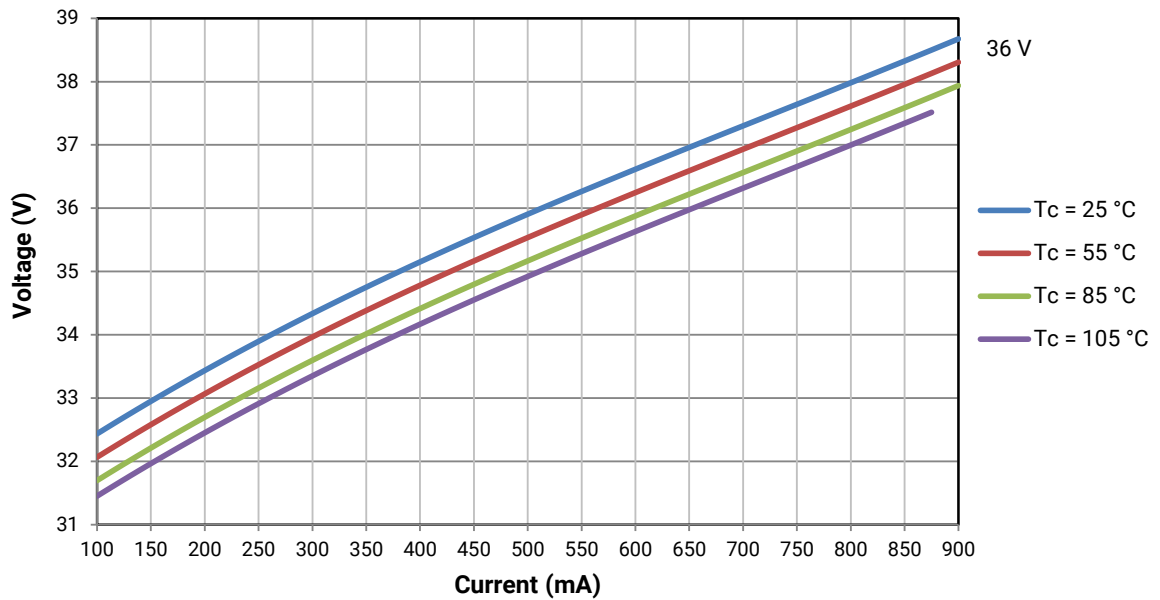
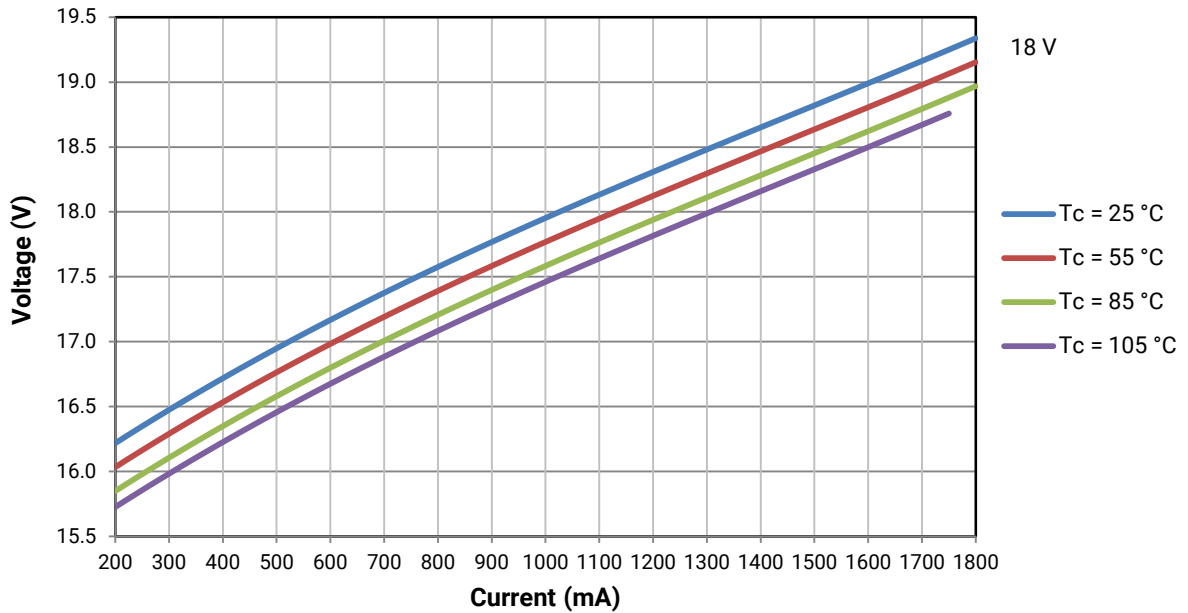

## RELATIVE LUMINOUS FLUX

The relative luminous flux values provided below are the ratio of:

- Measurements of CMB1510 at steady-state operation at the given conditions, divided by
- Flux measured during binning, which is a pulsed measurement at 700 mA at  $T_j = 85\text{ }^\circ\text{C}$ .

For example, at steady-state operation of  $T_c = 25\text{ }^\circ\text{C}$ ,  $I_f = 1000\text{ mA}$ , the relative luminous flux ratio is 150% in the chart below. A CMB1510 LED that measures 2050 lm during binning will deliver 3075 lm ( $2050 \times 1.5$ ) at steady-state operation of  $T_c = 25\text{ }^\circ\text{C}$ ,  $I_f = 1000\text{ mA}$ .

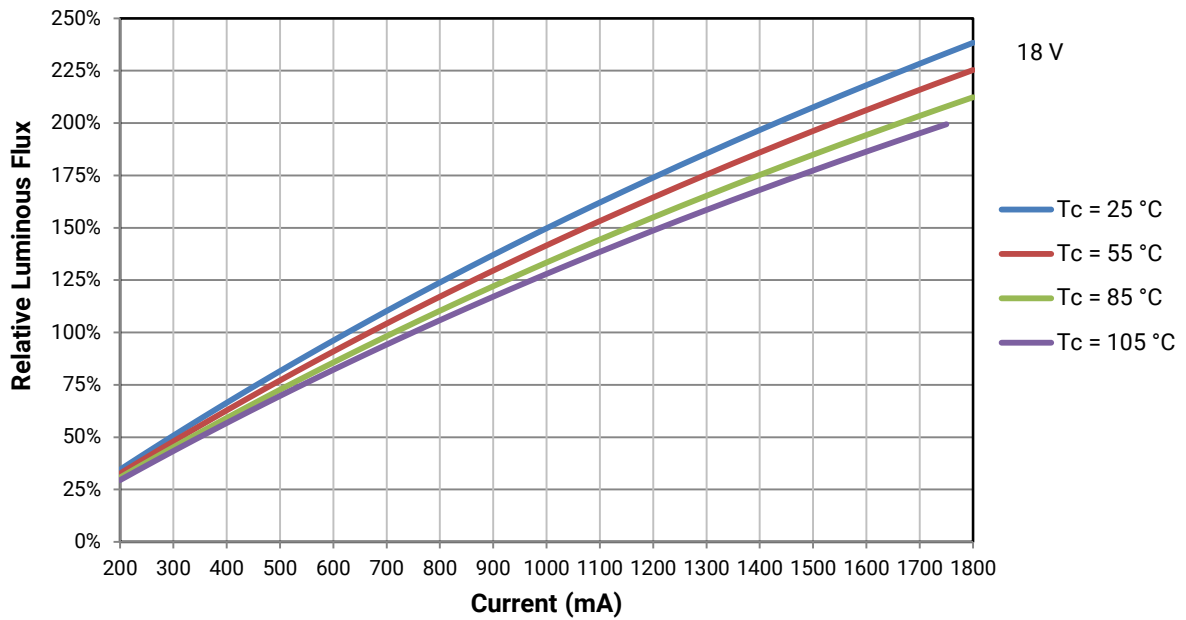

## RELATIVE LUMINOUS FLUX - CONTINUED

The relative luminous flux values provided below are the ratio of:

- Measurements of CMB1510 at steady-state operation at the given conditions, divided by
- Flux measured during binning, which is a pulsed measurement at 350 mA at  $T_j = 85\text{ }^\circ\text{C}$ .

For example, at steady-state operation of  $T_c = 25\text{ }^\circ\text{C}$ ,  $I_f = 500\text{ mA}$ , the relative luminous flux ratio is 150% in the chart below. A CMB1510 LED that measures 2050 lm during binning will deliver 3075 lm ( $2050 \times 1.5$ ) at steady-state operation of  $T_c = 25\text{ }^\circ\text{C}$ ,  $I_f = 500\text{ mA}$ .

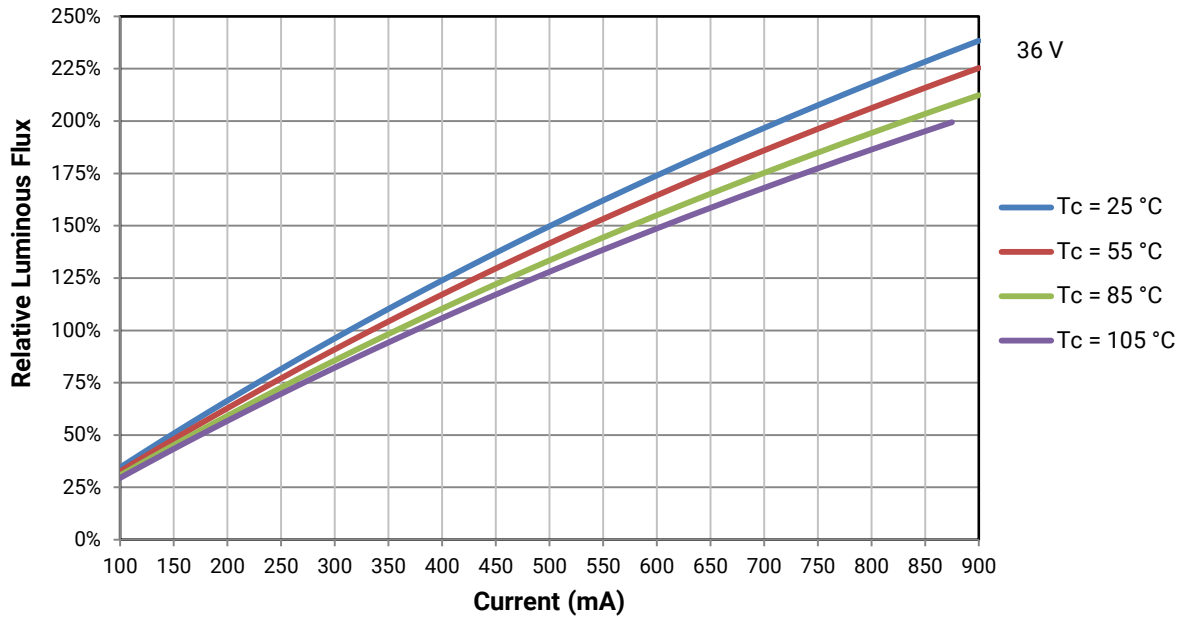

## TYPICAL SPATIAL DISTRIBUTION

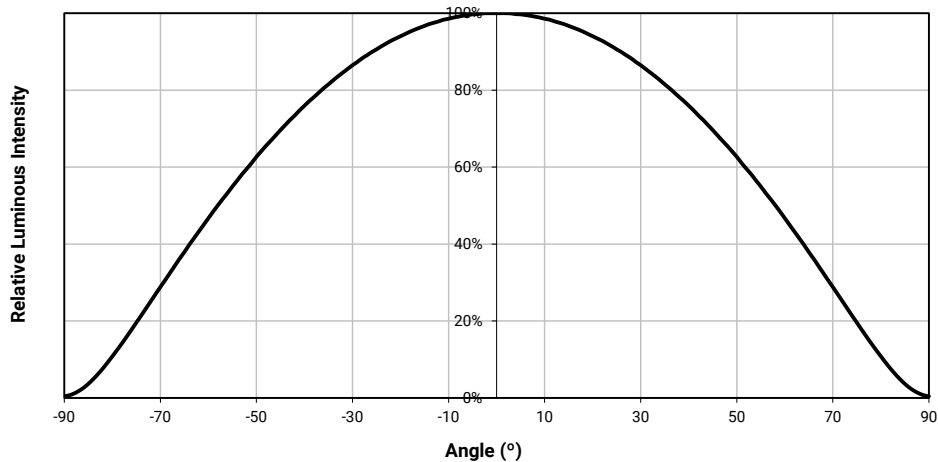

**EASYWHITE® PERFORMANCE GROUPS - CHROMATICITY ( $T_j = 85\text{ °C}$ )**

XLamp CMB1510 LEDs are tested for chromaticity and placed into one of the regions defined by the following bounding coordinates.

EasyWhite Color Temperatures – 2-Step			
Code	CCT	x	y
40H	4000 K	0.3764	0.3711
		0.3784	0.3787
		0.3847	0.3826
		0.3825	0.3748
35H	3500 K	0.4022	0.3858
		0.4053	0.3942
		0.4125	0.3977
		0.4091	0.3891
30H	3000 K	0.4287	0.3975
		0.4328	0.4064
		0.4390	0.4086
		0.4347	0.3996
27H	2700 K	0.4524	0.4048
		0.4574	0.4140
		0.4633	0.4154
		0.4581	0.4062

EasyWhite Color Temperatures – 3-Step Ellipse						
Bin Code	CCT	Center Point		Major Axis	Minor Axis	Rotation Angle (°)
		x	y	a	b	
57G	5700 K	0.3287	0.3417	0.00738	0.00360	72.0
50G	5000 K	0.3447	0.3553	0.00840	0.00312	65.0
40G	4000 K	0.3818	0.3797	0.00939	0.00402	53.7
35G	3500 K	0.4073	0.3917	0.00927	0.00414	54.0
30G	3000 K	0.4338	0.4030	0.00834	0.00408	53.2
27G	2700 K	0.4577	0.4099	0.00834	0.00420	48.5
22G	2200 K	0.5066	0.4158	0.00980	0.00480	45.5

EasyWhite Color Temperatures – 5-Step Ellipse						
Bin Code	CCT	Center Point		Major Axis	Minor Axis	Rotation Angle (°)
		x	y	a	b	
65E	6500 K	0.3123	0.3282	0.01110	0.00550	61.0
57E	5700 K	0.3287	0.3417	0.01230	0.00600	72.0
50E	5000 K	0.3447	0.3553	0.01400	0.00520	65.0
40E	4000 K	0.3818	0.3797	0.01565	0.00670	53.7
30E	3000 K	0.4338	0.4030	0.01390	0.00680	53.2

**PREMIUM COLOR PERFORMANCE GROUPS - CHROMATICITY ( $T_j = 85\text{ }^\circ\text{C}$ )**

XLamp CMB1510 LEDs are tested for chromaticity and placed into one of the regions defined by the following bounding coordinates.

**Fidelity**

EasyWhite Color Temperatures – 2-Step			
Code	CCT	x	y
40H	4000 K	0.3764	0.3711
		0.3784	0.3787
		0.3847	0.3826
		0.3825	0.3748
35H	3500 K	0.4022	0.3858
		0.4053	0.3942
		0.4125	0.3977
		0.4091	0.3891
30H	3000 K	0.4287	0.3975
		0.4328	0.4064
		0.4390	0.4086
		0.4347	0.3996
27H	2700 K	0.4524	0.4048
		0.4574	0.4140
		0.4633	0.4154
		0.4581	0.4062

**Specialty**

EasyWhite Color Temperatures – 2-Step			
Code	CCT	x	y
L7C	3000 K	0.4192	0.3754
		0.4224	0.3823
		0.4291	0.3847
		0.4257	0.3777

EasyWhite Color Temperatures – 3-Step Ellipse						
Bin Code	CCT	Center Point		Major Axis	Minor Axis	Rotation Angle (°)
		x	y	a	b	
31Q	3100 K	0.4236	0.3888	0.00848	0.00455	50.3
30Q	3000 K	0.4305	0.3935	0.00834	0.00408	53.2
30U	3000 K	0.4274	0.3837	0.00834	0.00408	53.2



EASYWHITE® BINS PLOTTED ON THE 1931 CIE COLOR SPACE ( $T_j = 85\text{ }^\circ\text{C}$ )

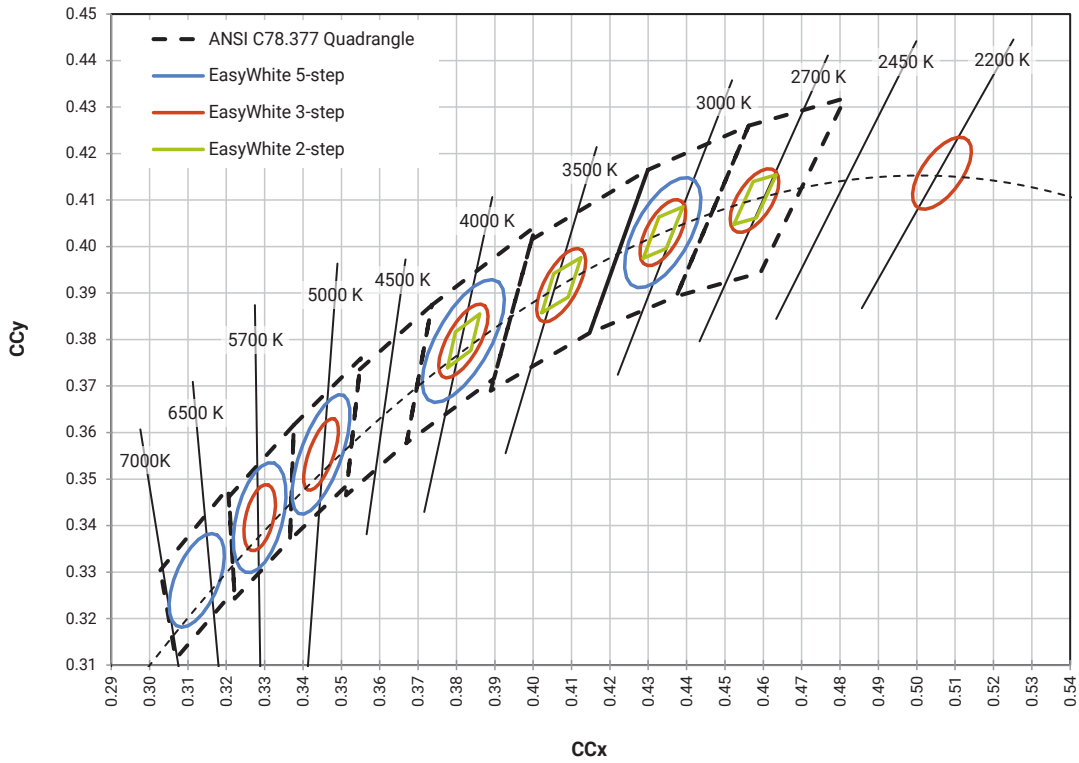

PREMIUM COLOR BINS PLOTTED ON THE 1931 CIE COLOR SPACE ( $T_j = 85\text{ }^\circ\text{C}$ )

Fidelity (2-step)

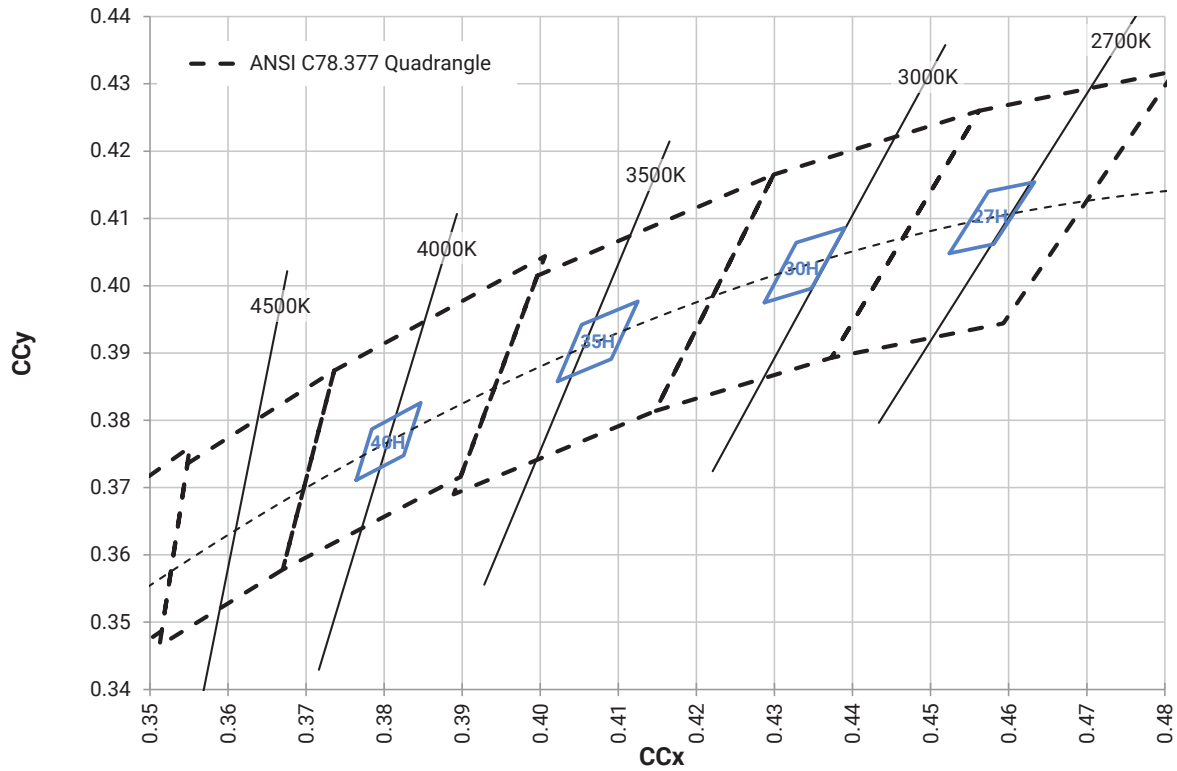

PREMIUM COLOR BINS PLOTTED ON THE 1931 CIE COLOR SPACE ( $T_j = 85^\circ\text{C}$ ) - CONTINUED

Specialty (2-step)

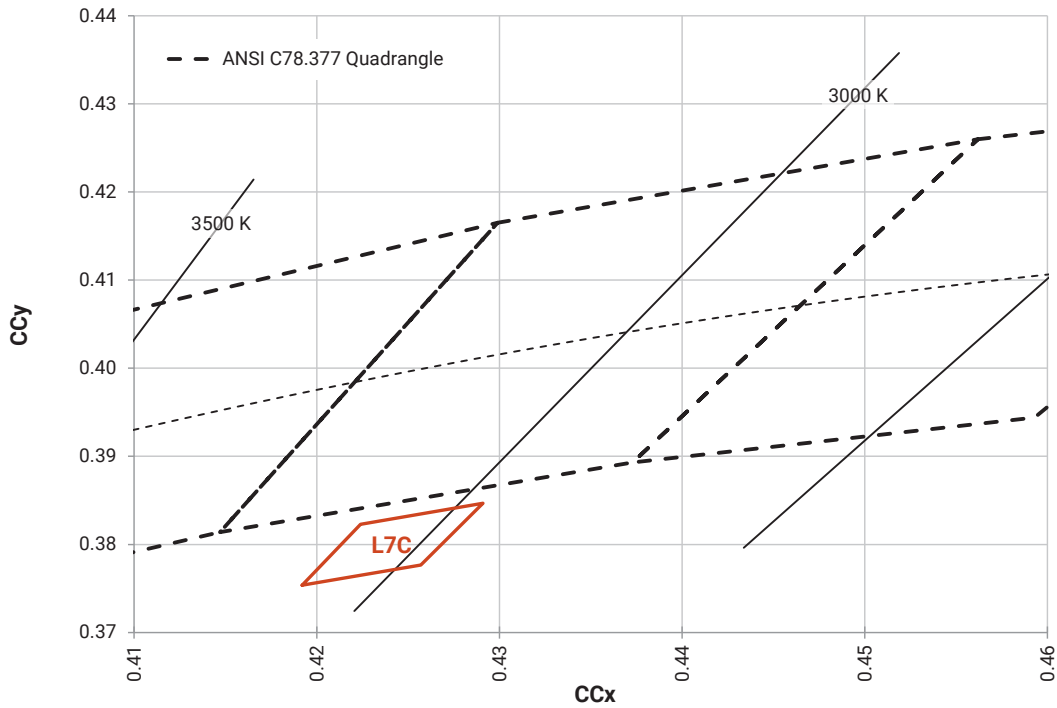

Specialty (3-step)

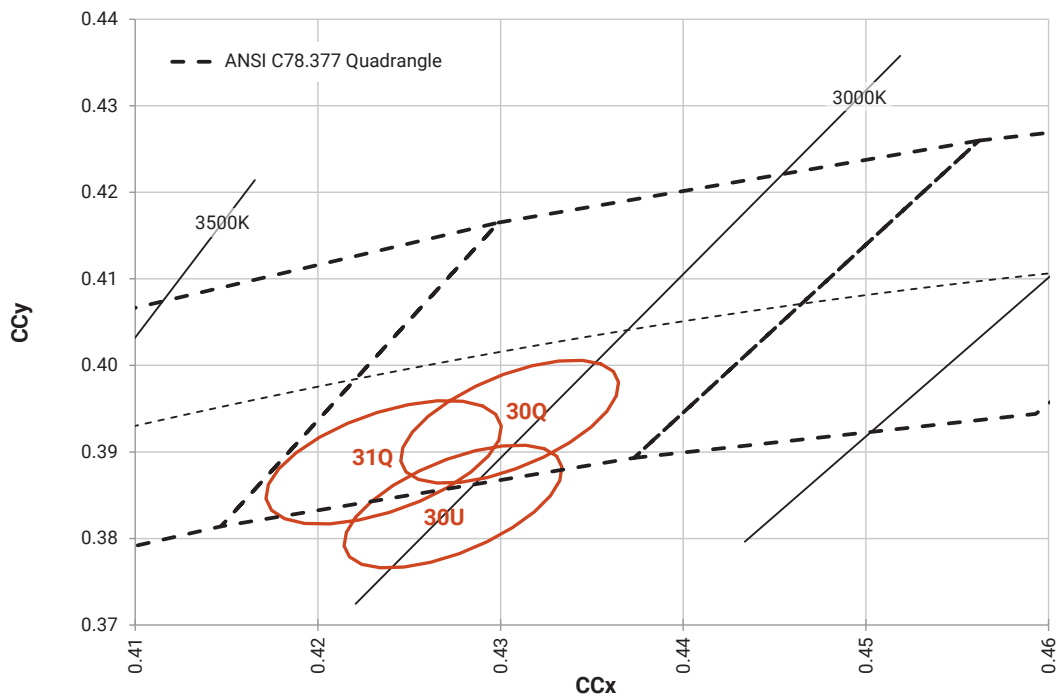

## BIN AND ORDER CODE FORMATS

Bin codes and order codes are configured as follows:

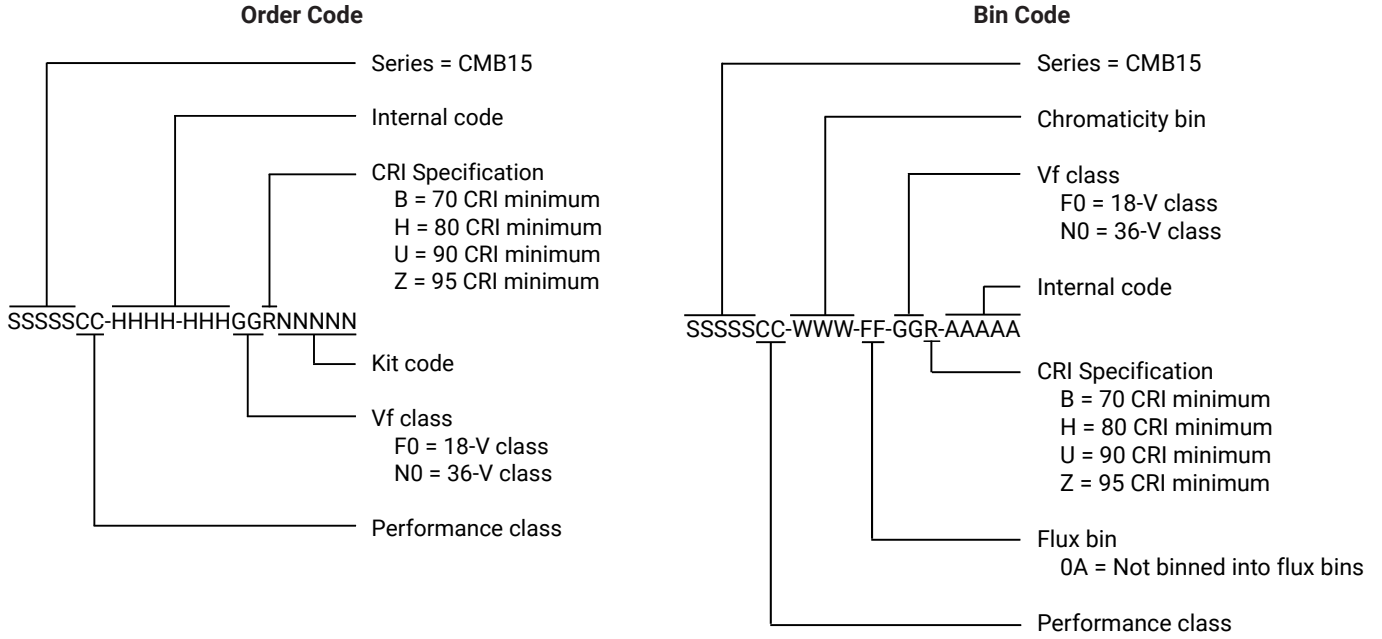



## THERMAL DESIGN

The CMB family of LED arrays can include over a hundred different LED die inside one package, and thus over a hundred different junction temperatures ( $T_j$ ). Cree LED has intentionally removed junction-temperature-based operating limits and replaced the commonplace maximum  $T_j$  calculations with maximum ratings based on forward current ( $I_f$ ) and case temperature ( $T_c$ ). No additional calculations are required to ensure that the CMB LED is being operated within its designed limits. LES temperature measurement provides additional verification of good thermal design. Please refer to page 3 for the Operating Limit specifications.

There is no need to calculate for  $T_j$  inside the package, as the thermal management design process, specifically from solder point ( $T_{sp}$ ) to ambient ( $T_a$ ), remains identical to any other LED component. For more information on thermal management of XLamp LEDs, please refer to the [Thermal Management application note](#). For CMB soldering recommendations and more information on thermal interface materials (TIM), LES temperature measurement, and connection methods, please refer to the [XLamp CM Family LEDs soldering and handling document](#).

To keep the CMB1510 LED at or below the maximum rated  $T_c$ , the case to ambient temperature thermal resistance ( $R_{c-a}$ ) must be at or below the maximum  $R_{c-a}$  value shown on the following graphs, depending on the operating environment. The y-axis in the graphs is a base 10 logarithmic scale.

As the figure at right shows, the  $R_{c-a}$  value is the sum of the thermal resistance of the TIM ( $R_{tim}$ ) plus the thermal resistance of the heat sink ( $R_{hs}$ ).

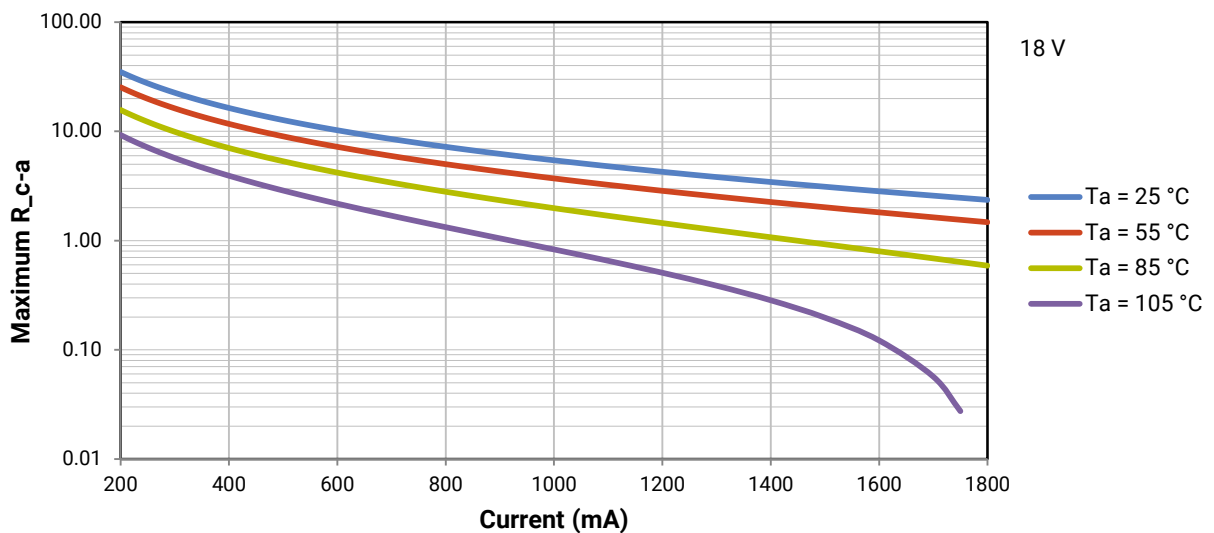
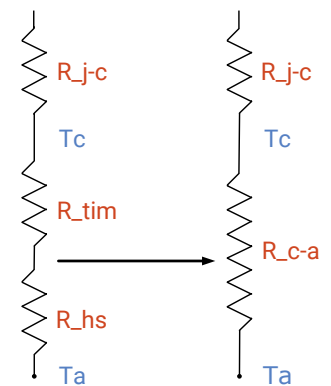

THERMAL DESIGN - CONTINUED

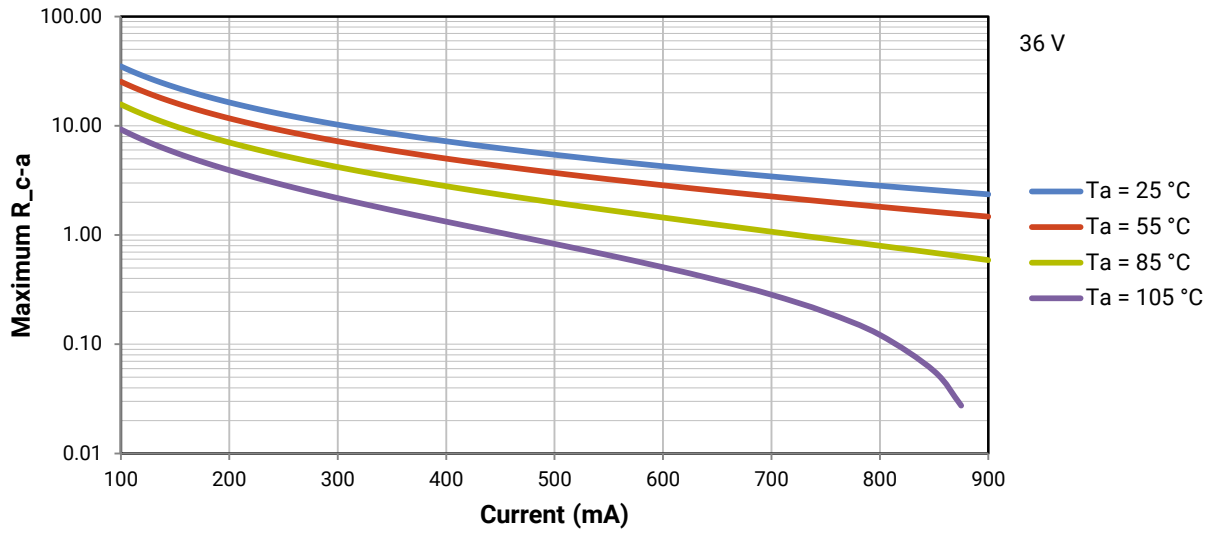

## NOTES

---

### Measurements

The luminous flux, radiant power, chromaticity, forward voltage and CRI measurements in this document are binning specifications only and solely represent product measurements as of the date of shipment. These measurements will change over time based on a number of factors that are not within Cree LED's control and are not intended or provided as operational specifications for the products. Calculated values are provided for informational purposes only and are not intended or provided as specifications.

### Pre-Release Qualification Testing

Please read the [LED Reliability Overview](#) for details of the qualification process Cree LED applies to ensure long-term reliability for XLamp LEDs and details of Cree LED's pre-release qualification testing for XLamp LEDs. Cree LED did not perform Room Temperature Operating Life (RTOL) testing on the CMB1510 LED.

### Lumen Maintenance

Cree LED now uses standardized IES LM-80-08 and TM-21-11 methods for collecting long-term data and extrapolating LED lumen maintenance. For information on the specific LM-80 data sets available for this LED, refer to the public [LM-80 results document](#).

Please read the [Long-Term Lumen Maintenance application note](#) for more details on Cree LED's lumen maintenance testing and forecasting. Please read the [Thermal Management application note](#) for details on how thermal design, ambient temperature, and drive current affect the LED junction temperature.

### RoHS Compliance

The levels of RoHS restricted materials in this product are below the maximum concentration values (also referred to as the threshold limits) permitted for such substances, or are used in an exempted application, in accordance with EU Directive 2011/65/EC (RoHS2), as implemented January 2, 2013. RoHS Declarations for this product can be obtained from your Cree LED representative or from the [Product Ecology](#) section of the Cree LED website.

### REACH Compliance

REACH substances of very high concern (SVHCs) information is available for this product. Since the European Chemical Agency (ECHA) has published notice of their intent to frequently revise the SVHC listing for the foreseeable future, please contact a Cree LED representative to insure you get the most up-to-date REACH SVHC Declaration. REACH banned substance information (REACH Article 67) is also available upon request.

### UL® Recognized Component

This product meets the requirements to be considered a UL Recognized Component with Level 4 enclosure consideration. The LED package or a portion thereof has been investigated as a fire and electrical enclosure per ANSI/UL 8750.

### Vision Advisory

WARNING: Do not look at an exposed lamp in operation. Eye injury can result. For more information about LEDs and eye safety, please refer to the [LED Eye Safety application note](#).



**PACKAGING**

CMB1510 LEDs are packaged in trays of 54. Five trays are sealed in an anti-static bag and placed inside an inner box, for a total of 270 LEDs per box. Each box contains LEDs from the same performance bin. Eight boxes are placed inside a carton, for a total of 2,160 LEDs per carton.

Dimensions are in mm.  
Tolerance: ± 0.5 mm.

Load Tray

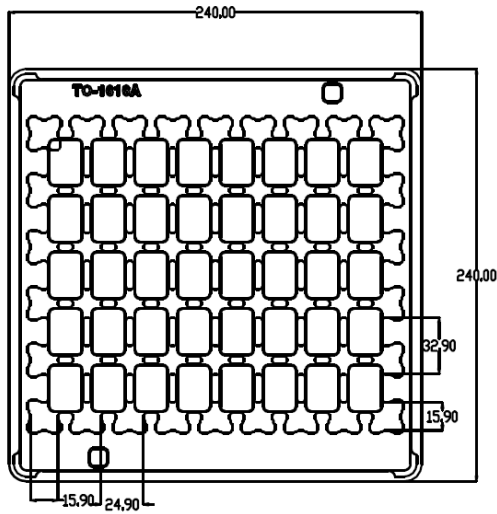

Upper Tray

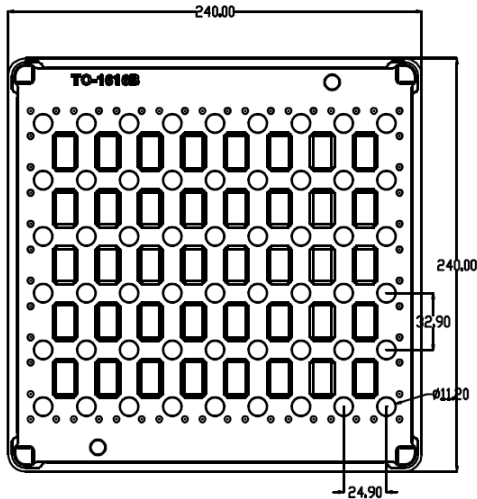

PACKAGING - CONTINUED

CMB1510 LEDs are packaged in trays of 54. Five trays are sealed in an anti-static bag and placed inside an inner box, for a total of 270 LEDs per box. Each box contains LEDs from the same performance bin. Eight boxes are placed inside a carton, for a total of 2,160 LEDs per carton.

Dimensions are in mm.  
Tolerance: ± 3 mm

Inner Box

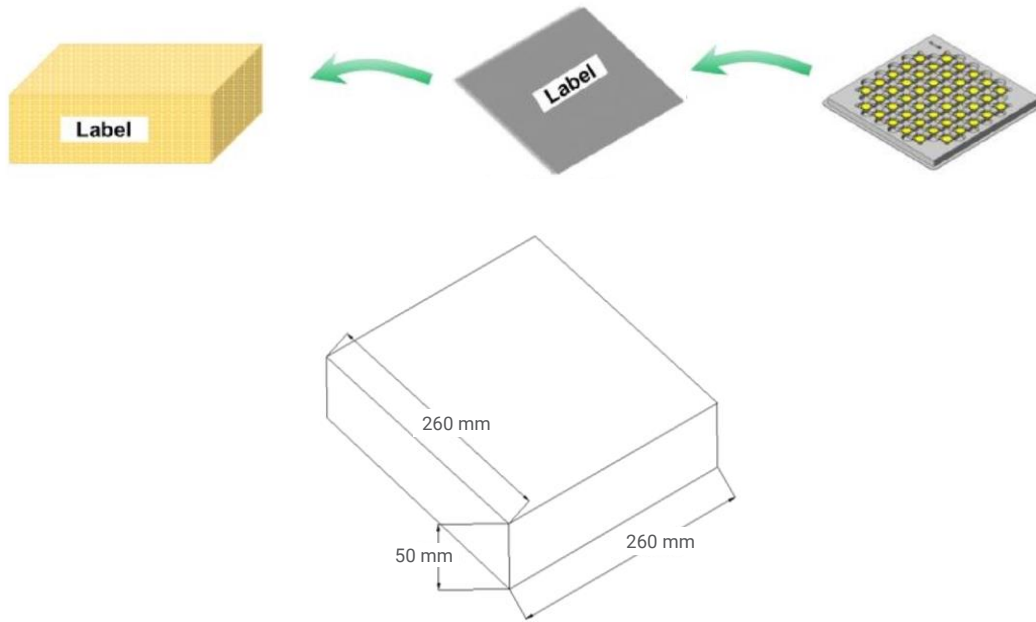

Outer Carton

