

XLamp® XD16 Premium White LEDs

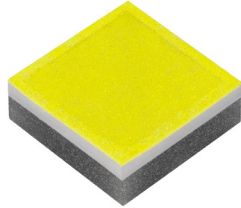

PRODUCT DESCRIPTION

The XLamp® XD16 LEDs are the industry’s first Extreme Density LEDs, delivering up to 5½ times higher lumen density than Cree LED’s previous generation of high-power LEDs. The ceramic based XD16 LED package addresses challenges with luminaire manufacturing, thermal design, optical design and reliability that have been experienced with competing LEDs.

XD16 LEDs are available in two versions: Standard and Premium White. The Standard version is optimized for tightly-packed arrays of multiple LEDs. The Premium White version upgrades the optical profile of the LED to work well with secondary optics and reduce cross talk between LEDs.

XLamp XD16 LEDs are optimized for all lighting applications that require extreme levels of lumen density, including indoor directional, portable and aftermarket automotive.

FEATURES

- Available in outdoor white and 70-, 80- and 90-CRI white
- ANSI-compatible chromaticity bins
- 3-step and 5-step options
- Binned at 85 °C
- Maximum drive current: 2 A
- Low thermal resistance: 1.8 °C/W
- Wide viewing angle: 120°
- Unlimited floor life at ≤ 30 °C/85% RH
- Reflow solderable - JEDEC J-STD-020C
- UL® recognized component (E349212)

TABLE OF CONTENTS

Characteristics	2
Flux Characteristics	3
Relative Spectral Power Distribution	12
Relative Flux vs. Junction Temperature.....	12
Electrical Characteristics.....	13
Relative Flux vs. Current	13
Relative Chromaticity vs. Current and Temperature	14
Typical Spatial Distribution.....	15
Thermal Design	15
Performance Groups - Luminous Flux.....	16
Performance Groups - Chromaticity	16
Cool White Kits Plotted on ANSI Standard Chromaticity Regions	19
Warm and Neutral White Kits Plotted on ANSI Standard Chromaticity Regions	20
Warm White Kits Plotted on ANSI Standard Chromaticity Regions	21
EasyWhite® White Kits Plotted on ANSI Standard Chromaticity Regions	21
Standard Chromaticity Kits	22
Bin and Order Code Formats.....	23
Reflow Soldering Characteristics.....	24
Notes	25
Mechanical Dimensions	26
Tape and Reel.....	28
Packaging.....	30



Cree LED / 4001 E. Hwy. 54, Suite 2000 / Durham, NC 27709 USA / +1.919.313.5330 / www.cree-led.com

CHARACTERISTICS

Characteristics	Unit	Minimum	Typical	Maximum
Thermal resistance, junction to solder point ⁹	°C/W		1.8	
Viewing angle (FWHM)	degrees		120	
Temperature coefficient of voltage	mV/°C		-1.3	
DC forward current	mA			2000
Reverse voltage	V			1
Forward voltage (@ 350 mA, 85 °C)	V		2.73	3
Forward voltage (@ 700 mA, 85 °C)	V		2.82	
Forward voltage (@ 1000 mA, 85 °C)	V		2.88	
Forward voltage (@ 1500 mA, 85 °C)	V		2.97	
LED junction temperature	°C			150

Notes:

- ◇ Thermal resistance measurement was performed per the JEDEC JESD51-14 standard. See the [Thermal Resistance Measurement application note](#) for more details.

FLUX CHARACTERISTICS (T_J = 85 °C)

The following table provides order codes for XLamp XD16 Premium White LEDs. For a complete description of the order code nomenclature, please see the Bin and Order Code Formats section (page 23). For definitions of the chromaticity kits, please see the Standard Chromaticity Kits section (page 22).

Chromaticity		Minimum Luminous Flux (lm) @ 350 mA			Calculated Minimum Luminous Flux (lm) @ 85 °C**		Order Codes			
Kit	CCT	Code	Flux (lm) @ 85 °C	Flux (lm) @ 25 °C*	700 mA	1.0 A	No Minimum CRI	70 CRI Minimum	80 CRI Minimum	90 CRI Minimum
DT	7000 K	S2	148	161	272	366	XD16AWT-P0-0000-000000JDT	XD16AWT-P0-0000-000000BJDT	XD16AWT-P0-0000-000000HJDT	
		R5	139	151	256	344	XD16AWT-P0-0000-000000HDT	XD16AWT-P0-0000-000000BHDT	XD16AWT-P0-0000-000000HHDT	
		R4	130	141	239	322			XD16AWT-P0-0000-000000HGDT	
E1	6500 K	S2	148	161	272	366	XD16AWT-P0-0000-000000JE1	XD16AWT-P0-0000-000000BJE1	XD16AWT-P0-0000-000000HJE1	
		R5	139	151	256	344	XD16AWT-P0-0000-000000HE1	XD16AWT-P0-0000-000000BHE1	XD16AWT-P0-0000-000000HHE1	
		R4	130	141	239	322			XD16AWT-P0-0000-000000HGE1	
50	6200 K	S3	156	169	287	386	XD16AWT-P0-0000-000000K50			
		S2	148	161	272	366	XD16AWT-P0-0000-000000J50		XD16AWT-P0-0000-000000HJ50	
		R5	139	151	256	344	XD16AWT-P0-0000-000000H50		XD16AWT-P0-0000-000000HH50	
		R4	130	141	239	322			XD16AWT-P0-0000-000000HG50	
DV	6000 K	S3	156	169	287	386	XD16AWT-P0-0000-000000KDV	XD16AWT-P0-0000-000000BKDV		
		S2	148	161	272	366	XD16AWT-P0-0000-000000JDV	XD16AWT-P0-0000-000000BJDV	XD16AWT-P0-0000-000000HJDV	
		R5	139	151	256	344	XD16AWT-P0-0000-000000HDV	XD16AWT-P0-0000-000000BHDV	XD16AWT-P0-0000-000000HHDV	
		R4	130	141	239	322			XD16AWT-P0-0000-000000HGDV	
		R3	122	132	225	302				XD16AWT-P0-0000-000000UFDV
		R2	114	124	210	282				XD16AWT-P0-0000-000000UEDV

Notes

- Cree LED maintains a tolerance of ±7% on flux and power measurements, ±0.005 on chromaticity (CCx, CCy) measurements and a tolerance of ±2 on CRI measurements. See the Measurements section (page 25).
- XLamp XD16 LED order codes specify only a minimum flux bin and not a maximum. Cree LED may ship reels in flux bins higher than the minimum specified by the order code without advance notice. Shipments will always adhere to the chromaticity bin restrictions specified by the order code.
- * Flux values @ 25 °C are calculated and for reference only.
- ** Flux values @ 700 mA and 1.0 A are calculated and for reference only.

FLUX CHARACTERISTICS (T_J = 85 °C) - CONTINUED

Chromaticity		Minimum Luminous Flux (lm) @ 350 mA			Calculated Minimum Luminous Flux (lm) @ 85 °C**		Order Codes			
Kit	CCT	Code	Flux (lm) @ 85 °C	Flux (lm) @ 25 °C*	700 mA	1.0 A	No Minimum CRI	70 CRI Minimum	80 CRI Minimum	90 CRI Minimum
E2	5700 K	S3	156	169	287	386	XD16AWT-P0-0000-000000KE2	XD16AWT-P0-0000-00000BKE2		
		S2	148	161	272	366	XD16AWT-P0-0000-000000JE2	XD16AWT-P0-0000-00000BJE2	XD16AWT-P0-0000-00000HJE2	
		R5	139	151	256	344	XD16AWT-P0-0000-000000HE2	XD16AWT-P0-0000-00000BHE2	XD16AWT-P0-0000-00000HHE2	
		R4	130	141	239	322			XD16AWT-P0-0000-00000HGE2	
		R3	122	132	225	302				XD16AWT-P0-0000-00000UFE2
		R2	114	124	210	282				XD16AWT-P0-0000-00000UEE2
2E	5700 K	S3	156	169	287	386		XD16AWT-P0-0000-00000BK2E		
		S2	148	161	272	366		XD16AWT-P0-0000-00000BJ2E	XD16AWT-P0-0000-00000HJ2E	
		R5	139	151	256	344		XD16AWT-P0-0000-00000BH2E	XD16AWT-P0-0000-00000HH2E	
		R4	130	141	239	322			XD16AWT-P0-0000-00000HG2E	
		R3	122	132	225	302				XD16AWT-P0-0000-00000UF2E
		R2	114	124	210	282				XD16AWT-P0-0000-00000UE2E
3E	5000 K	S3	156	169	287	386		XD16AWT-P0-0000-00000BK3E		
		S2	148	161	272	366		XD16AWT-P0-0000-00000BJ3E		
		R5	139	151	256	344		XD16AWT-P0-0000-00000BH3E	XD16AWT-P0-0000-00000HH3E	
		R4	130	141	239	322			XD16AWT-P0-0000-00000HG3E	
		R3	122	132	225	302			XD16AWT-P0-0000-00000HF3E	XD16AWT-P0-0000-00000UF3E
		R2	114	124	210	282				XD16AWT-P0-0000-00000UE3E

Notes

- Cree LED maintains a tolerance of ±7% on flux and power measurements, ±0.005 on chromaticity (CCx, CCy) measurements and a tolerance of ±2 on CRI measurements. See the Measurements section (page 25).
- XLamp XD16 LED order codes specify only a minimum flux bin and not a maximum. Cree LED may ship reels in flux bins higher than the minimum specified by the order code without advance notice. Shipments will always adhere to the chromaticity bin restrictions specified by the order code.
- * Flux values @ 25 °C are calculated and for reference only.
- ** Flux values @ 700 mA and 1.0 A are calculated and for reference only.

FLUX CHARACTERISTICS (T_j = 85 °C) - CONTINUED

Chromaticity		Minimum Luminous Flux (lm) @ 350 mA			Calculated Minimum Luminous Flux (lm) @ 85 °C**		Order Codes			
Kit	CCT	Code	Flux (lm) @ 85 °C	Flux (lm) @ 25 °C*	700 mA	1.0 A	No Minimum CRI	70 CRI Minimum	80 CRI Minimum	90 CRI Minimum
E3	5000 K	S3	156	169	287	386	XD16AWT-P0-0000-000000KE3	XD16AWT-P0-0000-000000BKE3		
		S2	148	161	272	366	XD16AWT-P0-0000-000000JE3	XD16AWT-P0-0000-000000BJE3		
		R5	139	151	256	344	XD16AWT-P0-0000-000000HE3	XD16AWT-P0-0000-000000BHE3	XD16AWT-P0-0000-000000HHE3	
		R4	130	141	239	322			XD16AWT-P0-0000-000000HGE3	
		R3	122	132	225	302			XD16AWT-P0-0000-000000HFE3	XD16AWT-P0-0000-000000UFE3
		R2	114	124	210	282				XD16AWT-P0-0000-000000UEE3
F4	4750K	S3	156	169	287	386	XD16AWT-P0-0000-000000KF4	XD16AWT-P0-0000-000000BKF4		
		S2	148	161	272	366	XD16AWT-P0-0000-000000JF4	XD16AWT-P0-0000-000000BJF4		
		R5	139	151	256	344	XD16AWT-P0-0000-000000HF4	XD16AWT-P0-0000-000000BHF4	XD16AWT-P0-0000-000000HHF4	
		R4	130	141	239	322			XD16AWT-P0-0000-000000HGF4	
		R3	122	132	225	302			XD16AWT-P0-0000-000000HFF4	XD16AWT-P0-0000-000000UFF4
		R2	114	124	210	282				XD16AWT-P0-0000-000000UEF4
4E	4500K	S3	156	169	287	386		XD16AWT-P0-0000-000000BK4E		
		S2	148	161	272	366		XD16AWT-P0-0000-000000BJ4E		
		R5	139	151	256	344		XD16AWT-P0-0000-000000BH4E	XD16AWT-P0-0000-000000HH4E	
		R4	130	141	239	322			XD16AWT-P0-0000-000000HG4E	
		R3	122	132	225	302			XD16AWT-P0-0000-000000HF4E	XD16AWT-P0-0000-000000UF4E
		R2	114	124	210	282				XD16AWT-P0-0000-000000UE4E
		Q5	107	116	197	265				XD16AWT-P0-0000-000000UD4E

Notes

- Cree LED maintains a tolerance of ±7% on flux and power measurements, ±0.005 on chromaticity (CCx, CCy) measurements and a tolerance of ±2 on CRI measurements. See the Measurements section (page 25).
- XLamp XD16 LED order codes specify only a minimum flux bin and not a maximum. Cree LED may ship reels in flux bins higher than the minimum specified by the order code without advance notice. Shipments will always adhere to the chromaticity bin restrictions specified by the order code.
- * Flux values @ 25 °C are calculated and for reference only.
- ** Flux values @ 700 mA and 1.0 A are calculated and for reference only.

FLUX CHARACTERISTICS (T_j = 85 °C) - CONTINUED

Chromaticity		Minimum Luminous Flux (lm) @ 350 mA			Calculated Minimum Luminous Flux (lm) @ 85 °C**		Order Codes			
Kit	CCT	Code	Flux (lm) @ 85 °C	Flux (lm) @ 25 °C*	700 mA	1.0 A	No Minimum CRI	70 CRI Minimum	80 CRI Minimum	90 CRI Minimum
E4	4500 K	S3	156	169	287	386	XD16AWT-P0-0000-000000KE4	XD16AWT-P0-0000-000000BKE4		
		S2	148	161	272	366	XD16AWT-P0-0000-000000JE4	XD16AWT-P0-0000-000000BJE4		
		R5	139	151	256	344	XD16AWT-P0-0000-000000HE4	XD16AWT-P0-0000-000000BHE4	XD16AWT-P0-0000-000000HHE4	
		R4	130	141	239	322			XD16AWT-P0-0000-000000HGE4	
		R3	122	132	225	302			XD16AWT-P0-0000-000000HFE4	XD16AWT-P0-0000-000000UFE4
		R2	114	124	210	282				XD16AWT-P0-0000-000000UEE4
		Q5	107	116	197	265				XD16AWT-P0-0000-000000UDE4
F5	4200 K	S3	156	169	287	386	XD16AWT-P0-0000-000000KF5	XD16AWT-P0-0000-000000BKF5		
		S2	148	161	272	366	XD16AWT-P0-0000-000000JF5	XD16AWT-P0-0000-000000BJF5		
		R5	139	151	256	344	XD16AWT-P0-0000-000000HF5	XD16AWT-P0-0000-000000BHF5	XD16AWT-P0-0000-000000HHF5	
		R4	130	141	239	322			XD16AWT-P0-0000-000000HGF5	
		R3	122	132	225	302			XD16AWT-P0-0000-000000HFF5	XD16AWT-P0-0000-000000UFF5
		R2	114	124	210	282				XD16AWT-P0-0000-000000UEF5
		Q5	107	116	197	265				XD16AWT-P0-0000-000000UDF5
5E	4000 K	S3	156	169	287	386		XD16AWT-P0-0000-000000BK5E		
		S2	148	161	272	366		XD16AWT-P0-0000-000000BJ5E		
		R5	139	151	256	344		XD16AWT-P0-0000-000000BH5E	XD16AWT-P0-0000-000000HH5E	
		R4	130	141	239	322			XD16AWT-P0-0000-000000HG5E	
		R3	122	132	225	302			XD16AWT-P0-0000-000000HF5E	XD16AWT-P0-0000-000000UF5E
		R2	114	124	210	282				XD16AWT-P0-0000-000000UE5E
		Q5	107	116	197	265				XD16AWT-P0-0000-000000UD5E

Notes

- Cree LED maintains a tolerance of ±7% on flux and power measurements, ±0.005 on chromaticity (CCx, CCy) measurements and a tolerance of ±2 on CRI measurements. See the Measurements section (page 25).
- XLamp XD16 LED order codes specify only a minimum flux bin and not a maximum. Cree LED may ship reels in flux bins higher than the minimum specified by the order code without advance notice. Shipments will always adhere to the chromaticity bin restrictions specified by the order code.
- * Flux values @ 25 °C are calculated and for reference only.
- ** Flux values @ 700 mA and 1.0 A are calculated and for reference only.

FLUX CHARACTERISTICS (T_j = 85 °C) - CONTINUED

Chromaticity		Minimum Luminous Flux (lm) @ 350 mA			Calculated Minimum Luminous Flux (lm) @ 85 °C**		Order Codes			
Kit	CCT	Code	Flux (lm) @ 85 °C	Flux (lm) @ 25 °C*	700 mA	1.0 A	No Minimum CRI	70 CRI Minimum	80 CRI Minimum	90 CRI Minimum
5G	4000 K	R5	139	151	256	344			XD16AWT-P0-0000-00000HH5G	
		R4	130	141	239	322			XD16AWT-P0-0000-00000HG5G	
		R3	122	132	225	302			XD16AWT-P0-0000-00000HF5G	XD16AWT-P0-0000-00000UF5G
		R2	114	124	210	282				XD16AWT-P0-0000-00000UE5G
		Q5	107	116	197	265				XD16AWT-P0-0000-00000UD5G
E5	4000 K	S3	156	169	287	386	XD16AWT-P0-0000-00000KE5	XD16AWT-P0-0000-00000BKE5		
		S2	148	161	272	366	XD16AWT-P0-0000-00000JE5	XD16AWT-P0-0000-00000BJE5		
		R5	139	151	256	344	XD16AWT-P0-0000-00000HE5	XD16AWT-P0-0000-00000BHE5	XD16AWT-P0-0000-00000HHE5	
		R4	130	141	239	322			XD16AWT-P0-0000-00000HGE5	
		R3	122	132	225	302			XD16AWT-P0-0000-00000HFE5	XD16AWT-P0-0000-00000UFE5
		R2	114	124	210	282				XD16AWT-P0-0000-00000UEE5
		Q5	107	116	197	265				XD16AWT-P0-0000-00000UDE5
F6	3700 K	S2	148	161	272	366	XD16AWT-P0-0000-00000JF6	XD16AWT-P0-0000-00000BJF6		
		R5	139	151	256	344	XD16AWT-P0-0000-00000HF6	XD16AWT-P0-0000-00000BHF6	XD16AWT-P0-0000-00000HHF6	
		R4	130	141	239	322			XD16AWT-P0-0000-00000HGF6	
		R3	122	132	225	302			XD16AWT-P0-0000-00000HFF6	
		R2	114	124	210	282				XD16AWT-P0-0000-00000UEF6
		Q5	107	116	197	265				XD16AWT-P0-0000-00000UDF6

Notes

- Cree LED maintains a tolerance of ±7% on flux and power measurements, ±0.005 on chromaticity (CCx, CCy) measurements and a tolerance of ±2 on CRI measurements. See the Measurements section (page 25).
- XLamp XD16 LED order codes specify only a minimum flux bin and not a maximum. Cree LED may ship reels in flux bins higher than the minimum specified by the order code without advance notice. Shipments will always adhere to the chromaticity bin restrictions specified by the order code.
- * Flux values @ 25 °C are calculated and for reference only.
- ** Flux values @ 700 mA and 1.0 A are calculated and for reference only.

FLUX CHARACTERISTICS (T_j = 85 °C) - CONTINUED

Chromaticity		Minimum Luminous Flux (lm) @ 350 mA			Calculated Minimum Luminous Flux (lm) @ 85 °C**		Order Codes			
Kit	CCT	Code	Flux (lm) @ 85 °C	Flux (lm) @ 25 °C*	700 mA	1.0 A	No Minimum CRI	70 CRI Minimum	80 CRI Minimum	90 CRI Minimum
6E	3500 K	S2	148	161	272	366		XD16AWT-P0-0000-00000BJ6E		
		R5	139	151	256	344		XD16AWT-P0-0000-00000BH6E	XD16AWT-P0-0000-00000HH6E	
		R4	130	141	239	322			XD16AWT-P0-0000-00000HG6E	
		R3	122	132	225	302			XD16AWT-P0-0000-00000HF6E	
		R2	114	124	210	282				XD16AWT-P0-0000-00000UE6E
		Q5	107	116	197	265				XD16AWT-P0-0000-00000UD6E
6G	3500 K	R5	139	151	256	344			XD16AWT-P0-0000-00000HH6G	
		R4	130	141	239	322			XD16AWT-P0-0000-00000HG6G	
		R3	122	132	225	302			XD16AWT-P0-0000-00000HF6G	
		R2	114	124	210	282				XD16AWT-P0-0000-00000UE6G
		Q5	107	116	197	265				XD16AWT-P0-0000-00000UD6G
E6	3500 K	S2	148	161	272	366	XD16AWT-P0-0000-00000JE6	XD16AWT-P0-0000-00000BJE6		
		R5	139	151	256	344	XD16AWT-P0-0000-00000HE6	XD16AWT-P0-0000-00000BHE6	XD16AWT-P0-0000-00000HHE6	
		R4	130	141	239	322			XD16AWT-P0-0000-00000HGE6	
		R3	122	132	225	302			XD16AWT-P0-0000-00000HFE6	
		R2	114	124	210	282				XD16AWT-P0-0000-00000UEE6
		Q5	107	116	197	265				XD16AWT-P0-0000-00000UDE6

Notes

- Cree LED maintains a tolerance of ±7% on flux and power measurements, ±0.005 on chromaticity (CCx, CCy) measurements and a tolerance of ±2 on CRI measurements. See the Measurements section (page 25).
- XLamp XD16 LED order codes specify only a minimum flux bin and not a maximum. Cree LED may ship reels in flux bins higher than the minimum specified by the order code without advance notice. Shipments will always adhere to the chromaticity bin restrictions specified by the order code.
- * Flux values @ 25 °C are calculated and for reference only.
- ** Flux values @ 700 mA and 1.0 A are calculated and for reference only.

FLUX CHARACTERISTICS (T_j = 85 °C) - CONTINUED

Chromaticity		Minimum Luminous Flux (lm) @ 350 mA			Calculated Minimum Luminous Flux (lm) @ 85 °C**		Order Codes			
Kit	CCT	Code	Flux (lm) @ 85 °C	Flux (lm) @ 25 °C*	700 mA	1.0 A	No Minimum CRI	70 CRI Minimum	80 CRI Minimum	90 CRI Minimum
F7	3200 K	S2	148	161	272	366	XD16AWT-P0-0000-000000JF7	XD16AWT-P0-0000-000000BJF7		
		R5	139	151	256	344	XD16AWT-P0-0000-000000HF7	XD16AWT-P0-0000-000000BHF7		
		R4	130	141	239	322	XD16AWT-P0-0000-000000GF7	XD16AWT-P0-0000-000000BGF7	XD16AWT-P0-0000-000000HGF7	
		R3	122	132	225	302			XD16AWT-P0-0000-000000HFF7	
		R2	114	124	210	282			XD16AWT-P0-0000-000000HEF7	XD16AWT-P0-0000-000000UEF7
		Q5	107	116	197	265				XD16AWT-P0-0000-000000UDF7
7E	3000 K	S2	148	161	272	366		XD16AWT-P0-0000-000000BJ7E		
		R5	139	151	256	344		XD16AWT-P0-0000-000000BH7E		
		R4	130	141	239	322		XD16AWT-P0-0000-000000BG7E	XD16AWT-P0-0000-000000HG7E	
		R3	122	132	225	302			XD16AWT-P0-0000-000000HF7E	
		R2	114	124	210	282			XD16AWT-P0-0000-000000HE7E	
		Q5	107	116	197	265				XD16AWT-P0-0000-000000UD7E
		Q4	100	109	184	247				XD16AWT-P0-0000-000000UC7E
7G	3000 K	R4	130	141	239	322			XD16AWT-P0-0000-000000HG7G	
		R3	122	132	225	302			XD16AWT-P0-0000-000000HF7G	
		R2	114	124	210	282			XD16AWT-P0-0000-000000HE7G	
		Q5	107	116	197	265				XD16AWT-P0-0000-000000UD7G
		Q4	100	109	184	247				XD16AWT-P0-0000-000000UC7G

Notes

- Cree LED maintains a tolerance of ±7% on flux and power measurements, ±0.005 on chromaticity (CCx, CCy) measurements and a tolerance of ±2 on CRI measurements. See the Measurements section (page 25).
- XLamp XD16 LED order codes specify only a minimum flux bin and not a maximum. Cree LED may ship reels in flux bins higher than the minimum specified by the order code without advance notice. Shipments will always adhere to the chromaticity bin restrictions specified by the order code.
- * Flux values @ 25 °C are calculated and for reference only.
- ** Flux values @ 700 mA and 1.0 A are calculated and for reference only.

FLUX CHARACTERISTICS (T_j = 85 °C) - CONTINUED

Chromaticity		Minimum Luminous Flux (lm) @ 350 mA			Calculated Minimum Luminous Flux (lm) @ 85 °C**		Order Codes			
Kit	CCT	Code	Flux (lm) @ 85 °C	Flux (lm) @ 25 °C*	700 mA	1.0 A	No Minimum CRI	70 CRI Minimum	80 CRI Minimum	90 CRI Minimum
E7	3000 K	S2	148	161	272	366	XD16AWT-P0-0000-000000JE7	XD16AWT-P0-0000-000000BJE7		
		R5	139	151	256	344	XD16AWT-P0-0000-000000HE7	XD16AWT-P0-0000-000000BHE7		
		R4	130	141	239	322	XD16AWT-P0-0000-000000GE7	XD16AWT-P0-0000-000000BGE7	XD16AWT-P0-0000-000000HGE7	
		R3	122	132	225	302			XD16AWT-P0-0000-000000HFE7	
		R2	114	124	210	282			XD16AWT-P0-0000-000000HEE7	
		Q5	107	116	197	265				XD16AWT-P0-0000-000000UDE7
		Q4	100	109	184	247				XD16AWT-P0-0000-000000UCE7
F8	2850 K	R4	130	141	239	322			XD16AWT-P0-0000-000000HGF8	
		R3	122	132	225	302			XD16AWT-P0-0000-000000HFF8	
		R2	114	124	210	282			XD16AWT-P0-0000-000000HEF8	
		Q5	107	116	197	265				XD16AWT-P0-0000-000000UDF8
		Q4	100	109	184	247				XD16AWT-P0-0000-000000UCF8
		Q3	93.9	102	173	232				XD16AWT-P0-0000-000000UBF8
8E	2700 K	R4	130	141	239	322			XD16AWT-P0-0000-000000HG8E	
		R3	122	132	225	302			XD16AWT-P0-0000-000000HF8E	
		R2	114	124	210	282			XD16AWT-P0-0000-000000HE8E	
		Q5	107	116	197	265				
		Q4	100	109	184	247				XD16AWT-P0-0000-000000UC8E
		Q3	93.9	102	173	232				XD16AWT-P0-0000-000000UB8E

Notes

- Cree LED maintains a tolerance of ±7% on flux and power measurements, ±0.005 on chromaticity (CCx, CCy) measurements and a tolerance of ±2 on CRI measurements. See the Measurements section (page 25).
- XLamp XD16 LED order codes specify only a minimum flux bin and not a maximum. Cree LED may ship reels in flux bins higher than the minimum specified by the order code without advance notice. Shipments will always adhere to the chromaticity bin restrictions specified by the order code.
- * Flux values @ 25 °C are calculated and for reference only.
- ** Flux values @ 700 mA and 1.0 A are calculated and for reference only.

FLUX CHARACTERISTICS (T_j = 85 °C) - CONTINUED

Chromaticity		Minimum Luminous Flux (lm) @ 350 mA			Calculated Minimum Luminous Flux (lm) @ 85 °C**		Order Codes			
Kit	CCT	Code	Flux (lm) @ 85 °C	Flux (lm) @ 25 °C*	700 mA	1.0 A	No Minimum CRI	70 CRI Minimum	80 CRI Minimum	90 CRI Minimum
8G	2700 K	R4	130	141	239	322			XD16AWT-P0-0000-00000HG8G	
		R3	122	132	225	302			XD16AWT-P0-0000-00000HF8G	
		R2	114	124	210	282			XD16AWT-P0-0000-00000HE8G	
		Q5	107	116	197	265				
		Q4	100	109	184	247				XD16AWT-P0-0000-00000UC8G
		Q3	93.9	102	173	232				XD16AWT-P0-0000-00000UB8G
E8	2700K	R4	130	141	239	322			XD16AWT-P0-0000-00000HGE8	
		R3	122	132	225	302			XD16AWT-P0-0000-00000HFE8	
		R2	114	124	210	282			XD16AWT-P0-0000-00000HEE8	
		Q5	107	116	197	265				
		Q4	100	109	184	247				XD16AWT-P0-0000-00000UCE8
		Q3	93.9	102	173	232				XD16AWT-P0-0000-00000UBE8
AG	2200 K	Q5	107	116	197	265			XD16AWT-P0-0000-00000HDAG	
		Q4	100	109	184	247			XD16AWT-P0-0000-00000HCAG	
		Q3	93.9	102	173	232				
		Q2	87.4	95	161	216				XD16AWT-P0-0000-00000UAAG
		P4	80.6	87	148	199				XD16AWT-P0-0000-00000U9AG
EA	2200 K	Q5	107	116	197	265			XD16AWT-P0-0000-00000HDEA	
		Q4	100	109	184	247			XD16AWT-P0-0000-00000HCEA	
		Q3	93.9	102	173	232				
		Q2	87.4	95	161	216				XD16AWT-P0-0000-00000UAEA
		P4	80.6	87	148	199				XD16AWT-P0-0000-00000U9EA

Notes

- Cree LED maintains a tolerance of ±7% on flux and power measurements, ±0.005 on chromaticity (CCx, CCy) measurements and a tolerance of ±2 on CRI measurements. See the Measurements section (page 25).
- XLamp XD16 LED order codes specify only a minimum flux bin and not a maximum. Cree LED may ship reels in flux bins higher than the minimum specified by the order code without advance notice. Shipments will always adhere to the chromaticity bin restrictions specified by the order code.
- * Flux values @ 25 °C are calculated and for reference only.
- ** Flux values @ 700 mA and 1.0 A are calculated and for reference only.

RELATIVE SPECTRAL POWER DISTRIBUTION

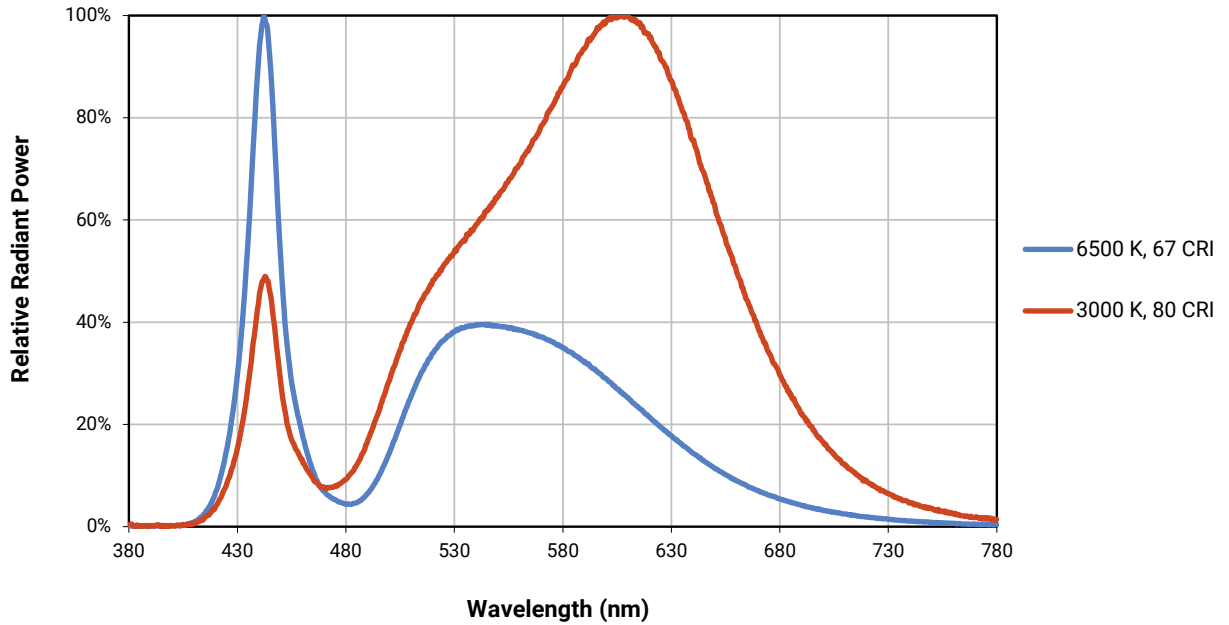

RELATIVE FLUX VS. JUNCTION TEMPERATURE ($I_F = 350 \text{ mA}$)

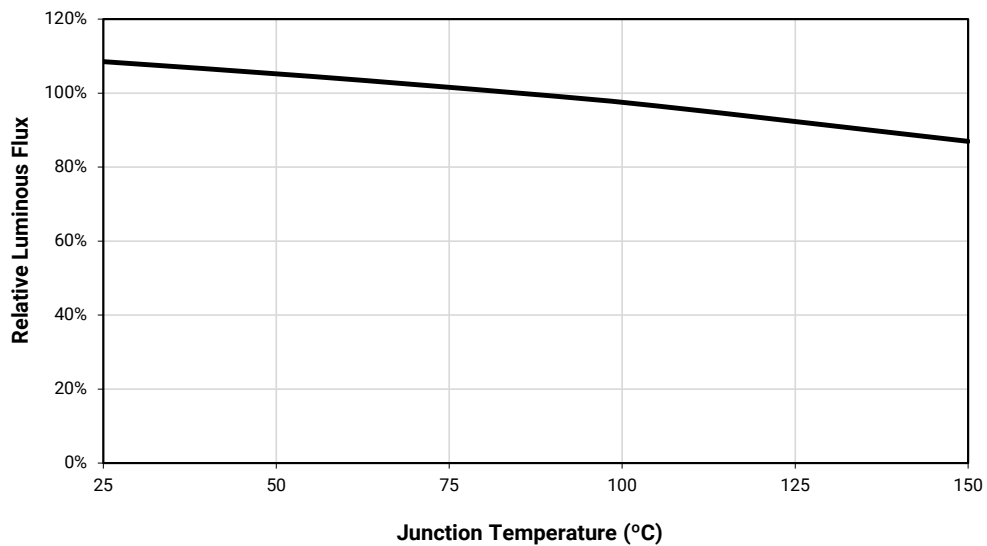

ELECTRICAL CHARACTERISTICS ($T_j = 85\text{ }^\circ\text{C}$)

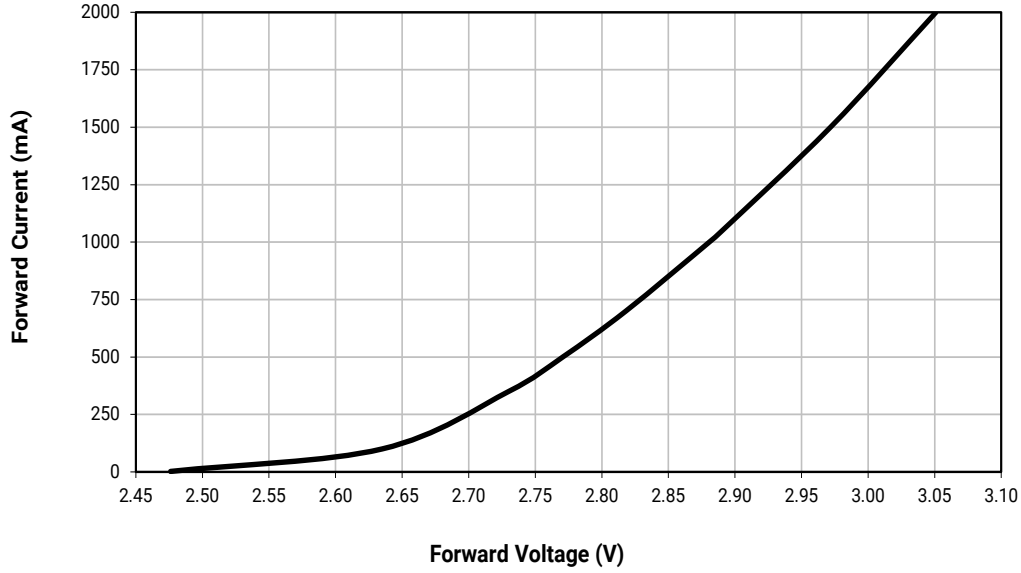

RELATIVE FLUX VS. CURRENT ($T_j = 85\text{ }^\circ\text{C}$)

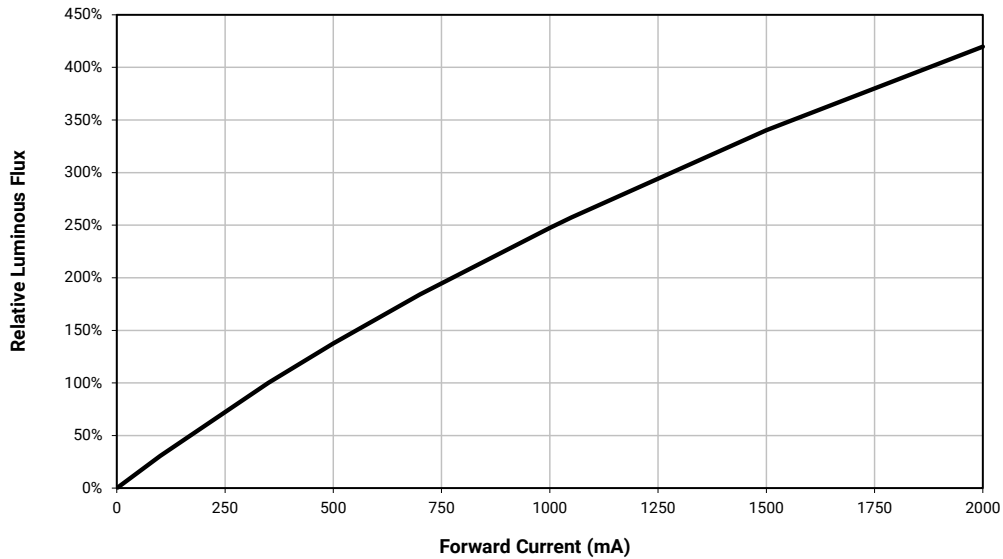

RELATIVE CHROMATICITY VS. CURRENT AND TEMPERATURE

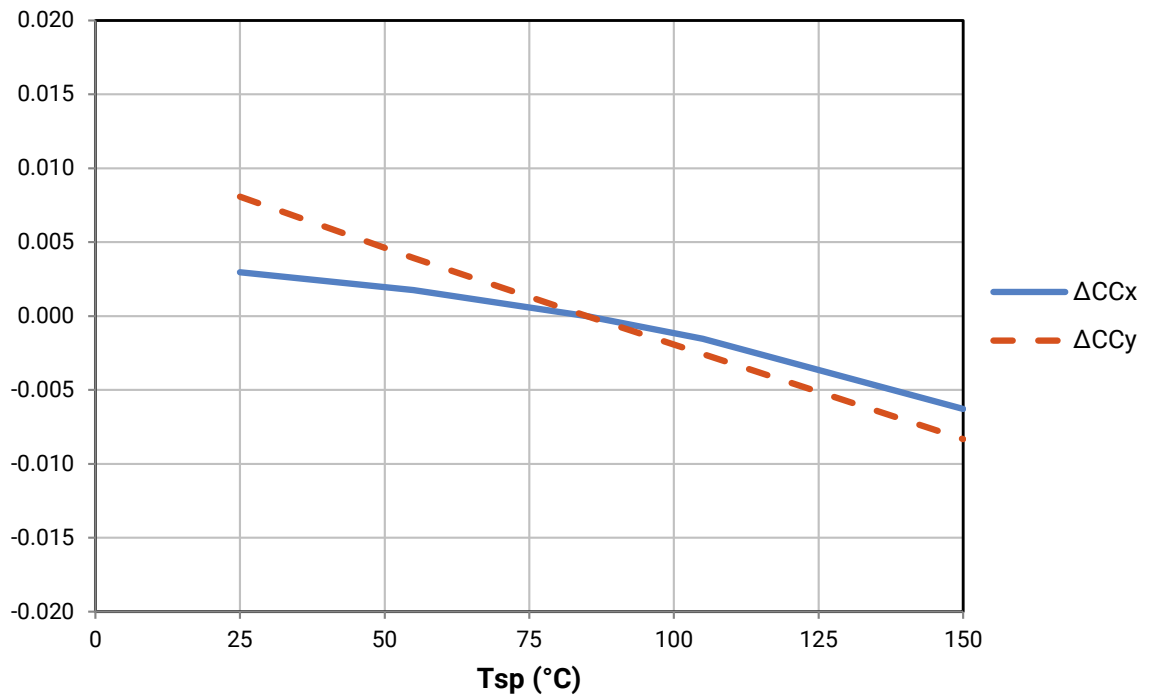
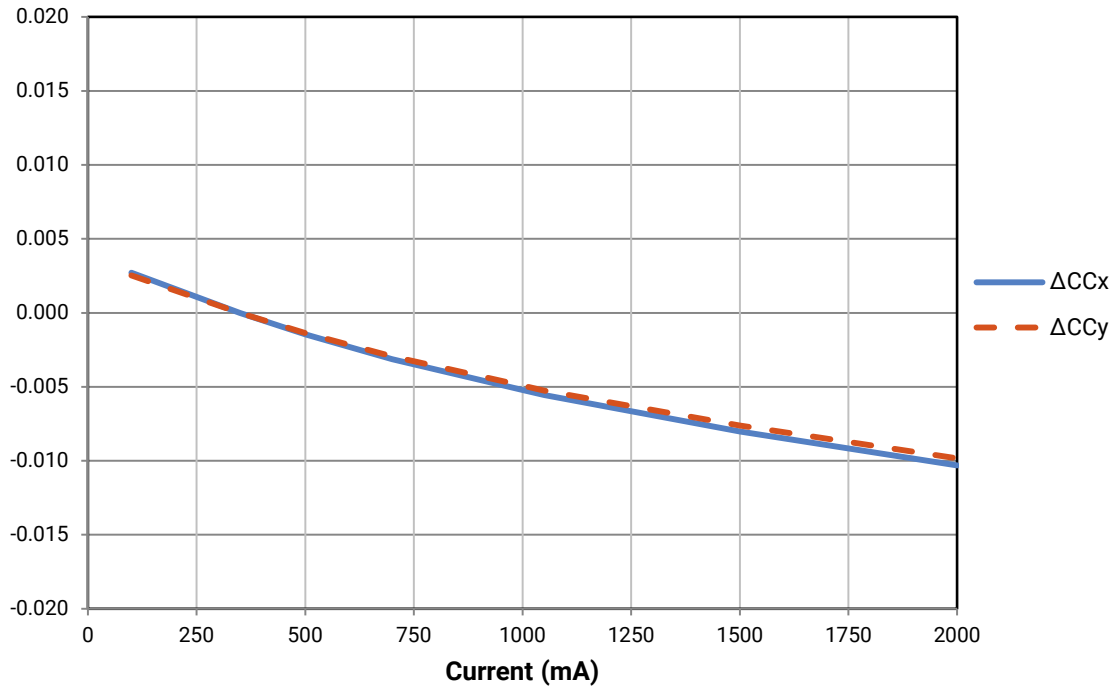

TYPICAL SPATIAL DISTRIBUTION

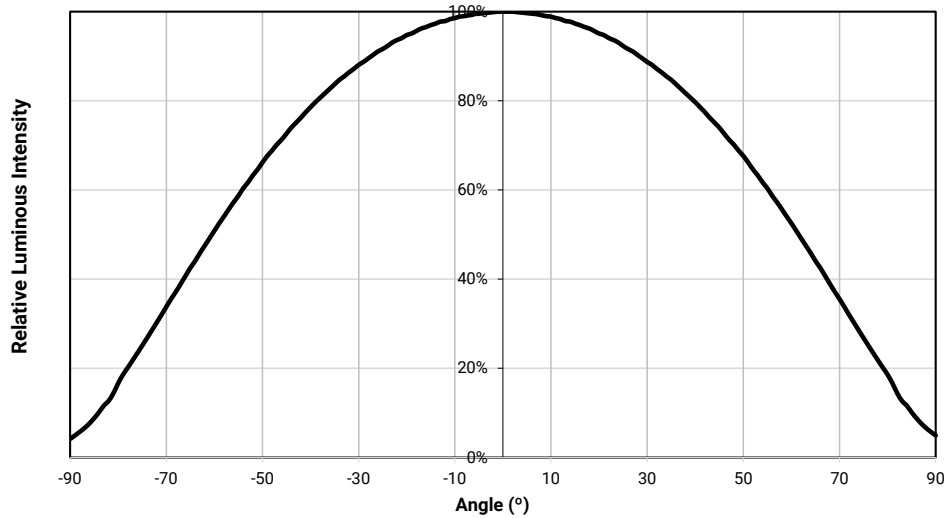

THERMAL DESIGN

The maximum forward current is determined by the thermal resistance between the LED junction and ambient. It is crucial for the end product to be designed in a manner that minimizes the thermal resistance from the solder point to ambient in order to optimize lamp life and optical characteristics.

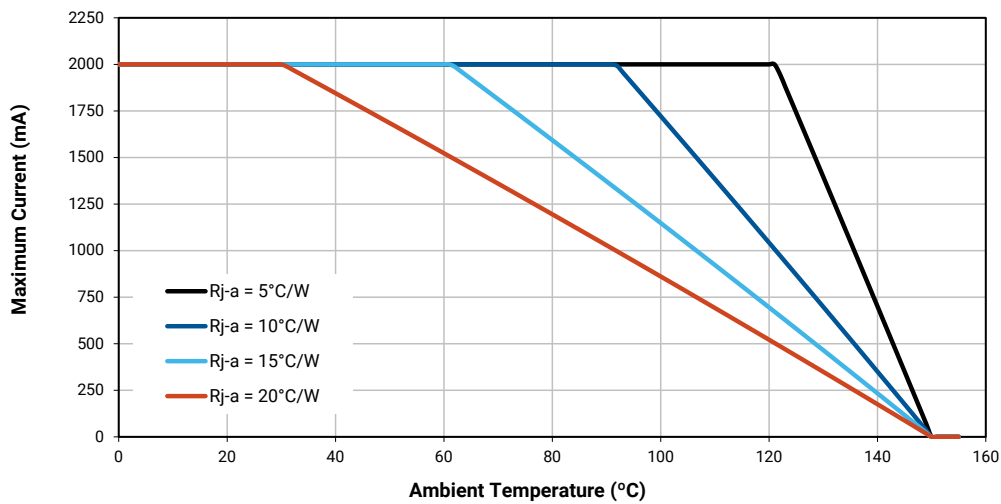

PERFORMANCE GROUPS - LUMINOUS FLUX (T_j = 85 °C)

XLamp XD16 Premium White LEDs are tested for luminous flux and placed into one of the following luminous-flux groups. The group codes, with a zero appended, are used in the bin code “Luminous flux group.” The flux groups are used in the order code “Minimum luminous flux group code.”

Group Code	Flux Group	Minimum Luminous Flux (lm) @ 350 mA	Maximum Luminous Flux (lm) @ 350 mA
P4	9	80.6	87.4
Q2	A	87.4	93.9
Q3	B	93.9	100
Q4	C	100	107
Q5	D	107	114
R2	E	114	122
R3	F	122	130
R4	G	130	139
R5	H	139	148
S2	J	148	156
S3	K	156	164
S4	L	164	172

PERFORMANCE GROUPS - CHROMATICITY

XLamp XD16 Premium White LEDs are tested for chromaticity and placed into one of the regions defined by the following bounding coordinates.

Region	x	y	Region	x	y	Region	x	y	Region	x	y
0A	0.2950	0.2970	0B	0.2920	0.3060	0C	0.2984	0.3133	0D	0.2984	0.3133
	0.2920	0.3060		0.2895	0.3135		0.2962	0.3220		0.3048	0.3207
	0.2984	0.3133		0.2962	0.3220		0.3028	0.3304		0.3068	0.3113
	0.3009	0.3042		0.2984	0.3133		0.3048	0.3207		0.3009	0.3042
0R	0.2980	0.2880	0S	0.2895	0.3135	0T	0.2962	0.3220	0U	0.3037	0.2937
	0.2950	0.2970		0.2870	0.3210		0.2937	0.3312		0.3009	0.3042
	0.3009	0.3042		0.2937	0.3312		0.3005	0.3415		0.3068	0.3113
	0.3037	0.2937		0.2962	0.3220		0.3028	0.3304		0.3093	0.2993
1A	0.3048	0.3207	1B	0.3028	0.3304	1C	0.3115	0.3391	1D	0.3130	0.3290
	0.3130	0.3290		0.3115	0.3391		0.3205	0.3481		0.3213	0.3373
	0.3144	0.3186		0.3130	0.3290		0.3213	0.3373		0.3221	0.3261
	0.3068	0.3113		0.3048	0.3207		0.3130	0.3290		0.3144	0.3186

PERFORMANCE GROUPS - CHROMATICITY (CONTINUED)

Region	x	y	Region	x	y	Region	x	y	Region	x	y
1R	0.3068	0.3113	1S	0.3005	0.3415	1T	0.3099	0.3509	1U	0.3144	0.3186
	0.3144	0.3186		0.3099	0.3509		0.3196	0.3602		0.3221	0.3261
	0.3161	0.3059		0.3115	0.3391		0.3205	0.3481		0.3231	0.3120
	0.3093	0.2993		0.3028	0.3304		0.3115	0.3391		0.3161	0.3059
2A	0.3215	0.3350	2B	0.3207	0.3462	2C	0.3290	0.3538	2D	0.3290	0.3417
	0.3290	0.3417		0.3290	0.3538		0.3376	0.3616		0.3371	0.3490
	0.3290	0.3300		0.3290	0.3417		0.3371	0.3490		0.3366	0.3369
	0.3222	0.3243		0.3215	0.3350		0.3290	0.3417		0.3290	0.3300
2R	0.3222	0.3243	2S	0.3196	0.3602	2T	0.3290	0.3690	2U	0.3290	0.3300
	0.3290	0.3300		0.3290	0.3690		0.3381	0.3762		0.3366	0.3369
	0.3290	0.3180		0.3290	0.3538		0.3376	0.3616		0.3361	0.3245
	0.3231	0.3120		0.3207	0.3462		0.3290	0.3538		0.3290	0.3180
3A	0.3371	0.3490	3B	0.3376	0.3616	3C	0.3463	0.3687	3D	0.3451	0.3554
	0.3451	0.3554		0.3463	0.3687		0.3551	0.3760		0.3533	0.3620
	0.3440	0.3427		0.3451	0.3554		0.3533	0.3620		0.3515	0.3487
	0.3366	0.3369		0.3371	0.3490		0.3451	0.3554		0.3440	0.3427
4A	0.3530	0.3597	4B	0.3548	0.3736	4C	0.3641	0.3804	4D	0.3615	0.3659
	0.3615	0.3659		0.3641	0.3804		0.3736	0.3874		0.3702	0.3722
	0.3590	0.3521		0.3615	0.3659		0.3702	0.3722		0.3670	0.3578
	0.3512	0.3465		0.3530	0.3597		0.3615	0.3659		0.3590	0.3521
5A	0.3670	0.3578	5B	0.3702	0.3722	5C	0.3825	0.3798	5D	0.3783	0.3646
	0.3702	0.3722		0.3736	0.3874		0.3869	0.3958		0.3825	0.3798
	0.3825	0.3798		0.3869	0.3958		0.4006	0.4044		0.3950	0.3875
	0.3783	0.3646		0.3825	0.3798		0.3950	0.3875		0.3898	0.3716
6A	0.3889	0.3690	6B	0.3941	0.3848	6C	0.4080	0.3916	6D	0.4017	0.3751
	0.3941	0.3848		0.3996	0.4015		0.4146	0.4089		0.4080	0.3916
	0.4080	0.3916		0.4146	0.4089		0.4299	0.4165		0.4221	0.3984
	0.4017	0.3751		0.4080	0.3916		0.4221	0.3984		0.4147	0.3814
7A	0.4221	0.3985	7B	0.4299	0.4165	7C	0.4430	0.4212	7D	0.4342	0.4028
	0.4342	0.4028		0.443	0.4212		0.4562	0.4260		0.4465	0.4071
	0.426	0.3853		0.4342	0.4028		0.4465	0.4071		0.4373	0.3893
	0.4147	0.3814		0.4221	0.3985		0.4342	0.4028		0.4260	0.3853
8A	0.4465	0.4071	8B	0.4562	0.4260	8C	0.4687	0.4289	8D	0.4582	0.4099
	0.4582	0.4099		0.4687	0.4289		0.4813	0.4319		0.4700	0.4126
	0.4483	0.3918		0.4582	0.4099		0.4700	0.4126		0.4593	0.3944
	0.4373	0.3893		0.4465	0.4071		0.4582	0.4099		0.4483	0.3918

PERFORMANCE GROUPS - CHROMATICITY (CONTINUED)

EasyWhite Color Temperatures – 3-Step Ellipse						
Bin Code	CCT	Center Point		Major Axis	Minor Axis	Rotation Angle (°)
		x	y	a	b	
5G	4000 K	0.3818	0.3797	0.0094	0.0040	53.72
6G	3500 K	0.4073	0.3917	0.0093	0.0041	53.22
7G	3000 K	0.4338	0.4030	0.0083	0.0041	53.20
8G	2700 K	0.4578	0.4101	0.0081	0.0042	53.70
AG	2200 K	0.5066	0.4158	0.0098	0.0048	45.50

EasyWhite Color Temperatures – 5-Step Ellipse						
Bin Code	CCT	Center Point		Major Axis	Minor Axis	Rotation Angle (°)
		x	y	a	b	
2E	5700 K	0.3287	0.3417	0.01230	0.00600	72.0
3E	5000 K	0.3447	0.3553	0.01400	0.00520	65.0
4E	4500 K	0.3611	0.3658	0.01420	0.00550	61.5
5E	4000 K	0.3818	0.3797	0.01565	0.00670	53.7
6E	3500 K	0.4073	0.3917	0.01545	0.00690	54.0
7E	3000 K	0.4338	0.4030	0.01390	0.00680	53.2
8E	2700 K	0.4577	0.4099	0.01350	0.00700	48.5

COOL WHITE KITS PLOTTED ON ANSI STANDARD CHROMATICITY REGIONS

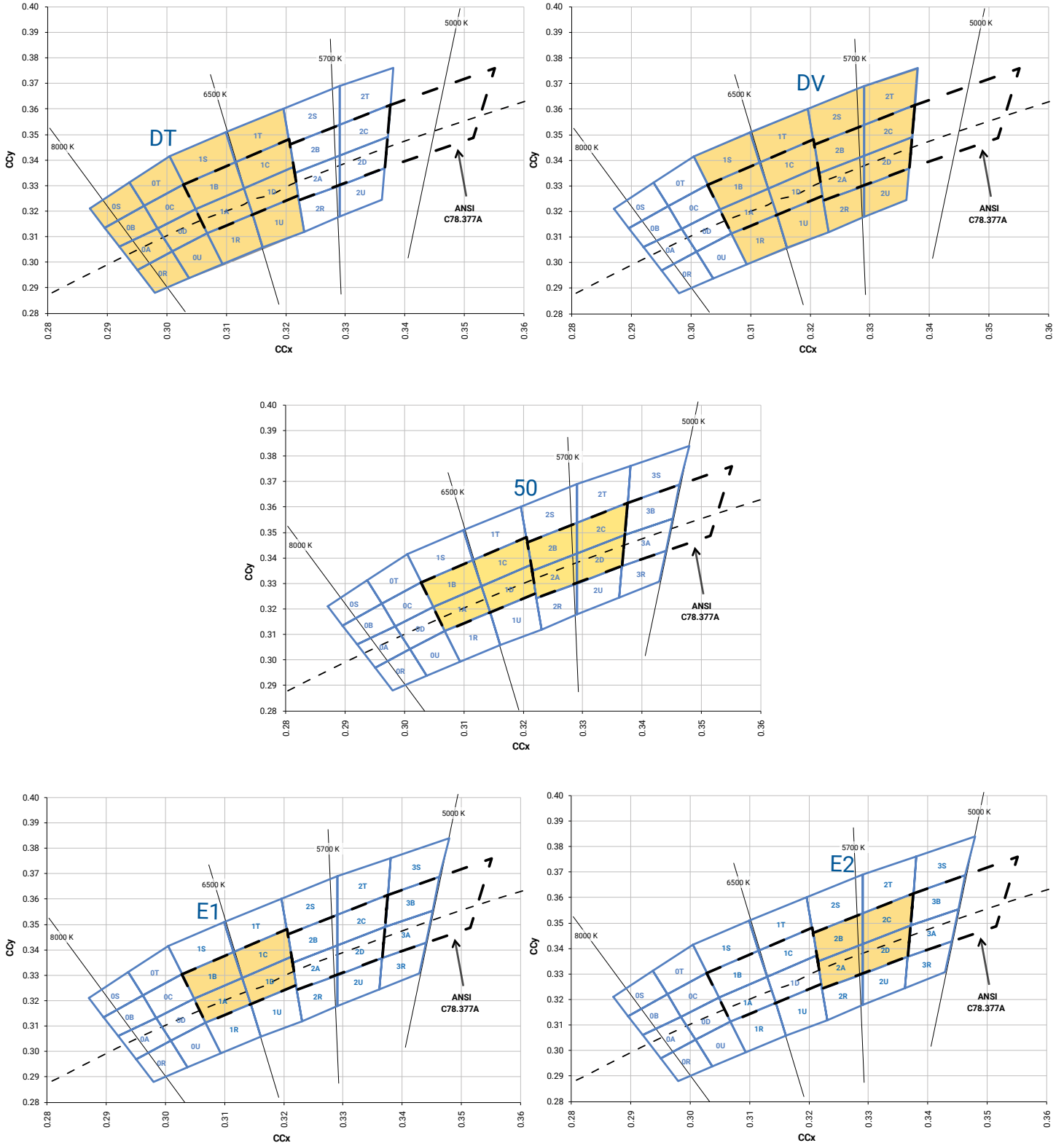

WARM AND NEUTRAL WHITE KITS PLOTTED ON ANSI STANDARD CHROMATICITY REGIONS

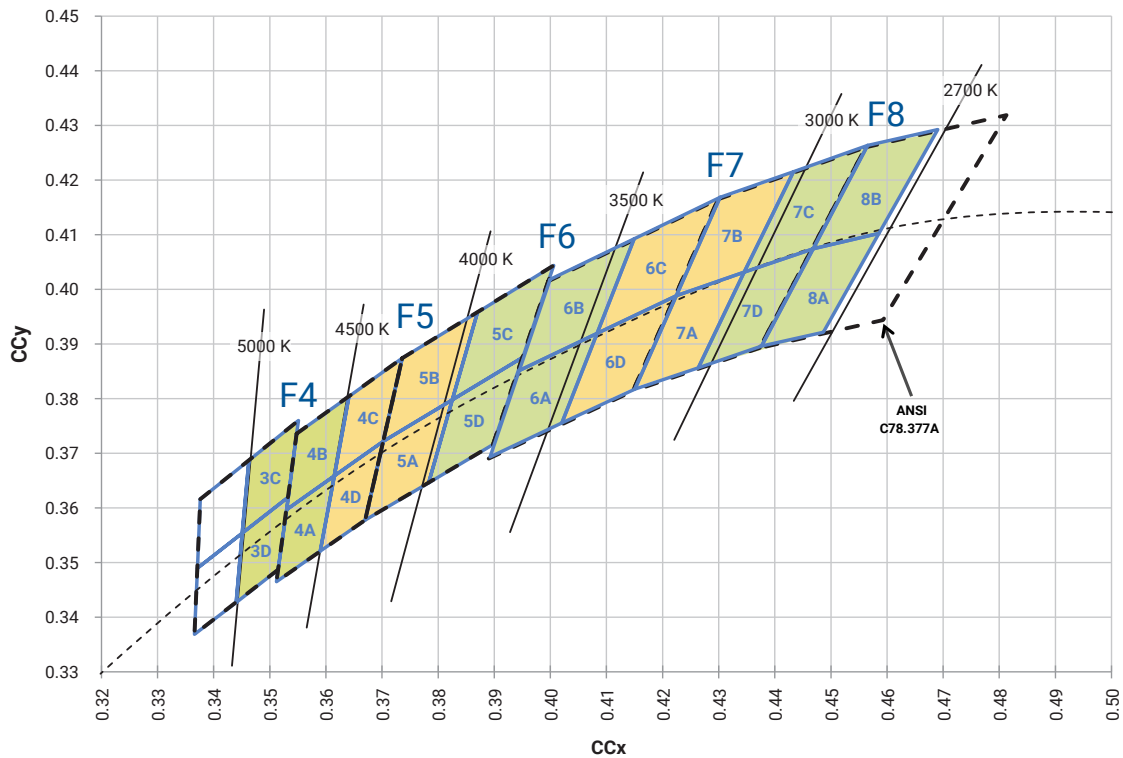
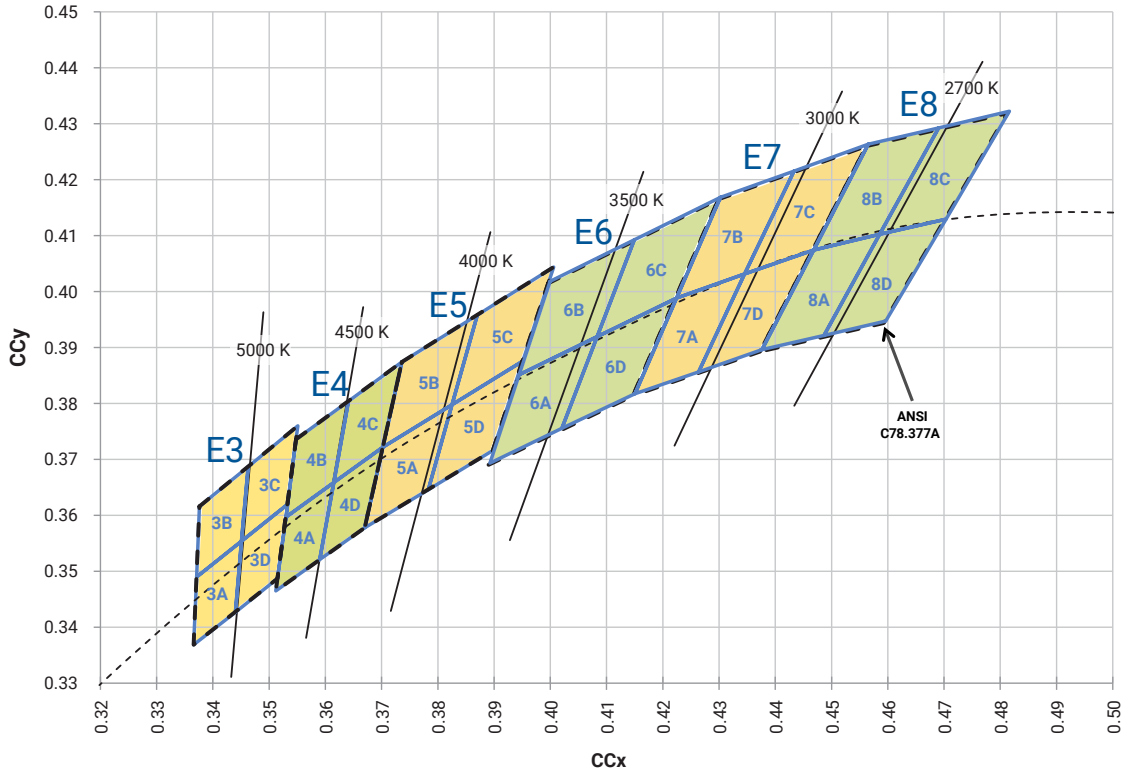

WARM WHITE KITS PLOTTED ON ANSI STANDARD CHROMATICITY REGIONS

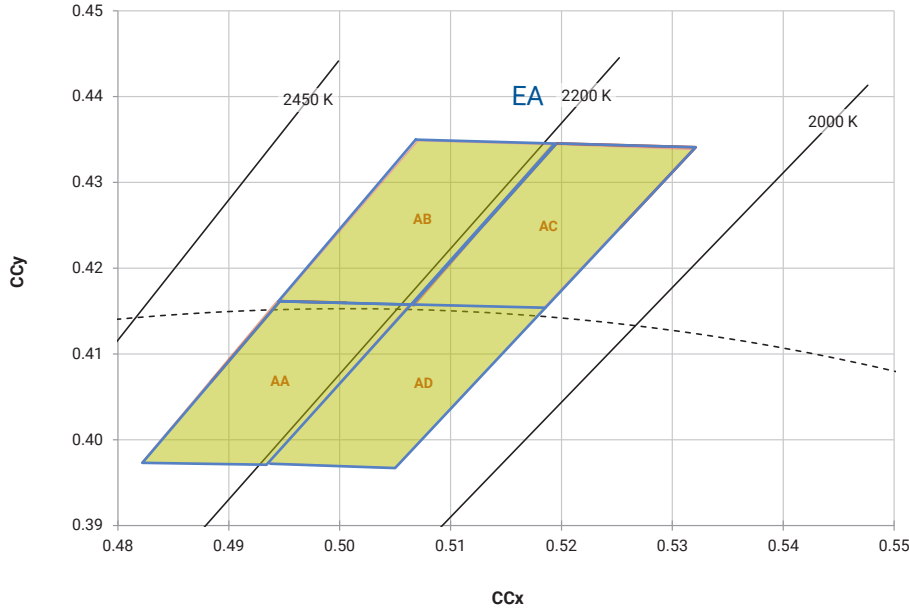

EASYWHITE® WHITE KITS PLOTTED ON ANSI STANDARD CHROMATICITY REGIONS

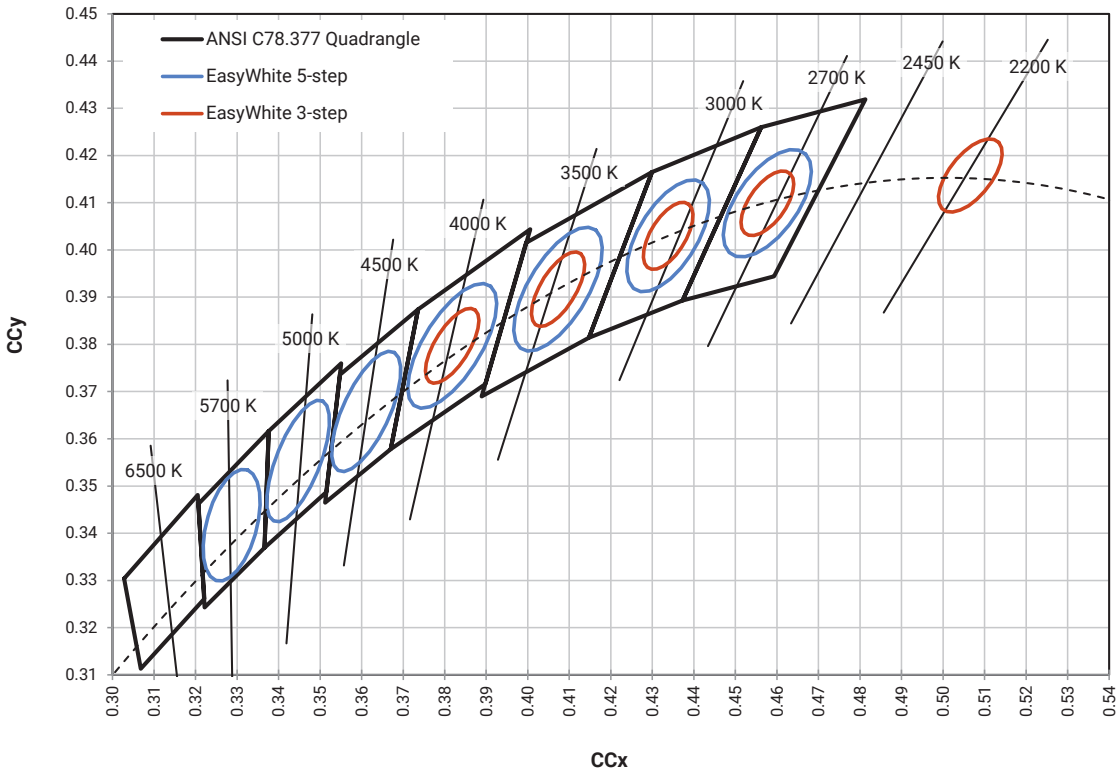

STANDARD CHROMATICITY KITS

The following table provides the chromaticity bins associated with chromaticity kits for XD16 Premium White LEDs.

Color	CCT	Kit	Chromaticity Bins
Cool White	7000 K	DT	0A, 0B, 0C, 0D, 0R, 0S, 0T, 0U, 1A, 1B, 1C, 1D, 1R, 1S, 1T, 1U
	6500 K	E1	1A, 1B, 1C, 1D
	6200 K	50	1A, 1B, 1C, 1D, 2A, 2B, 2C, 2D
	6000 K	DV	1A, 1B, 1C, 1D, 1R, 1S, 1T, 1U, 2A, 2B, 2C, 2D, 2R, 2S, 2T, 2U
	5700 K	E2	2A, 2B, 2C, 2D
	5700 K	2E	57E
Neutral White	5000 K	3E	50E
	5000 K	E3	3A, 3B, 3C, 3D
	4750 K	F4	3C, 3D, 4A, 4B
	4500 K	4E	45E
	4500 K	E4	4A, 4B, 4C, 4D
	4250 K	F5	4C, 4D, 5A, 5B
	4000 K	5E	40E, 40G
	4000 K	5G	40G
	4000 K	E5	5A, 5B, 5C, 5D
Warm White	3750 K	F6	5C, 5D, 6A, 6B
	3500 K	6E	35E, 35G
	3500 K	6G	35G
	3500 K	E6	6A, 6B, 6C, 6D
	3250 K	F7	6C, 6D, 7A, 7B
	3000 K	7E	30E, 30G
	3000 K	7G	30G
	3000 K	E7	7A, 7B, 7C, 7D
	2850 K	F8	7C, 7D, 8A, 8B
	2700 K	8E	27E, 27G
	2700 K	8G	27G
	2700 K	E8	8A, 8B, 8C, 8D
	2200 K	AG	22G
	2200 K	EA	AA, AB, AC, AD

BIN AND ORDER CODE FORMATS

Bin codes and order codes for XD16 Premium White LEDs are configured in the following manner:

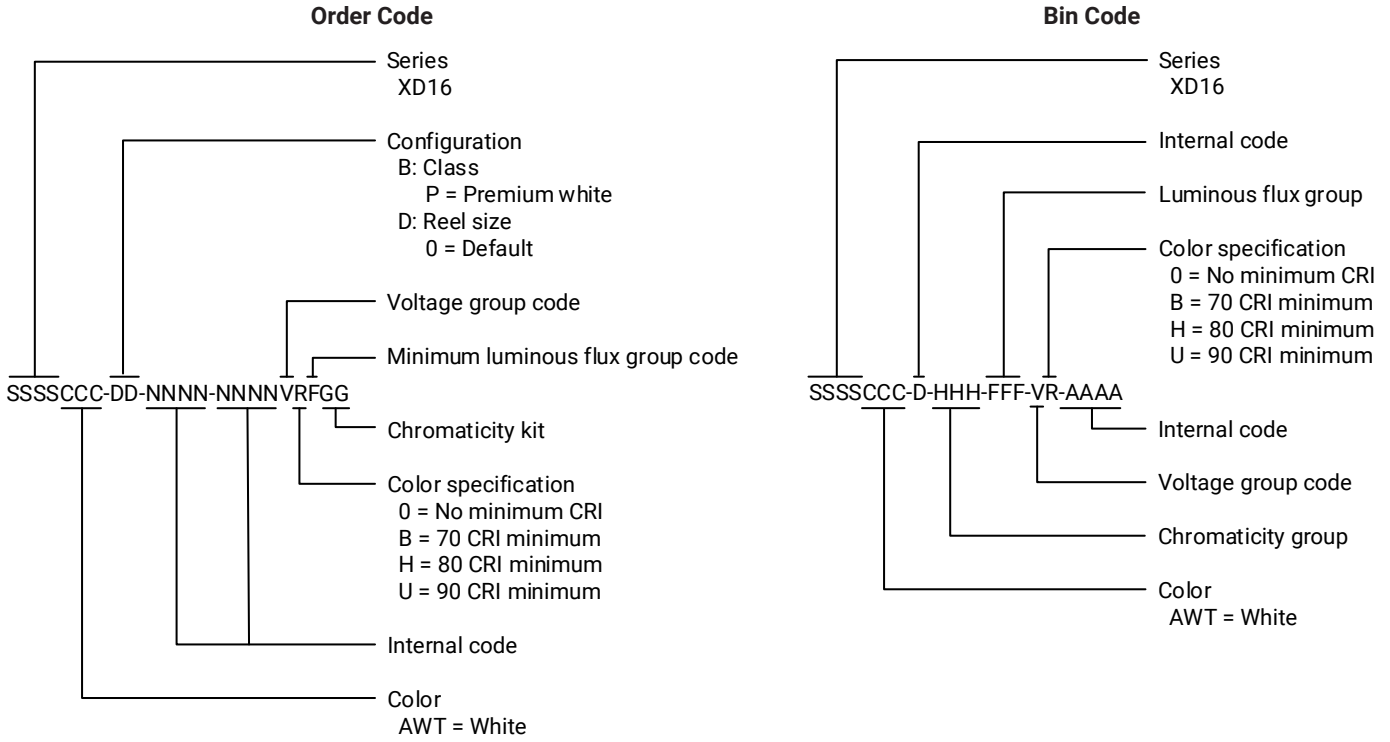

REFLOW SOLDERING CHARACTERISTICS

In testing, Cree LED has found XLamp XD16 Premium White LEDs to be compatible with JEDEC J-STD-020C, using the parameters listed below. As a general guideline, Cree LED recommends that users follow the recommended soldering profile provided by the manufacturer of the solder paste used, and therefore it is the lamp or luminaire manufacturer’s responsibility to determine applicable soldering requirements.

Note that this general guideline may not apply to all PCB designs and configurations of reflow soldering equipment.

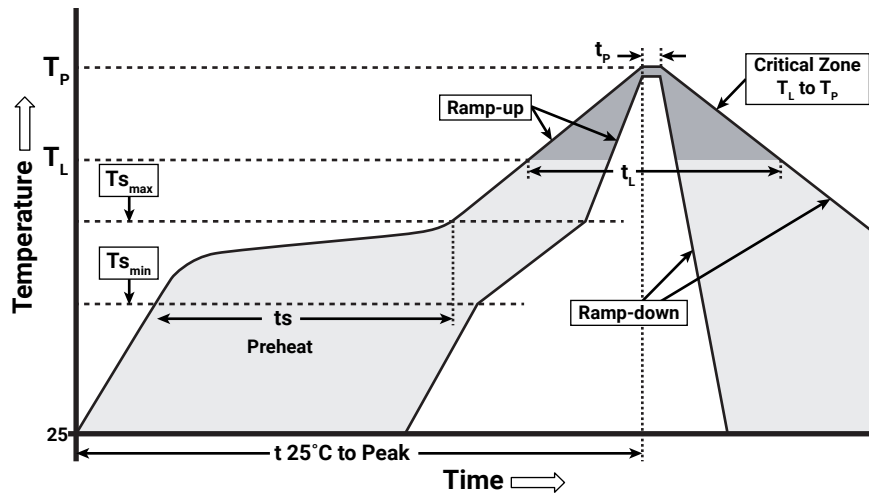

IPC/JEDEC J-STD-020C

Profile Feature	Lead-Free Solder
Average Ramp-Up Rate ($T_{s_{max}}$ to T_P)	1.2 °C/second
Preheat: Temperature Min ($T_{s_{min}}$)	120 °C
Preheat: Temperature Max ($T_{s_{max}}$)	170 °C
Preheat: Time ($T_{s_{min}}$ to $T_{s_{max}}$)	65-150 seconds
Time Maintained Above: Temperature (T_L)	217 °C
Time Maintained Above: Time (t_l)	45-90 seconds
Peak/Classification Temperature (T_P)	235 - 245 °C
Time Within 5 °C of Actual Peak Temperature (t_p)	20-40 seconds
Ramp-Down Rate	1 - 6 °C/second
Time 25 °C to Peak Temperature	4 minutes max.

Note: All temperatures refer to topside of the package, measured on the package body surface.

NOTES

Measurements

The luminous flux, radiant power, chromaticity, forward voltage and CRI measurements in this document are binning specifications only and solely represent product measurements as of the date of shipment. These measurements will change over time based on a number of factors that are not within Cree LED's control and are not intended or provided as operational specifications for the products. Calculated values are provided for informational purposes only and are not intended or provided as specifications.

Pre-Release Qualification Testing

Please read the [LED Reliability Overview](#) for details of the qualification process Cree LED applies to ensure long-term reliability for XLamp LEDs and details of Cree LED's pre-release qualification testing for XLamp LEDs. Cree LED did not perform Room Temperature Operating Life (RTOL) testing on the XD16 Premium White LED.

Lumen Maintenance

Cree LED now uses standardized IES LM-80-08 and TM-21-11 methods for collecting long-term data and extrapolating LED lumen maintenance. For information on the specific LM-80 data sets available for this LED, refer to the public [LM-80 results document](#).

Please read the [Long-Term Lumen Maintenance application note](#) for more details on Cree LED's lumen maintenance testing and forecasting. Please read the [Thermal Management application note](#) for details on how thermal design, ambient temperature, and drive current affect the LED junction temperature.

Moisture Sensitivity

Cree LED recommends keeping XLamp LEDs in the provided, resealable moisture-barrier packaging (MBP) until immediately prior to soldering. Unopened MBPs that contain XLamp LEDs do not need special storage for moisture sensitivity.

Once the MBP is opened, XLamp XD16 Premium White LEDs may be stored as MSL 1 per JEDEC J-STD-033, meaning they have unlimited floor life in conditions of ≤ 30 °C/85% relative humidity (RH). Regardless of storage condition, Cree LED recommends sealing any unsoldered LEDs in the original MBP.

UL® Recognized Component

This product meets the requirements to be considered a UL Recognized Component with Level 4 enclosure consideration. The LED package or a portion thereof has not been investigated as a fire enclosure or a fire and electrical enclosure per ANSI/UL 8750.

Vision Advisory

WARNING: Do not look at an exposed lamp in operation. Eye injury can result. For more information about LEDs and eye safety, please refer to the [LED Eye Safety application note](#).

MECHANICAL DIMENSIONS

Thermal vias, if present, are not shown on these drawings.

All dimensions in mm.

Measurement tolerances unless indicated otherwise: ± 0.13 mm

XD16 Premium White 7000 K–2700 K

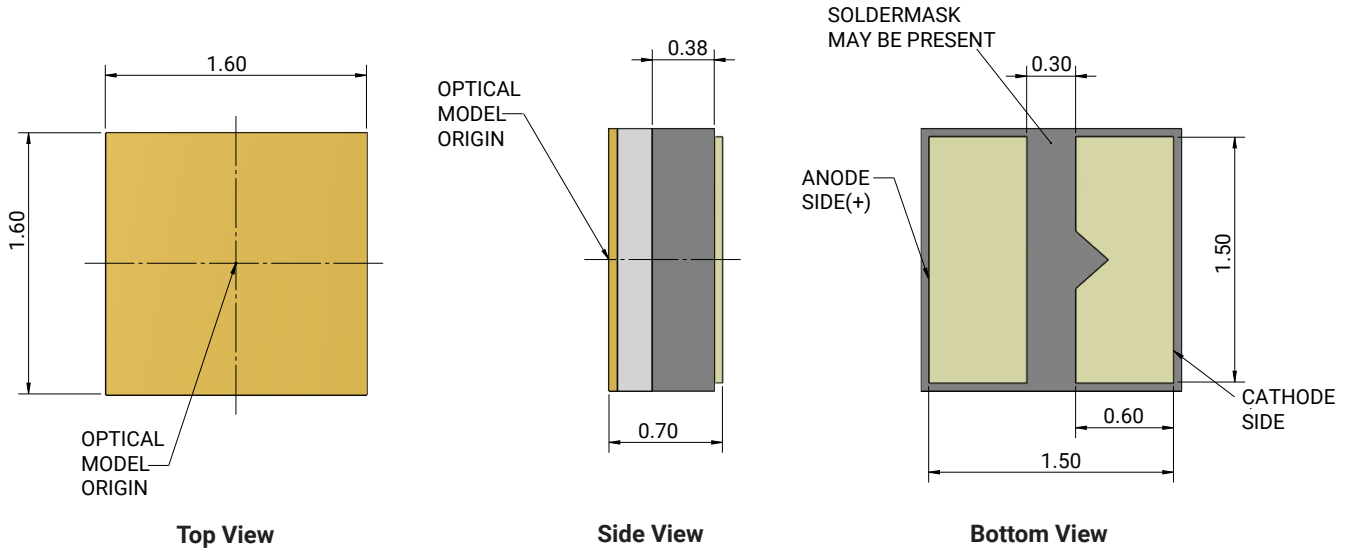

XD16 Premium White 2200 K

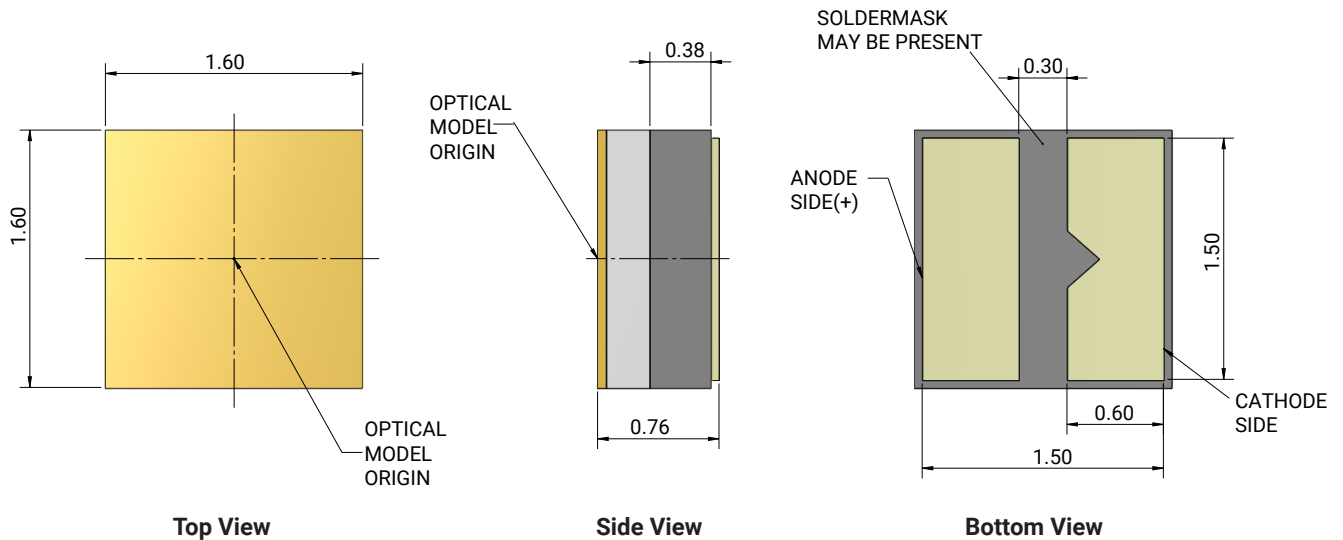

MECHANICAL DIMENSIONS - CONTINUED

XD16 Premium White 7000 K–2200 K

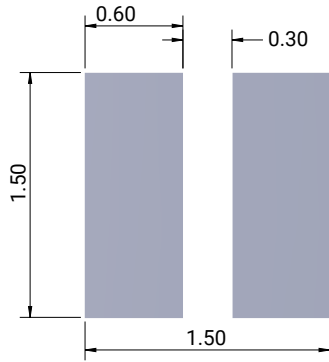

Recommended PC Footprint

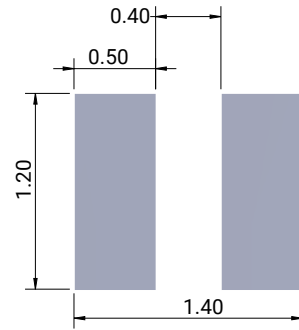

Recommended Stencil Opening

TAPE AND REEL

All Cree LED carrier tapes conform to EIA-481D, Automated Component Handling Systems Standard.

All dimensions in mm

All dimensions are ± 0.13 mm unless otherwise indicated.

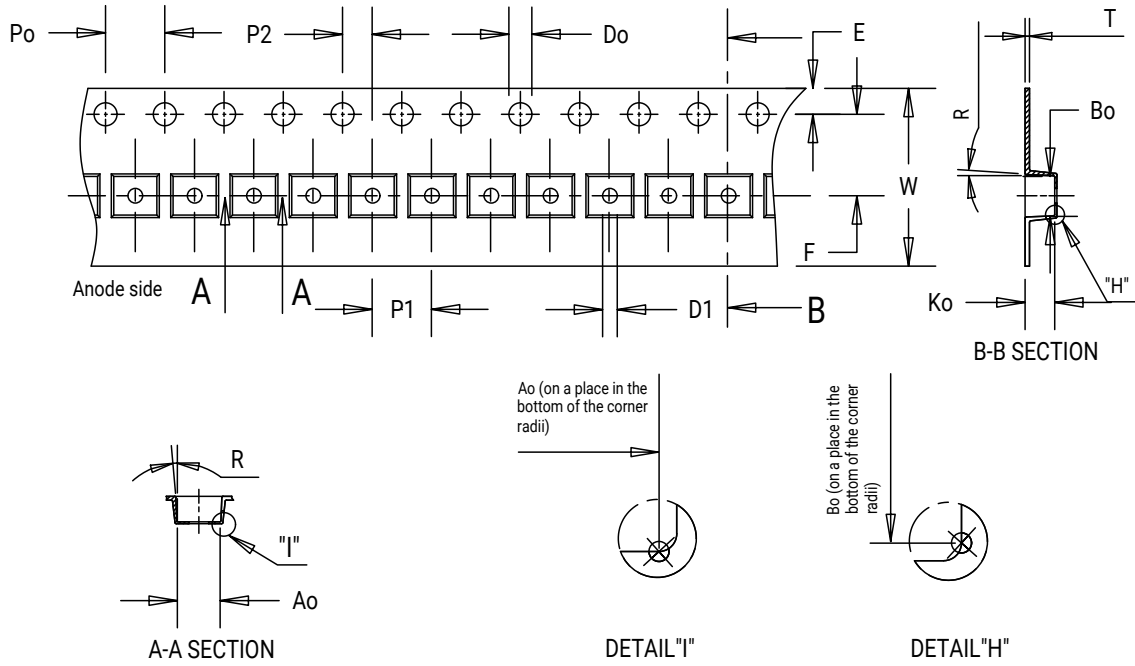

Item	Ao	Bo	Ko	Po	P1	P2	T	E	F	Do	D1	W	R
Dim.	1.85	1.85	1.00	4.00	4.00	2.00	0.30	1.75	3.50	1.50	1.00	12.00	5°

TAPE AND REEL - CONTINUED

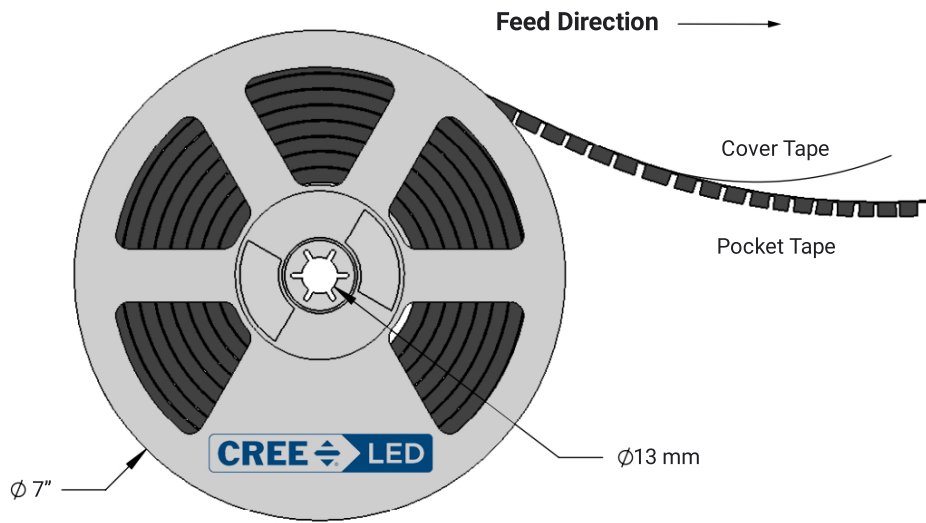
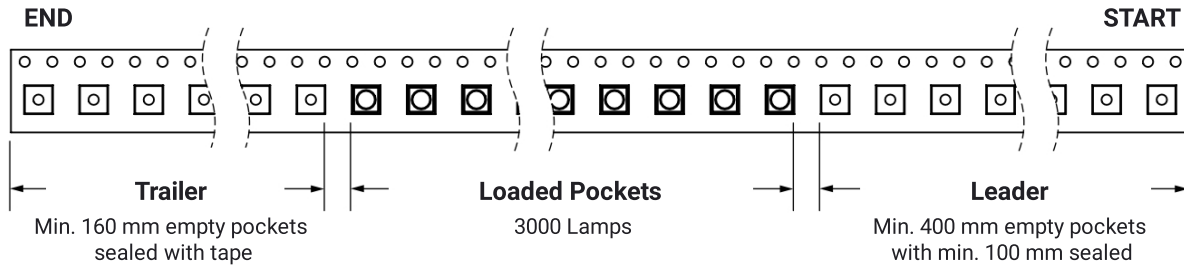

PACKAGING

The diagrams below show the packaging and labels Cree LED uses to ship XLamp XD16 Premium White LEDs. XLamp XD16 Premium White LEDs are shipped in tape loaded on a reel. Each box contains only one reel in a moisture barrier bag.

Unpackaged Reel

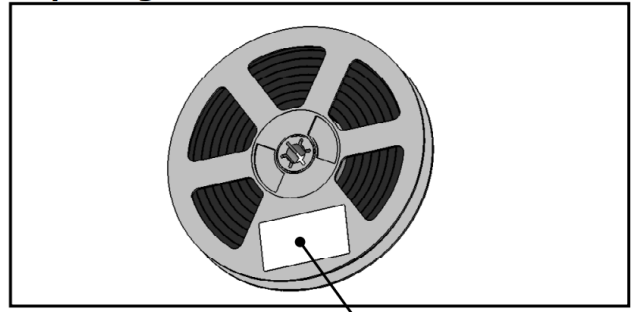

Label with Cree LED Bin Code, Quantity, Reel ID

Packaged Reel

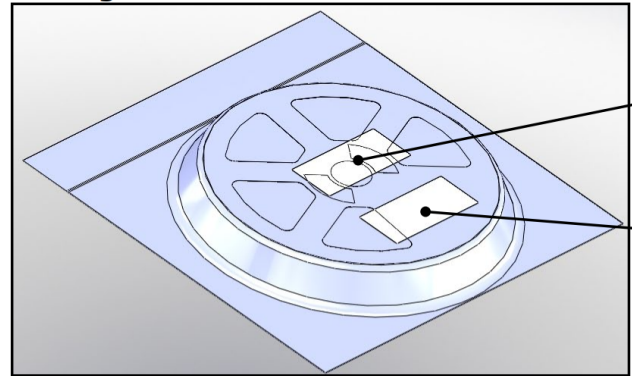

Label with Cree LED Order Code, Quantity, Reel ID, PO#

Label with Cree LED Bin Code, Quantity, Reel ID

Boxed Reel

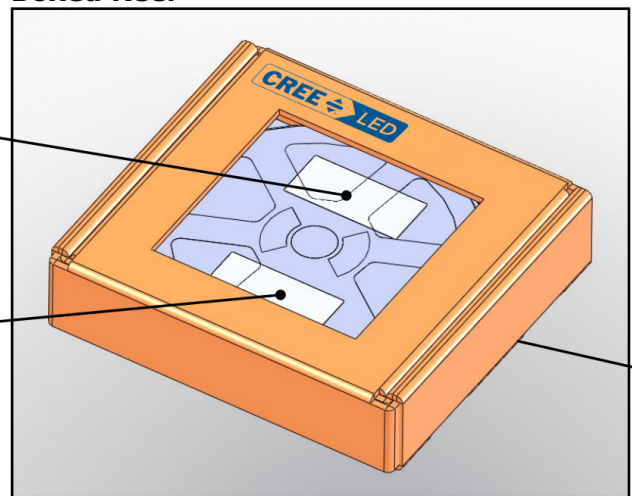

Label with Cree LED Order Code, Quantity, Reel ID, PO#

Label with Cree LED Bin Code, Quantity, Reel ID

Patent Label (on bottom of box)