

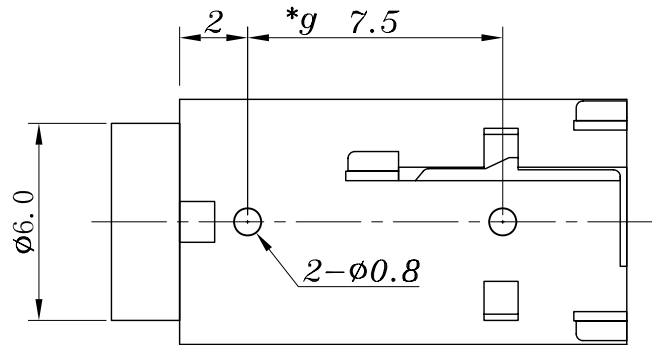

SCHMATIC

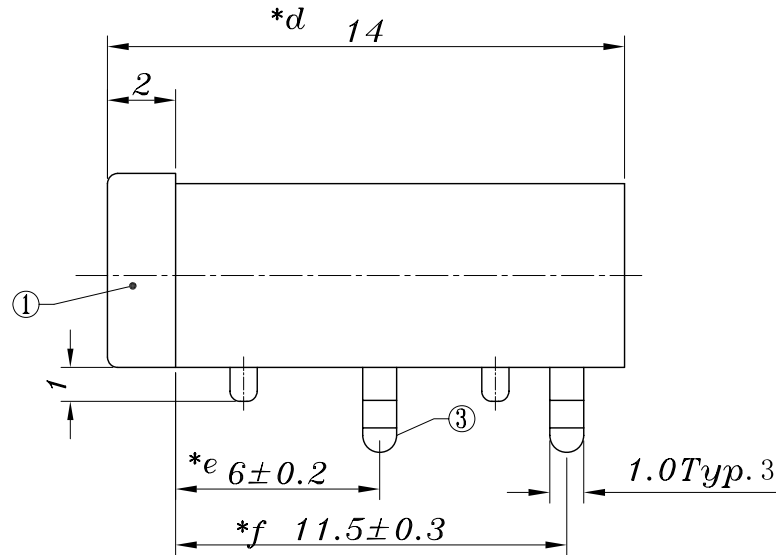

P.C.B LAYOUT
TOP VIEW

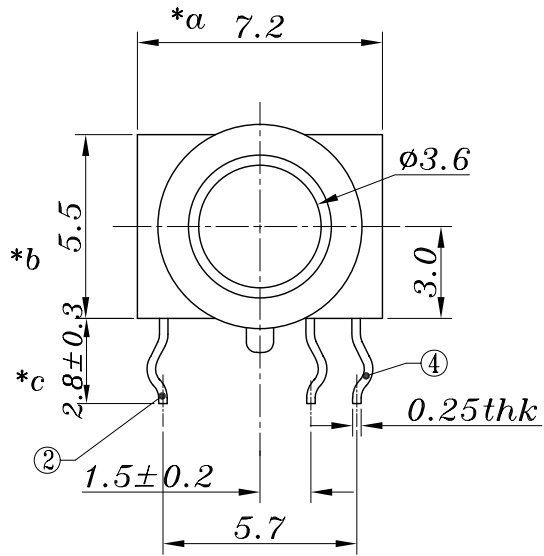
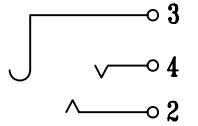
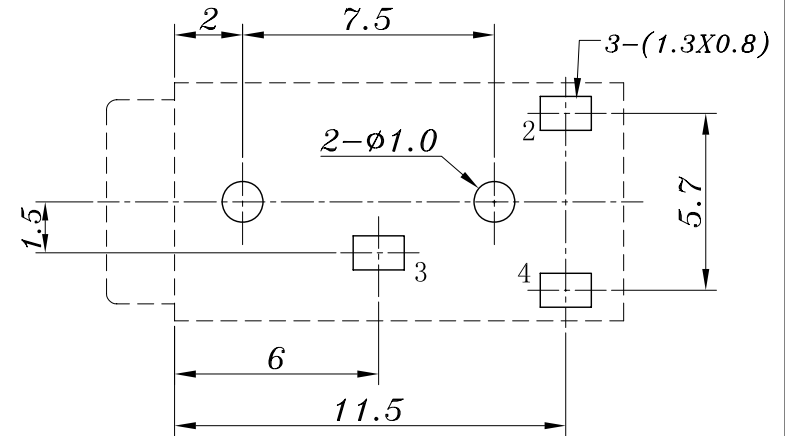

				TOLERANCE UNLESS SPECIFIED							
				UP TO 5mm: ±0.1	ANGULAR	1					
				ABOVE 5mm: ±0.2	±1°	NO	DATE	REVISIONS		BY	APPD
4	4#CONTACT FOOT	PBS	1	Ag-PLATED	TITLE: PHONE JACK			UNIT : MM	ROHS	DWN	
3	3#CONTACT FOOT	PBS	1	Ag-PLATED	MODEL: PJ-368-R			SCALE: 1:1	COMPLIANT	CHK'D	
2	2#CONTACT FOOT	PBS	1	Ag-PLATED	 HAOYU(HONGKONG)LIMITED 皓宇(香港)有限公司			APPD			
1	HOUSING	PBT	1	BLACK				PRO.AGL: 		REV :A0	
NO.	PART NAME	MATERIAL	QTY	FINISHING							