

General Description

The AOD403 uses advanced trench technology to provide excellent $R_{DS(ON)}$, low gate charge and low gate resistance. With the excellent thermal resistance of the TO-252 package, this device is well suited for high current load applications.

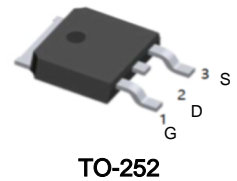

Features

V_{DS} (V) = -30V

$R_{DS(ON)} < 8m\Omega$ ($V_{GS} = -10V$)

$R_{DS(ON)} < 6.2m\Omega$ ($V_{GS} = -20V$)

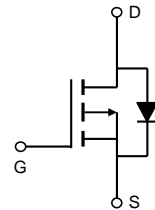

Absolute Maximum Ratings $T_A=25^\circ\text{C}$ unless otherwise noted

Parameter	Symbol	Maximum	Units
Drain-Source Voltage	V_{DS}	-30	V
Gate-Source Voltage	V_{GS}	± 25	V
Continuous Drain Current ^G	I_D	$T_C=25^\circ\text{C}$	-70
		$T_C=100^\circ\text{C}$	-55
Pulsed Drain Current ^C	I_{DM}	-200	A
Continuous Drain Current	I_{DSM}	$T_A=25^\circ\text{C}$	-15
		$T_A=70^\circ\text{C}$	-12
Avalanche Current ^C	I_{AS}, I_{AR}	-50	A
Avalanche energy $L=0.1mH$ ^C	E_{AS}, E_{AR}	125	mJ
Power Dissipation ^B	P_D	$T_C=25^\circ\text{C}$	90
		$T_C=100^\circ\text{C}$	45
Power Dissipation ^A	P_{DSM}	$T_A=25^\circ\text{C}$	2.5
		$T_A=70^\circ\text{C}$	1.6
Junction and Storage Temperature Range	T_J, T_{STG}	-55 to 175	$^\circ\text{C}$

Thermal Characteristics

Parameter	Symbol	Typ	Max	Units
Maximum Junction-to-Ambient ^A	$R_{\theta JA}$	16	20	$^\circ\text{C/W}$
Maximum Junction-to-Ambient ^{A D}		Steady-State	41	50
Maximum Junction-to-Case	$R_{\theta JC}$	0.9	1.6	$^\circ\text{C/W}$

Electrical Characteristics (T_J=25°C unless otherwise noted)

Symbol	Parameter	Conditions	Min	Typ	Max	Units
STATIC PARAMETERS						
BV _{DSS}	Drain-Source Breakdown Voltage	I _D =-250μA, V _{GS} =0V	-30			V
I _{DSS}	Zero Gate Voltage Drain Current	V _{DS} =-30V, V _{GS} =0V T _J =55°C			-1 -5	μA
I _{GSS}	Gate-Body leakage current	V _{DS} =0V, V _{GS} = ±25V			±100	nA
V _{GS(th)}	Gate Threshold Voltage	V _{DS} =V _{GS} , I _D =-250μA	-1.5	-2.5	-3.5	V
I _{D(ON)}	On state drain current	V _{GS} =-10V, V _{DS} =-5V	-200			A
R _{DS(ON)}	Static Drain-Source On-Resistance	V _{GS} =-20V, I _D =-20A TO252		5.1	6.2	mΩ
		V _{GS} =-10V, I _D =-20A TO252		6.2	8	mΩ
g _{FS}	Forward Transconductance	V _{DS} =-5V, I _D =-20A		42		S
V _{SD}	Diode Forward Voltage	I _S =-1A, V _{GS} =0V		-0.7	-1	V
I _S	Maximum Body-Diode Continuous Current				-70	A
DYNAMIC PARAMETERS						
C _{iss}	Input Capacitance	V _{GS} =0V, V _{DS} =-15V, f=1MHz	2310	2890	3500	pF
C _{oss}	Output Capacitance		410	585	760	pF
C _{riss}	Reverse Transfer Capacitance		280	470	660	pF
R _g	Gate resistance	V _{GS} =0V, V _{DS} =0V, f=1MHz	1.9	3.8	5.7	Ω
SWITCHING PARAMETERS						
Q _{gs}	Gate Source Charge	V _{GS} =-10V, V _{DS} =-15V, I _D =-20A	10	12	14	nC
Q _{gd}	Gate Drain Charge		10	16	22	nC
t _{D(on)}	Turn-On DelayTime	V _{GS} =-10V, V _{DS} =-15V, R _L =0.75Ω, R _{GEN} =3Ω		16		ns
t _r	Turn-On Rise Time			12		ns
t _{D(off)}	Turn-Off DelayTime			45		ns
t _f	Turn-Off Fall Time			22		ns
t _{rr}	Body Diode Reverse Recovery Time	I _F =-20A, dI/dt=100A/μs	14	18	22	ns
Q _{rr}	Body Diode Reverse Recovery Charge	I _F =-20A, dI/dt=100A/μs	9	11	13	nC

- A. The value of R_{θJA} is measured with the device mounted on 1in² FR-4 board with 2oz. Copper, in a still air environment with T_A=25° C. The Power dissipation P_{DSM} is based on R_{θJA} and the maximum allowed junction temperature of 150° C. The value in any given application depends on the user's specific board design, and the maximum temperature of 175° C may be used if the PCB allows it.
- B. The power dissipation P_D is based on T_{J(MAX)}=175° C, using junction-to-case thermal resistance, and is more useful in setting the upper dissipation limit for cases where additional heatsinking is used.
- C. Repetitive rating, pulse width limited by junction temperature T_{J(MAX)}=175° C. Ratings are based on low frequency and duty cycles to keep initial T_J=25° C.
- D. The R_{θJA} is the sum of the thermal impedance from junction to case R_{θJC} and case to ambient.
- E. The static characteristics in Figures 1 to 6 are obtained using <300μs pulses, duty cycle 0.5% max.
- F. These curves are based on the junction-to-case thermal impedance which is measured with the device mounted to a large heatsink, assuming a maximum junction temperature of T_{J(MAX)}=175° C. The SOA curve provides a single pulse rating.
- G. The maximum current rating is package limited.
- H. These tests are performed with the device mounted on 1 in² FR-4 board with 2oz. Copper, in a still air environment with T_A=25° C.

Typical Characteristics

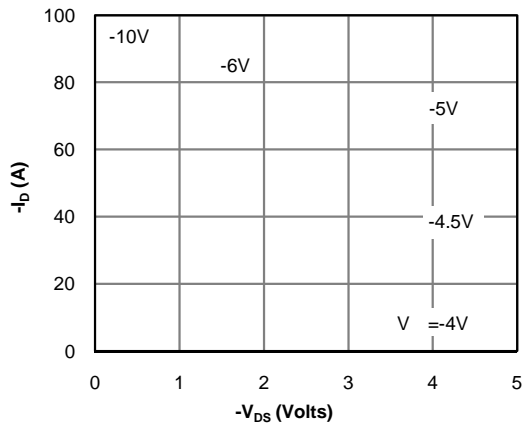

Figure 1: On-Region Characteristics (Note E)

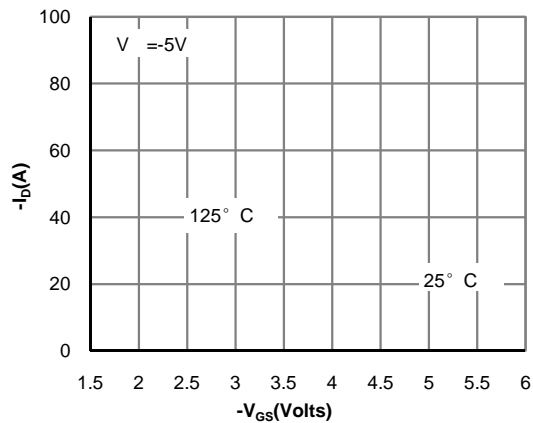

Figure 2: Transfer Characteristics (Note E)

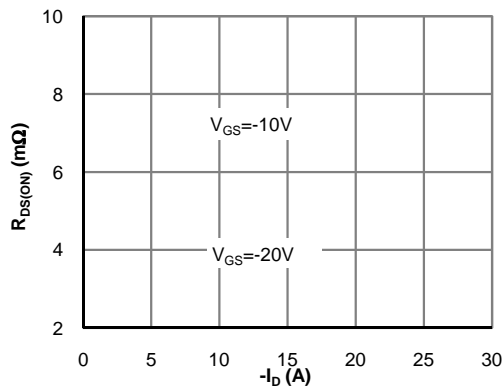

Figure 3: On-Resistance vs. Drain Current and

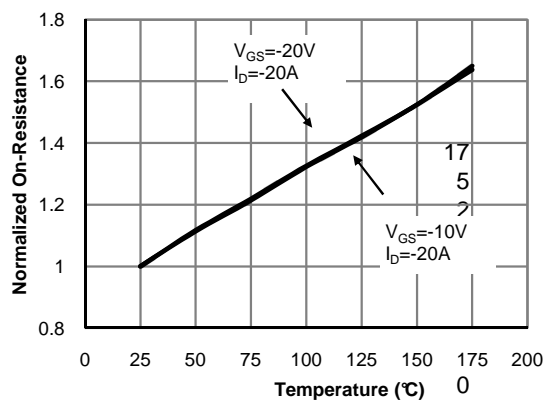

Figure 4: On-Resistance vs. Junction Temperature

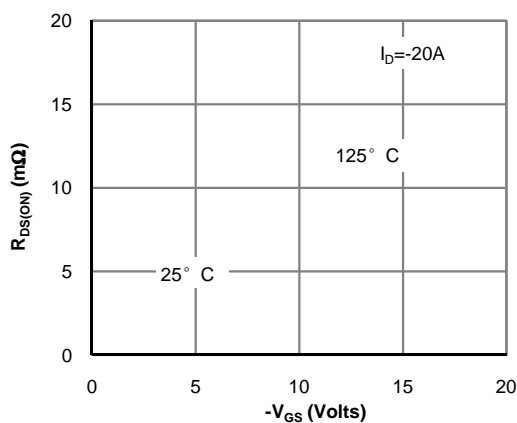

Figure 5: On-Resistance vs. Gate-Source Voltage (Note E)

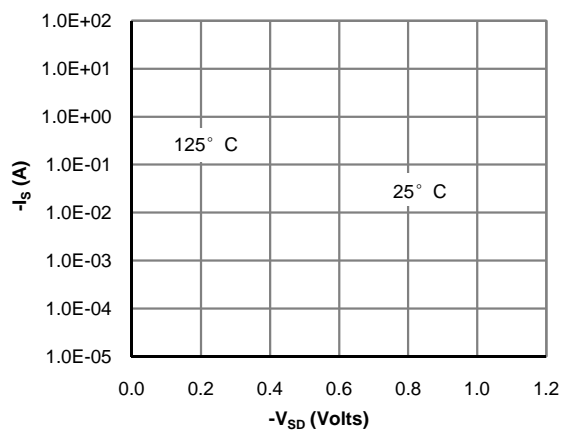

Figure 6: Body-Diode Characteristics (Note E)

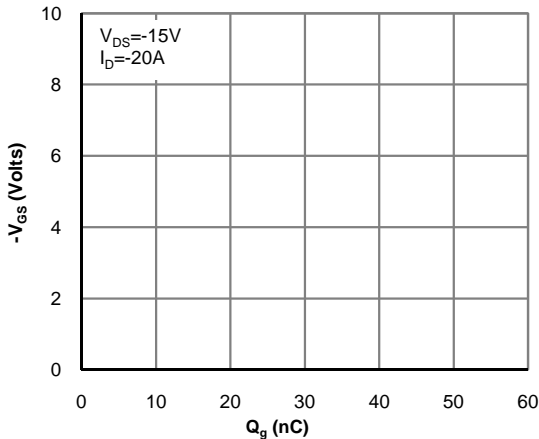

Figure 7: Gate-Charge Characteristics

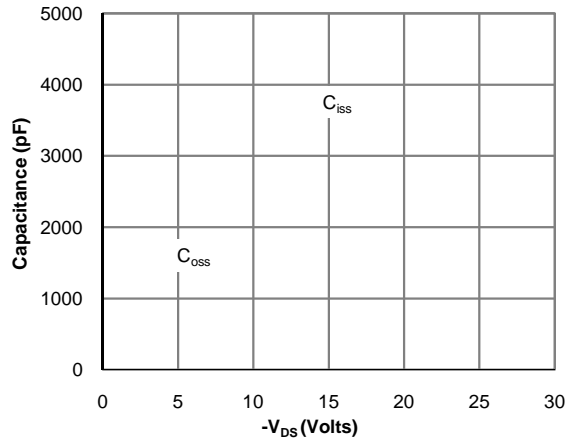
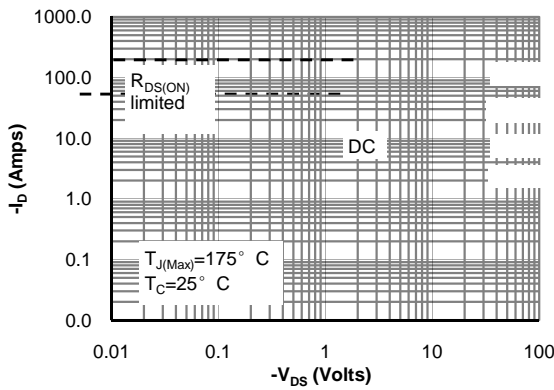
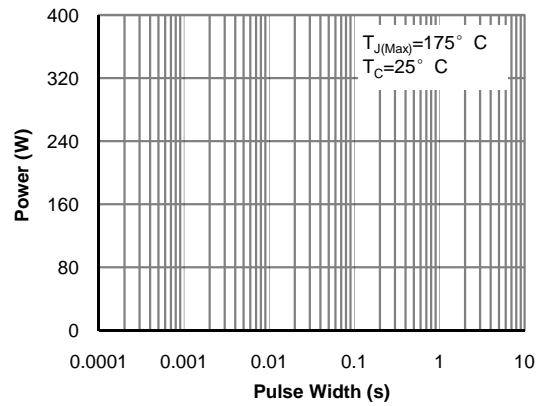

Figure 8: Capacitance Characteristics



Safe Operating Area (Note F)



Case (Note F)

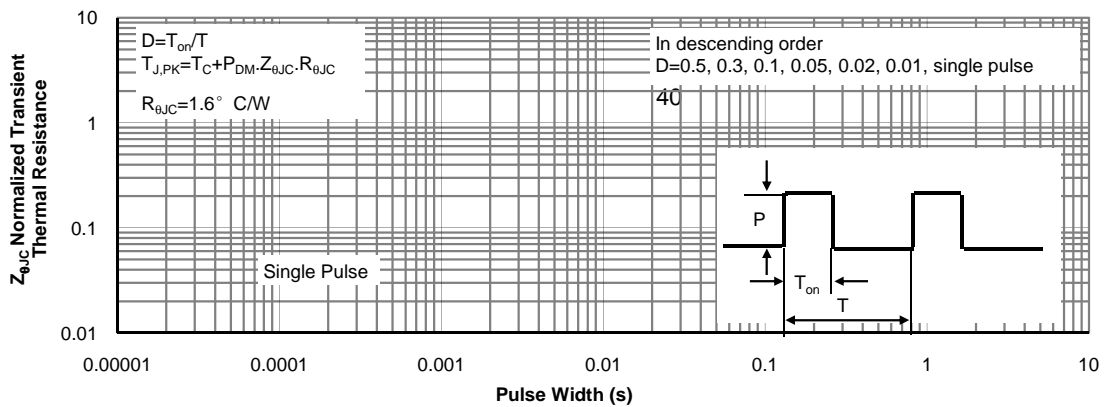
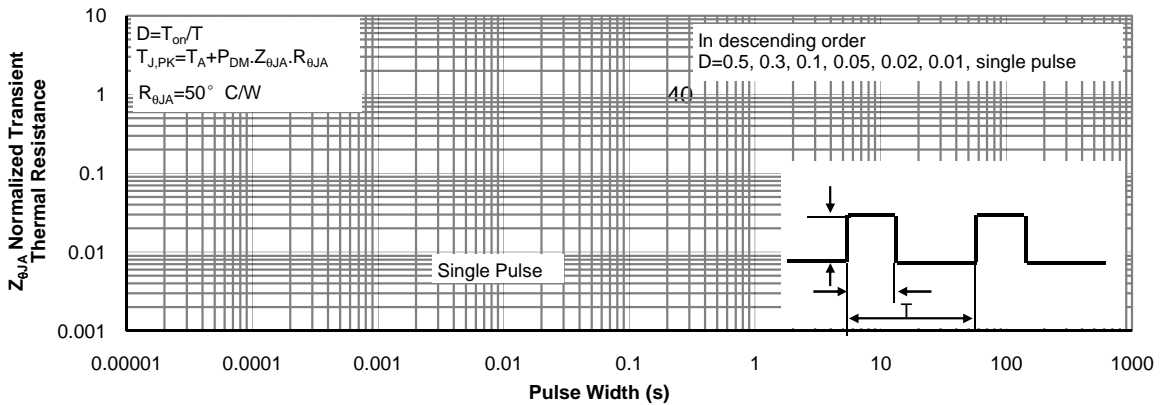
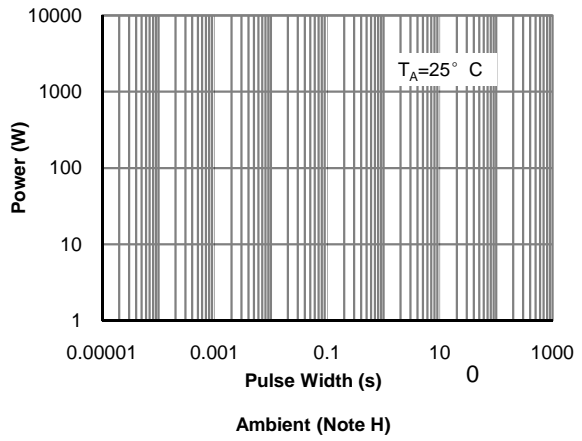
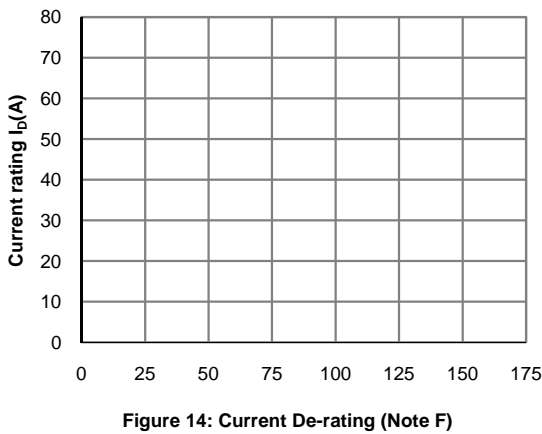
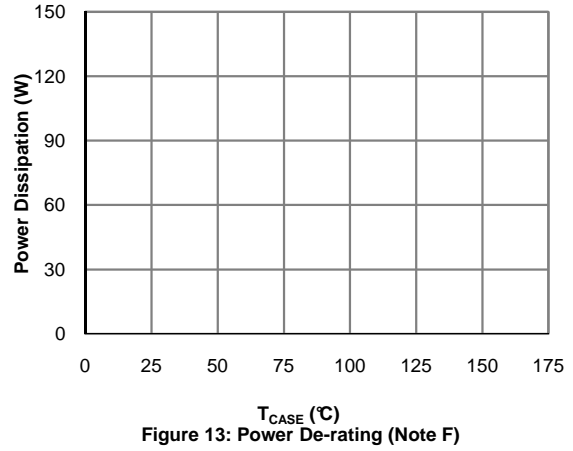
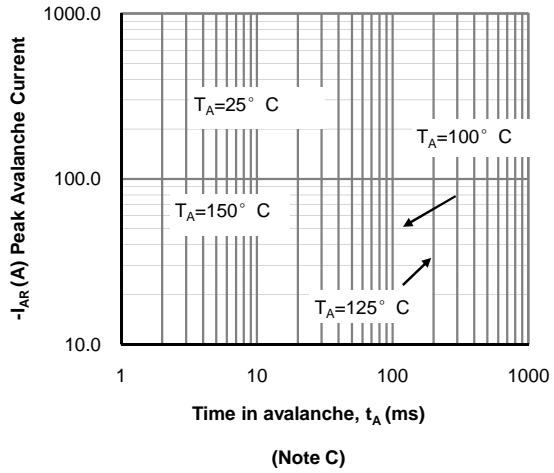
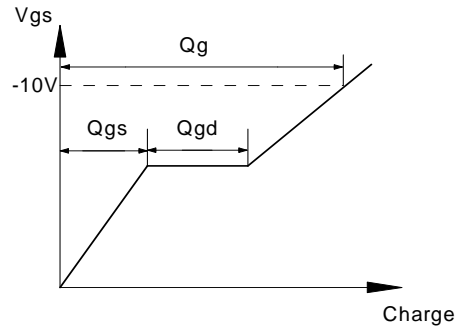
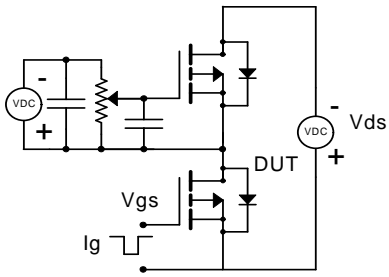

Figure 11: Normalized Maximum Transient Thermal Impedance (Note F)



Gate Charge Test Circuit & Waveform



Resistive Switching Test Circuit & Waveforms

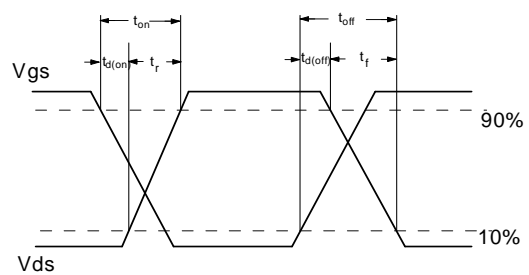
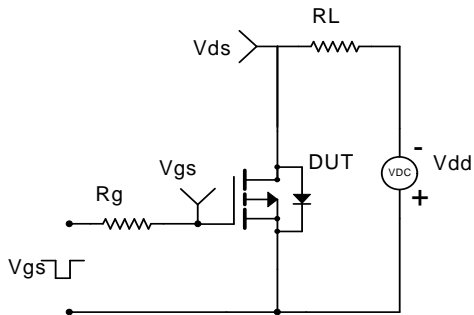

Unclamped Inductive Switching (UIS) Test Circuit & Waveforms

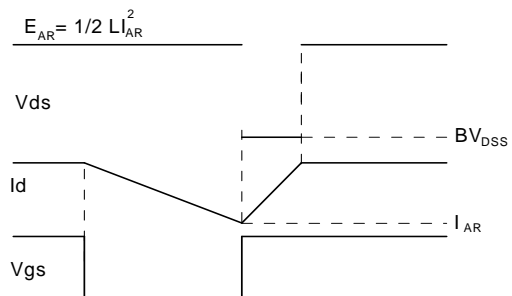
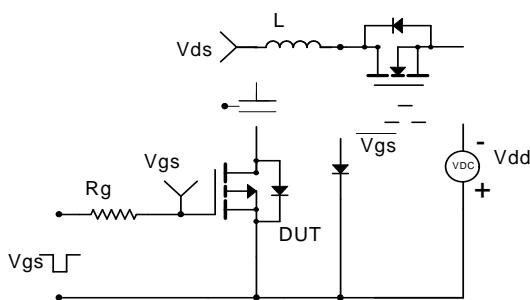

Diode Recovery Test Circuit & Waveforms

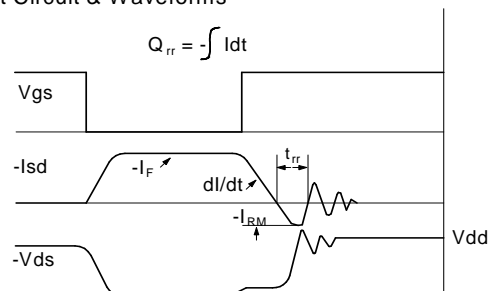
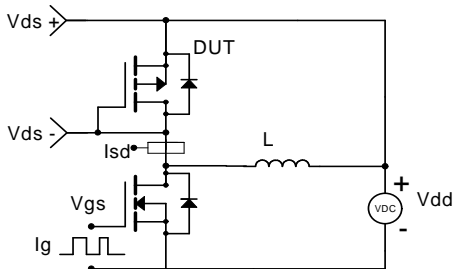

Package Mechanical Data TO-252

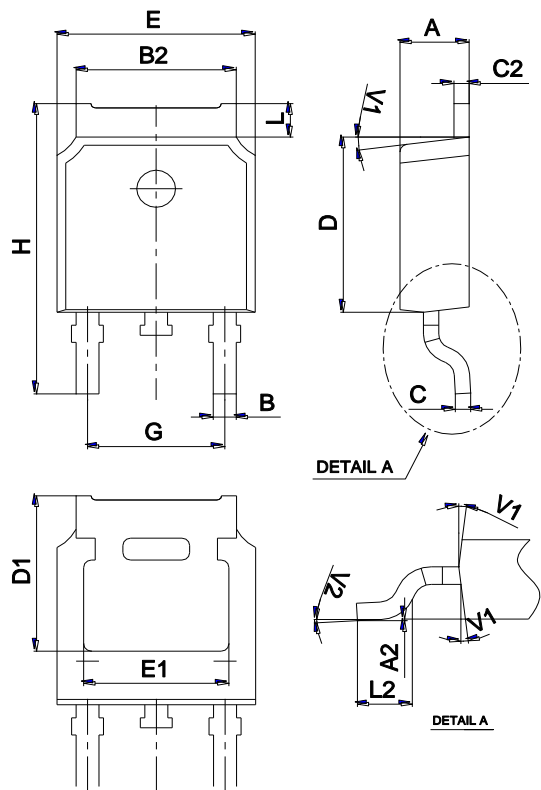

Ref.	Dimensions					
	Millimeters			Inches		
	Min.	Typ.	Max.	Min.	Typ.	Max.
A	2.10		2.50	0.083		0.098
A2	0		0.10	0		0.004
B	0.66		0.86	0.026		0.034
B2	5.18		5.48	0.202		0.216
C	0.40		0.60	0.016		0.024
C2	0.44		0.58	0.017		0.023
D	5.90		6.30	0.232		0.248
D1	5.30REF			0.209REF		
E	6.40		6.80	0.252		0.268
E1	4.63			0.182		
G	4.47		4.67	0.176		0.184
H	9.50		10.70	0.374		0.421
L	1.09		1.21	0.043		0.048
L2	1.35		1.65	0.053		0.065
V1		7°			7°	
V2		0°	6°	0°		6°

Marking

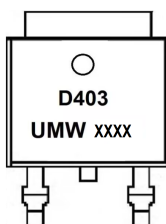

Ordering information

Order code	Package	Baseqty	Deliverymode
UMW AOD403	TO-252	2500	Tape and reel