

Features

N-Ch:

- $V_{DS} (V) = 20V$
- $R_{DS(ON)} < 53m\Omega$ ($V_{GS} = 4.5V$)
- $R_{DS(ON)} < 70m\Omega$ ($V_{GS} = 2.7V$)

P-Ch:

- $V_{DS} (V) = -20V$
- $R_{DS(ON)} < 100m\Omega$ ($V_{GS} = -4.5V$)
- $R_{DS(ON)} < 140m\Omega$ ($V_{GS} = -2.7V$)

- Generation V Technology Ultra
- Low On-Resistance
- Dual N and P Channel Mosfet
- Surface Mount
- Dynamic dv/dt Rating
- Fast Switching
- Lead-Free

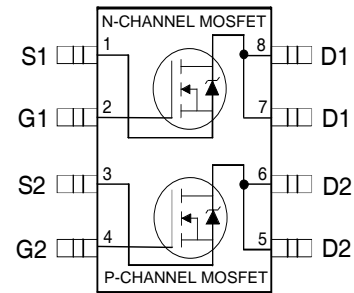

SOP-8

Description

The so-8 has been modified through a customized leadframe for enhanced thermal characteristics and multiple die capability making it ideal in a variety of power applications. With these improvements, multiple devices can be used in an application with dramatically reduced board space. The package is designed for vapor phase, infra red, or wave soldering techniques. Power dissipation of greater than 0.8W is possible in a typical PCB mount application.

Absolute Maximum Ratings

	Parameter	Max.		Units
		N-Channel	P-Channel	
$I_D @ T_A = 25^\circ C$	10 Sec. Pulse Drain Current, $V_{GS} @ 4.5V$	5.7	-4.7	A
$I_D @ T_A = 25^\circ C$	Continuous Drain Current, $V_{GS} @ 4.5V$	5.2	-4.3	
$I_D @ T_A = 70^\circ C$	Continuous Drain Current, $V_{GS} @ 4.5V$	4.1	-3.4	
I_{DM}	Pulsed Drain Current ①	21	-17	
$P_D @ T_A = 25^\circ C$	Power Dissipation	2.0		W
	Linear Derating Factor	0.016		W/°C
V_{GS}	Gate-to-Source Voltage	± 12		V
dv/dt	Peak Diode Recovery dv/dt ②	5.0	-5.0	V/ns
T_J, T_{STG}	Junction and Storage Temperature Range	-55 to + 150		°C

Thermal Resistance Ratings

	Parameter	Typ.	Max.	Units
$R_{\theta JA}$	Maximum Junction-to-Ambient ③		62.5	°C/W

Electrical Characteristics @ T_J = 25°C (unless otherwise specified)

Parameter	Parameter	Min.	Typ.	Max.	Units	Conditions
V _{(BR)DSS}	Drain-to-Source Breakdown Voltage	N-Ch 20 P-Ch -20			V	V _{GS} = 0V, I _D = 250μA V _{GS} = 0V, I _D = -250μA
ΔV _{(BR)DSS} /ΔT _J	Breakdown Voltage Temp. Coefficient	N-Ch P-Ch	0.044 -0.012		V/°C	Reference to 25°C, I _D = 1mA Reference to 25°C, I _D = -1mA
R _{DS(ON)}	Static Drain-to-Source On-Resistance	N-Ch P-Ch		53 70 100 140	mΩ	V _{GS} = 4.5V, I _D = 2.6A ③ V _{GS} = 2.7V, I _D = 2.2A ③ V _{GS} = -4.5V, I _D = -2.2A ③ V _{GS} = -2.7V, I _D = -1.8A ③
V _{GS(th)}	Gate Threshold Voltage	N-Ch P-Ch	0.70 -0.70		V	V _{DS} = V _{GS} , I _D = 250μA V _{DS} = V _{GS} , I _D = -250μA
g _{fs}	Forward Transconductance	N-Ch P-Ch	8.30 4.00		S	V _{DS} = 15V, I _D = 2.6A ③ V _{DS} = -15V, I _D = -2.2A ③
I _{DSS}	Drain-to-Source Leakage Current	N-Ch P-Ch N-Ch P-Ch		1.0 -1.0 25 -25	μA	V _{DS} = 16V, V _{GS} = 0V V _{DS} = -16V, V _{GS} = 0V V _{DS} = 16V, V _{GS} = 0V, T _J = 125°C V _{DS} = -16V, V _{GS} = 0V, T _J = 125°C
I _{GSS}	Gate-to-Source Forward Leakage	N-P		±100		V _{GS} = ± 12V
Q _g	Total Gate Charge	N-Ch P-Ch		20 22	nC	N-Channel I _D = 2.6A, V _{DS} = 16V, V _{GS} = 4.5V
Q _{gs}	Gate-to-Source Charge	N-Ch P-Ch		2.2 3.3		P-Channel ③
Q _{gd}	Gate-to-Drain ("Miller") Charge	N-Ch P-Ch		8.0 9.0		I _D = -2.2A, V _{DS} = -16V, V _{GS} = -4.5V
t _{d(on)}	Turn-On Delay Time	N-Ch P-Ch		9.0 8.4		N-Channel V _{DD} = 10V, I _D = 2.6A, R _G = 6.0Ω, R _D = 3.8Ω
t _r	Rise Time	N-Ch P-Ch		42 26	ns	③
t _{d(off)}	Turn-Off Delay Time	N-Ch P-Ch		32 51		P-Channel V _{DD} = -10V, I _D = -2.2A, R _G = 6.0Ω, R _D = 4.5Ω
t _f	Fall Time	N-Ch P-Ch		51 33		
L _D	Internal Drain Inductance	N-P		4.0	nH	Between lead tip and center of die contact
L _S	Internal Source Inductance	N-P		6.0		
C _{iss}	Input Capacitance	N-Ch P-Ch		660 610		N-Channel V _{GS} = 0V, V _{DS} = 15V, f = 1.0MHz
C _{oss}	Output Capacitance	N-Ch P-Ch		280 310	pF	③
C _{rss}	Reverse Transfer Capacitance	N-Ch P-Ch		140 170		P-Channel V _{GS} = 0V, V _{DS} = -15V, f = 1.0MHz

Source-Drain Ratings and Characteristics

Parameter	Parameter	Min.	Typ.	Max.	Units	Conditions
I _S	Continuous Source Current (Body Diode)	N-Ch P-Ch		2.5 -2.5	A	
I _{SM}	Pulsed Source Current (Body Diode) ①	N-Ch P-Ch		21 -17		
V _{SD}	Diode Forward Voltage	N-Ch P-Ch		1.0 -1.0	V	T _J = 25°C, I _S = 1.8A, V _{GS} = 0V ③ T _J = 25°C, I _S = -1.8A, V _{GS} = 0V ③
t _{rr}	Reverse Recovery Time	N-Ch P-Ch		29 44 56 84	ns	N-Channel T _J = 25°C, I _F = 2.6A, di/dt = 100A/μs
Q _{rr}	Reverse Recovery Charge	N-Ch P-Ch		22 33 71 110	nC	P-Channel T _J = 25°C, I _F = -2.2A, di/dt = 100A/μs ③
t _{on}	Forward Turn-On Time	N-P				Intrinsic turn-on time is negligible (turn-on is dominated by L _S +L _D)

Notes:

- ① Repetitive rating; pulse width limited by max. junction temperature. (See fig. 23)
- ② N-Channel I_{SD} ≤ 2.6A, di/dt ≤ 100A/μs, V_{DD} ≤ V_{(BR)DSS}, T_J ≤ 150°C
P-Channel I_{SD} ≤ -2.2A, di/dt ≤ 50A/μs, V_{DD} ≤ V_{(BR)DSS}, T_J ≤ 150°C
- ③ Pulse width ≤ 300μs; duty cycle ≤ 2%.
- ④ Surface mounted on FR-4 board, t ≤ 10sec.

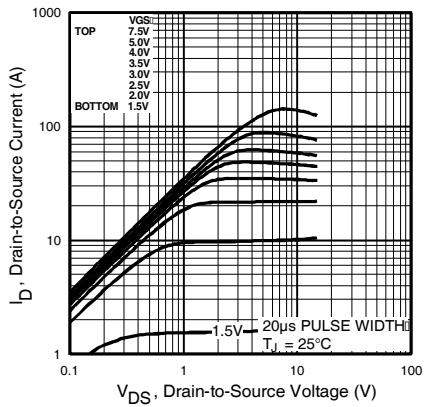

Fig 1. Typical Output Characteristics

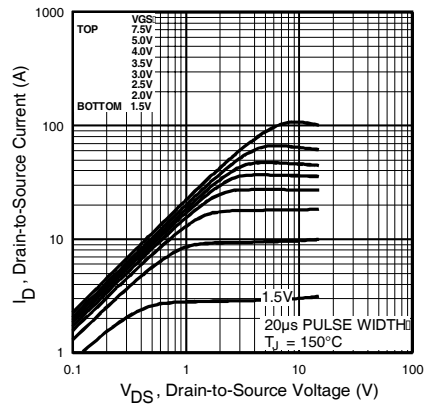

Fig 2. Typical Output Characteristics

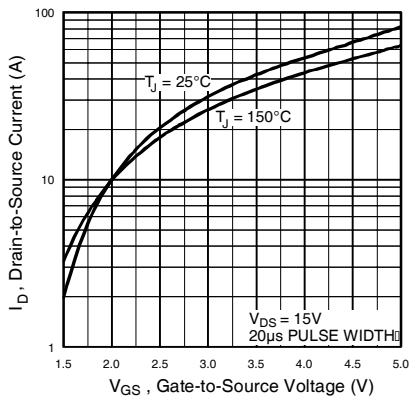

Fig 3. Typical Transfer Characteristics

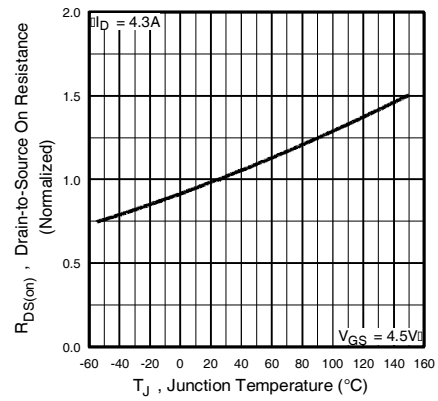

Fig 4. Normalized On-Resistance Vs. Temperature

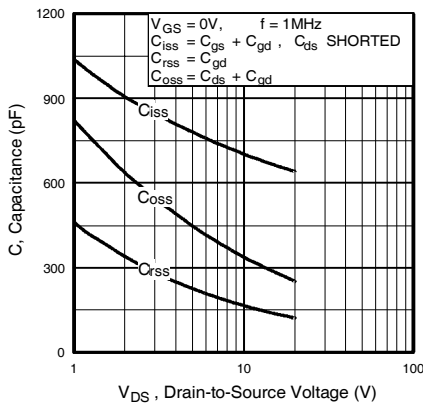

Fig 5. Typical Capacitance Vs. Drain-to-Source Voltage

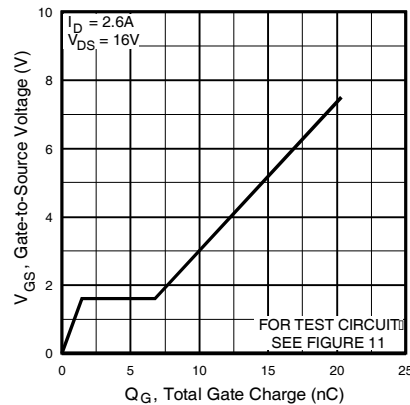

Fig 6. Typical Gate Charge Vs. Gate-to-Source Voltage

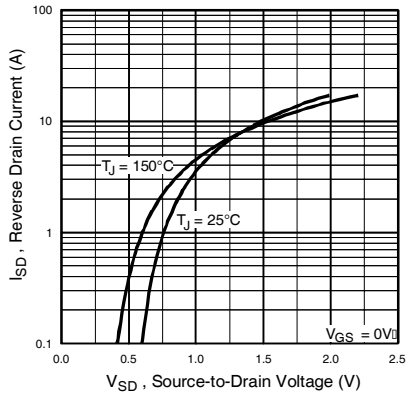

Fig 7. Typical Source-Drain Diode Forward Voltage

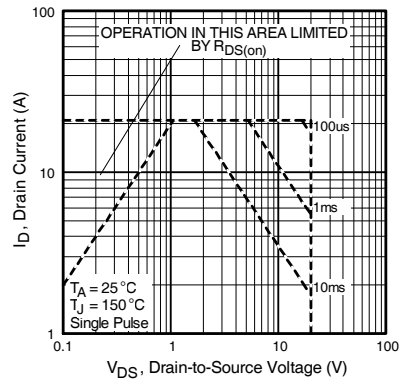

Fig 8. Maximum Safe Operating Area

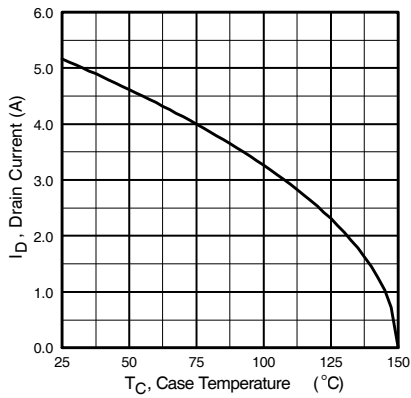

Fig 9. Maximum Drain Current Vs. Ambient Temperature

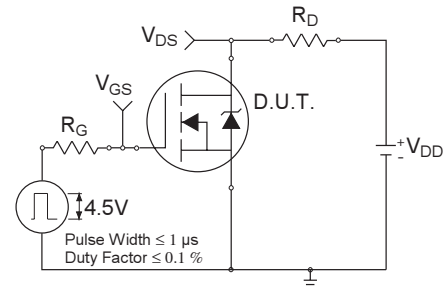

Fig 10a. Switching Time Test Circuit

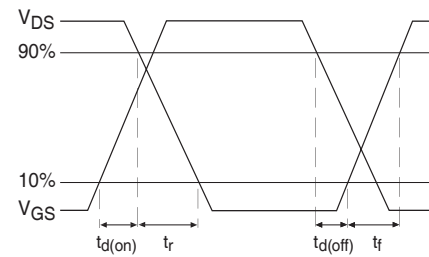

Fig 10b. Switching Time Waveforms

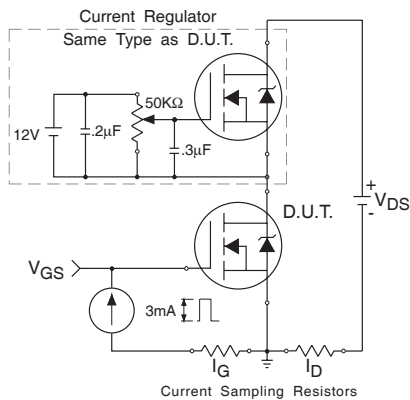

Fig 11a. Gate Charge Test Circuit

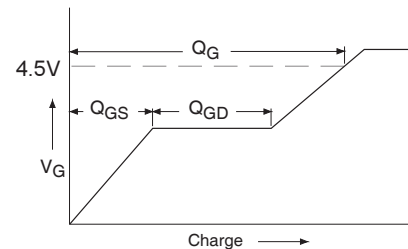

Fig 11b. Basic Gate Charge Waveform

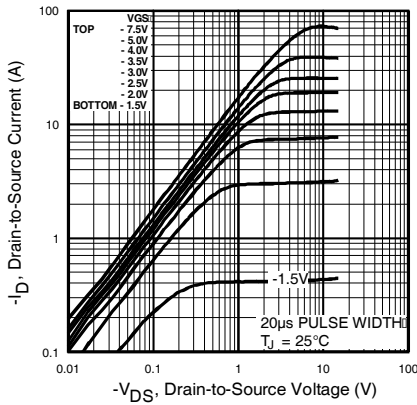

Fig 12. Typical Output Characteristics

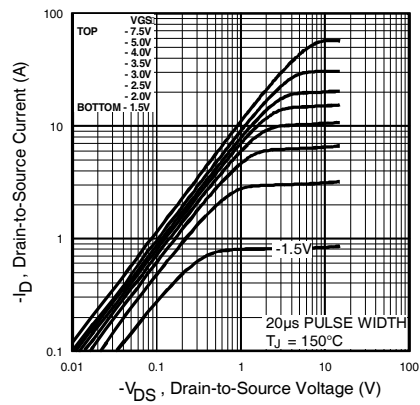

Fig 13. Typical Output Characteristics

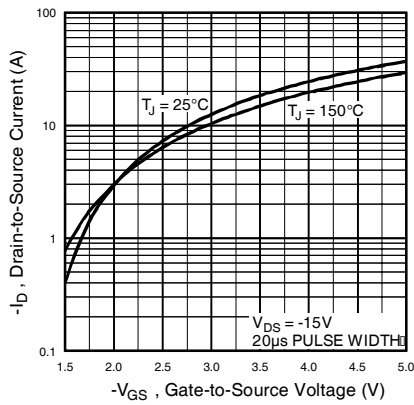

Fig 14. Typical Transfer Characteristics

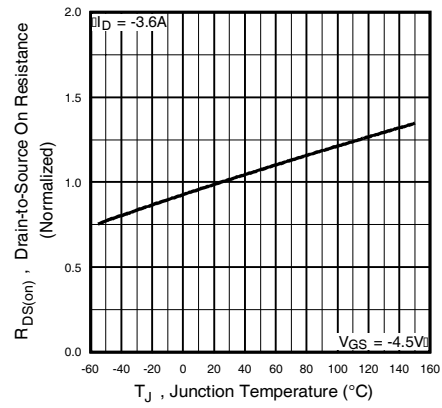

Fig 15. Normalized On-Resistance Vs. Temperature

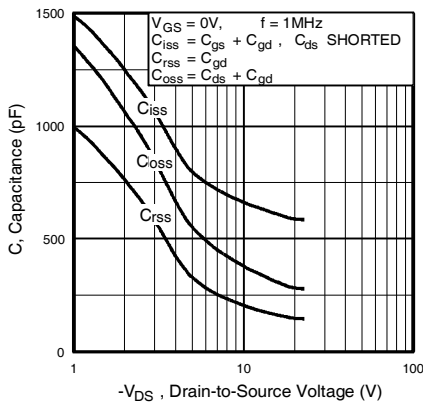

Fig 16. Typical Capacitance Vs. Drain-to-Source Voltage

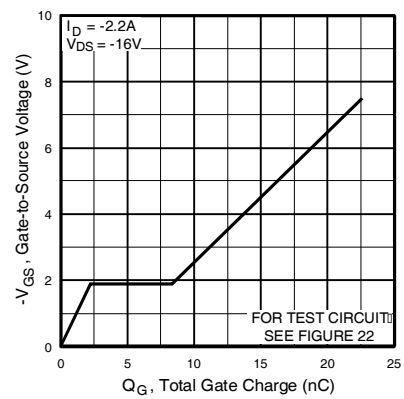

Fig 17. Typical Gate Charge Vs. Gate-to-Source Voltage

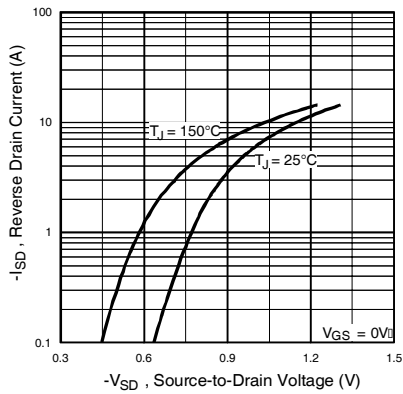

Fig 18. Typical Source-Drain Diode Forward Voltage

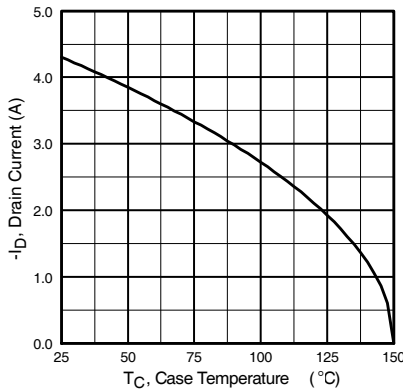

Fig 20. Maximum Drain Current Vs. Ambient Temperature

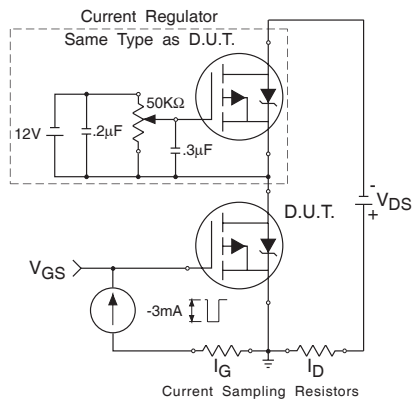

Fig 22a. Gate Charge Test Circuit

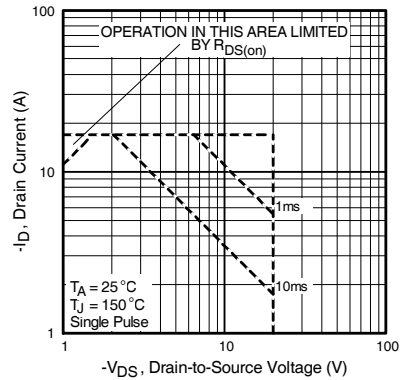

Fig 19. Maximum Safe Operating Area

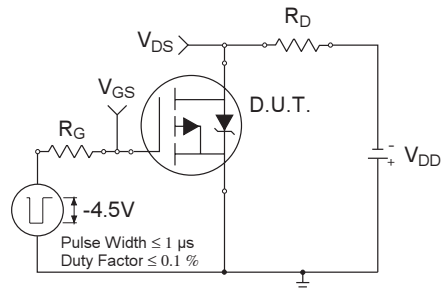

Fig 21a. Switching Time Test Circuit

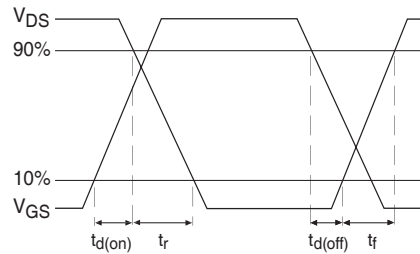

Fig 21b. Switching Time Waveforms

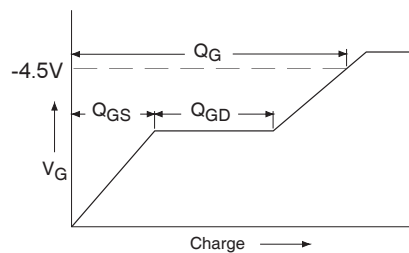

Fig 22b. Basic Gate Charge Waveform

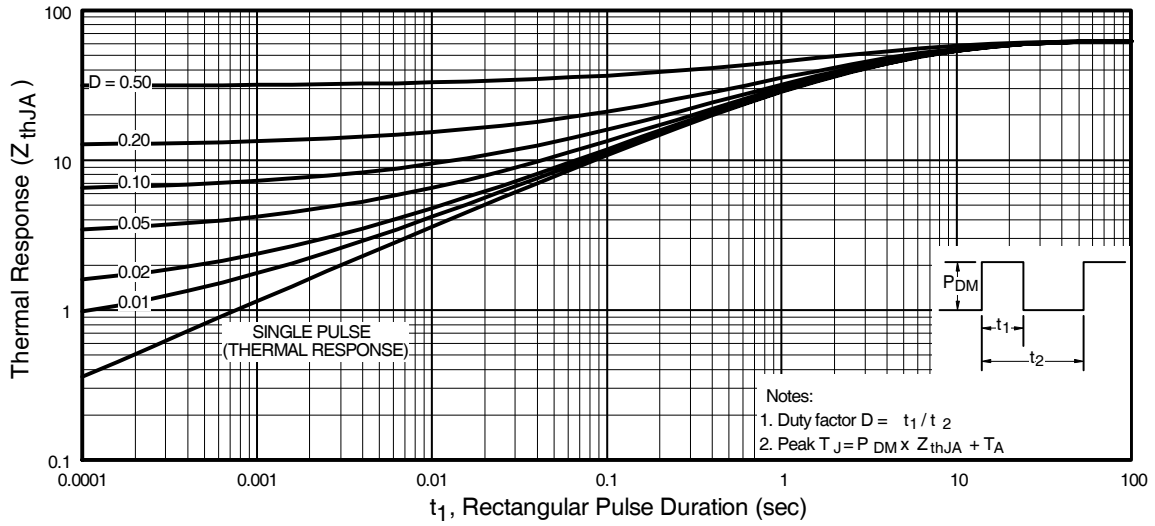
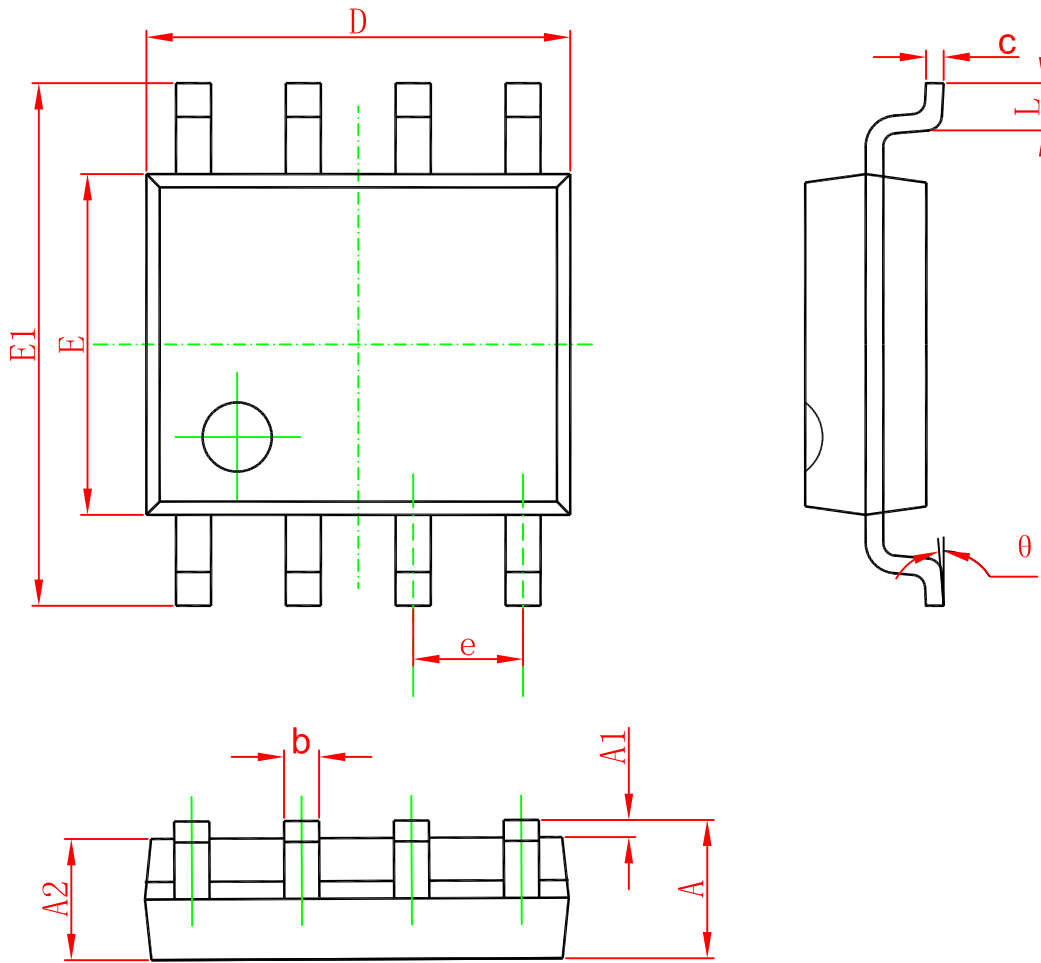

Fig 23. Maximum Effective Transient Thermal Impedance, Junction-to-Ambient

SOP-8



Symbol	Dimensions In Millimeters		Dimensions In Inches	
	Min	Max	Min	Max
A	1.350	1.750	0.053	0.069
A1	0.100	0.250	0.004	0.010
A2	1.350	1.550	0.053	0.061
b	0.330	0.510	0.013	0.020
c	0.170	0.250	0.006	0.010
D	4.700	5.100	0.185	0.200
E	3.800	4.000	0.150	0.157
E1	5.800	6.200	0.228	0.244
e	1.270(BSC)		0.050(BSC)	
L	0.400	1.270	0.016	0.050
θ	0°	8°	0°	8°

Marking

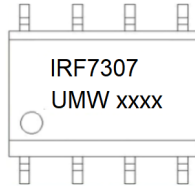

Ordering information

Order code	Package	Baseqty	Deliverymode
UMW IRF7307TR	SOP-8	3000	Tape and reel