

Features

- $V_{DS} (V) = -40V$
- $R_{DS(on)} < 44m\Omega$ ($V_{GS} = -10V$)
- $R_{DS(on)} < 64m\Omega$ ($V_{GS} = -4.5V$)
- High performance trench technology for extremely low $r_{DS(on)}$
- RoHS Compliant

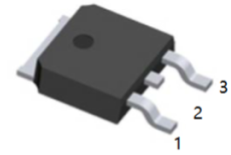

1.G 2.D 3.S
TO-252(DPAK) top view

General Description

This P-Channel MOSFET has been produced technology to deliver low $r_{DS(on)}$ and optimized B_{vds} capability to offer superior performance benefit in the applications.

Application

- Inverter
- Power Supplies

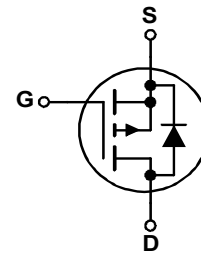

MOSFET Maximum Ratings $T_C = 25^\circ C$ unless otherwise noted

| Symbol | Parameter | Rated | Units |
|----------------|--|-------------|------------|
| V_{DS} | Drain to Source Voltage | -40 | V |
| V_{GS} | Gate to Source Voltage | ± 20 | V |
| I_D | Drain Current -Continuous (Package limited) $T_C = 25^\circ C$ | -14 | A |
| | -Continuous (Silicon limited) $T_C = 25^\circ C$ (Note 1) | -24 | |
| | -Continuous $T_A = 25^\circ C$ (Note 1a) | -6.7 | |
| | -Pulsed | -60 | |
| E_{AS} | Single Pulse Avalanche Energy (Note 3) | 84 | mJ |
| P_D | Power Dissipation $T_C = 25^\circ C$ | 42 | W |
| | Power Dissipation (Note 1a) | 3 | |
| T_J, T_{STG} | Operating and Storage Junction Temperature Range | -55 to +150 | $^\circ C$ |

Thermal Characteristics

| | | | |
|-----------------|---|-----|--------------|
| $R_{\theta JC}$ | Thermal Resistance, Junction to Case | 3.0 | $^\circ C/W$ |
| $R_{\theta JA}$ | Thermal Resistance, Junction to Ambient (Note 1a) | 40 | |

Electrical Characteristics $T_J = 25^\circ\text{C}$ unless otherwise noted

| Symbol | Parameter | Test Conditions | Min | Typ | Max | Units |
|--------|-----------|-----------------|-----|-----|-----|-------|
|--------|-----------|-----------------|-----|-----|-----|-------|

Off Characteristics

| | | | | | | |
|--------------------------------------|---|--|-----|-----|------------|----------------------|
| BV_{DSS} | Drain to Source Breakdown Voltage | $I_D = -250\mu\text{A}, V_{GS} = 0\text{V}$ | -40 | | | V |
| $\frac{\Delta BV_{DSS}}{\Delta T_J}$ | Breakdown Voltage Temperature Coefficient | $I_D = -250\mu\text{A}$, referenced to 25°C | | -32 | | mV/ $^\circ\text{C}$ |
| I_{DSS} | Zero Gate Voltage Drain Current | $V_{DS} = -32\text{V},$ $V_{GS} = 0\text{V}$ $T_J = 125^\circ\text{C}$ | | | -1 -100 | μA |
| I_{GSS} | Gate to Source Leakage Current | $V_{GS} = \pm 20\text{V}, V_{DS} = 0\text{V}$ | | | ± 100 | nA |

On Characteristics

| | | | | | | |
|--|--|--|------|------|------|----------------------|
| $V_{GS(th)}$ | Gate to Source Threshold Voltage | $V_{GS} = V_{DS}, I_D = -250\mu\text{A}$ | -1.4 | -1.6 | -3.0 | V |
| $\frac{\Delta V_{GS(th)}}{\Delta T_J}$ | Gate to Source Threshold Voltage Temperature Coefficient | $I_D = -250\mu\text{A}$, referenced to 25°C | | 4.7 | | mV/ $^\circ\text{C}$ |
| $r_{DS(on)}$ | Drain to Source On Resistance | $V_{GS} = -10\text{V}, I_D = -6.7\text{A}$ | | 36 | 44 | m Ω |
| | | $V_{GS} = -4.5\text{V}, I_D = -5.5\text{A}$ | | 48 | 64 | |
| g_{FS} | Forward Transconductance | $V_{DS} = -5\text{V}, I_D = -6.7\text{A}$ | | 16 | | S |

Dynamic Characteristics

| | | | | | | |
|-----------|------------------------------|--|--|------|------|----------|
| C_{iss} | Input Capacitance | $V_{DS} = -20\text{V}, V_{GS} = 0\text{V},$ $f = 1\text{MHz}$ | | 1165 | 1550 | pF |
| C_{oss} | Output Capacitance | | | 165 | 220 | pF |
| C_{rss} | Reverse Transfer Capacitance | | | 90 | 135 | pF |
| R_g | Gate Resistance | $f = 1\text{MHz}$ | | 4 | | Ω |

Switching Characteristics

| | | | | | | |
|--------------|-------------------------------|---|--|-----|----|----|
| $t_{d(on)}$ | Turn-On Delay Time | $V_{DD} = -20\text{V}, I_D = -6.7\text{A}$ $V_{GS} = -10\text{V}, R_{GEN} = 6\Omega$ | | 6 | 12 | ns |
| t_r | Rise Time | | | 15 | 26 | ns |
| $t_{d(off)}$ | Turn-Off Delay Time | | | 22 | 35 | ns |
| t_f | Fall Time | | | 7 | 14 | ns |
| $Q_{g(TOT)}$ | Total Gate Charge at 10V | $V_{DD} = -20\text{V}, I_D = -6.7\text{A}$ $V_{GS} = -10\text{V}$ | | 21 | 29 | nC |
| Q_{gs} | Gate to Source Gate Charge | | | 3.4 | | nC |
| Q_{gd} | Gate to Drain "Miller" Charge | | | 4 | | nC |

Drain-Source Diode Characteristics

| | | | | | | |
|----------|---------------------------------------|---|--|------|-----|----|
| V_{SD} | Source to Drain Diode Forward Voltage | $V_{GS} = 0\text{V}, I_S = -6.7\text{A}$ (Note 2) | | 0.86 | 1.2 | V |
| t_{rr} | Reverse Recovery Time | $I_F = -6.7\text{A}, di/dt = 100\text{A}/\mu\text{s}$ | | 29 | 43 | ns |
| Q_{rr} | Reverse Recovery Charge | | | 30 | 44 | nC |

Notes:

- 1: $R_{\theta JA}$ is sum of junction-to-case and case-to-ambient thermal resistance where the case thermal reference is defined as the solder mounting surface of the drain pins. $R_{\theta JC}$ is guaranteed by design while $R_{\theta JC}$ is determined by the user's board design.
 - a. $40^\circ\text{C}/\text{W}$ when mounted on a 1 in^2 pad of 2 oz copper
 - b. $96^\circ\text{C}/\text{W}$ when mounted on a minimum pad.
- 2: Pulse Test: Pulse Width $< 300\mu\text{s}$, Duty cycle $< 2.0\%$.
- 3: Starting $T_J = 25^\circ\text{C}$, $L = 3\text{mH}$, $I_{AS} = 7.5\text{A}$, $V_{DD} = 40\text{V}$, $V_{GS} = 10\text{V}$.

Typical Characteristics $T_J = 25^\circ\text{C}$ unless otherwise noted

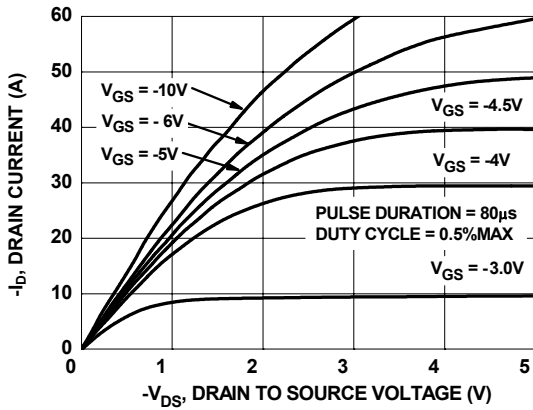

Figure 1. On Region Characteristics

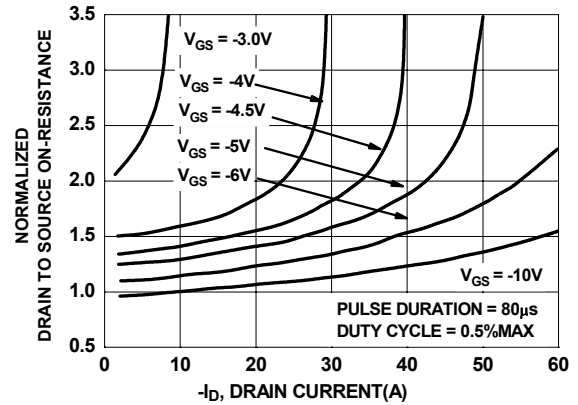

Figure 2. Normalized On-Resistance vs Drain Current and Gate Voltage

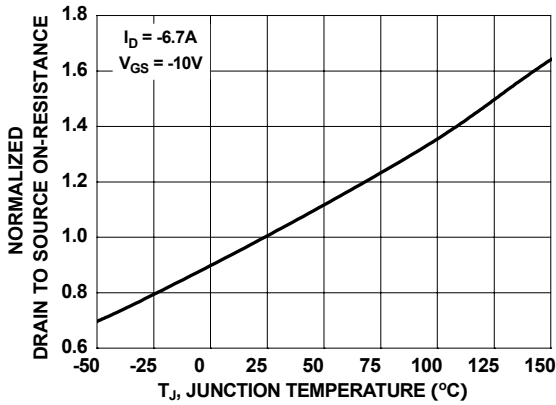

Figure 3. Normalized On Resistance vs Junction Temperature

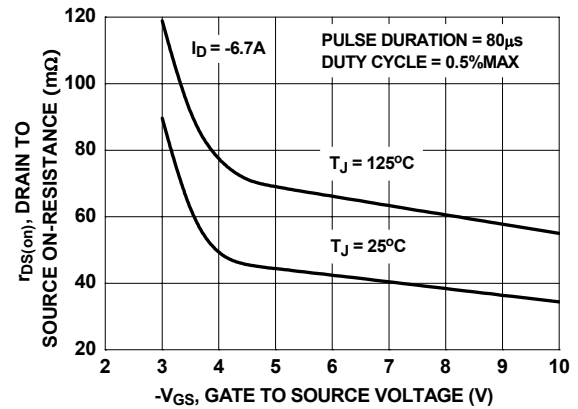

Figure 4. On-Resistance vs Gate to Source Voltage

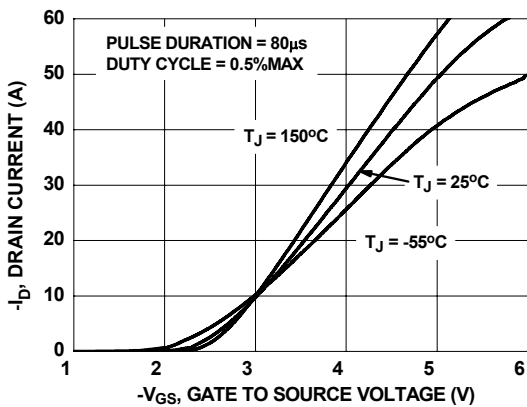

Figure 5. Transfer Characteristics

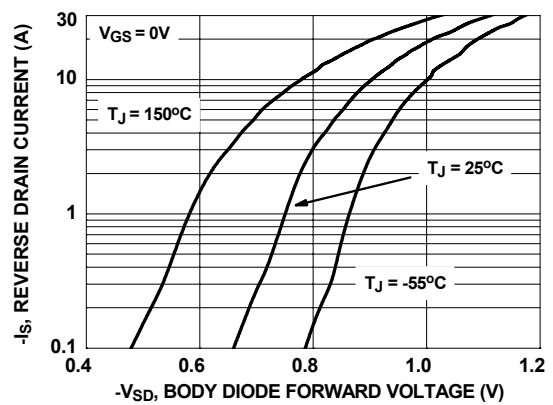

Figure 6. Source to Drain Diode Forward Voltage vs Source Current

Typical Characteristics $T_J = 25^\circ\text{C}$ unless otherwise noted

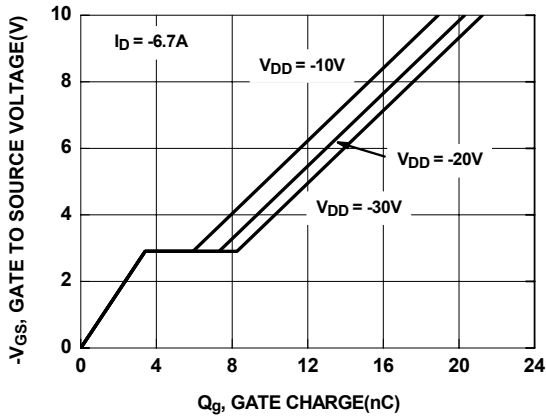

Figure 7. Gate Charge Characteristics

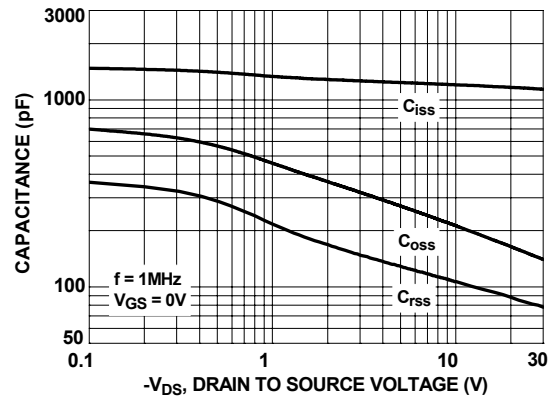

Figure 8. Capacitance vs Drain to Source Voltage

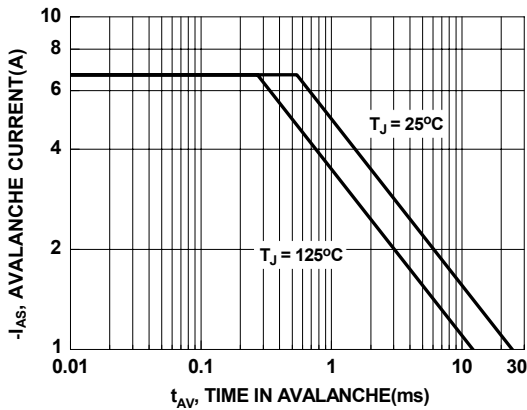

Figure 9. Unclamped Inductive Switching Capability

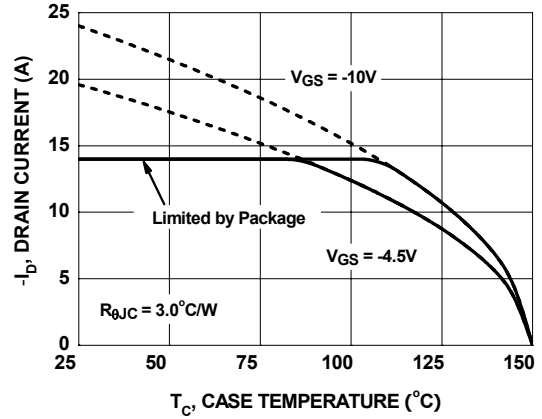

Figure 10. Maximum Continuous Drain Current vs Case Temperature

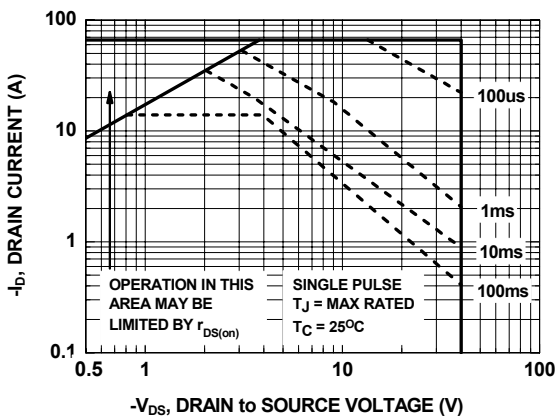

Figure 11. Forward Bias Safe Operating Area

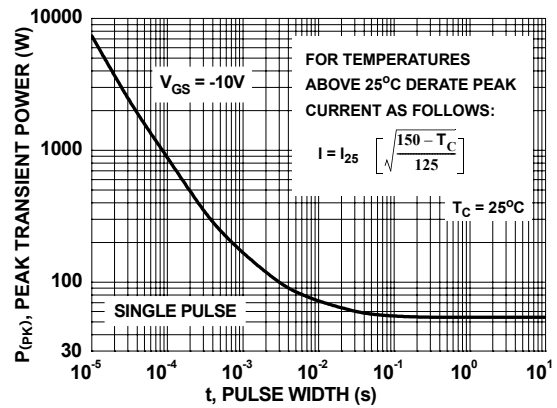

Figure 12. Single Pulse Maximum Power Dissipation

Typical Characteristics $T_J = 25^\circ\text{C}$ unless otherwise noted

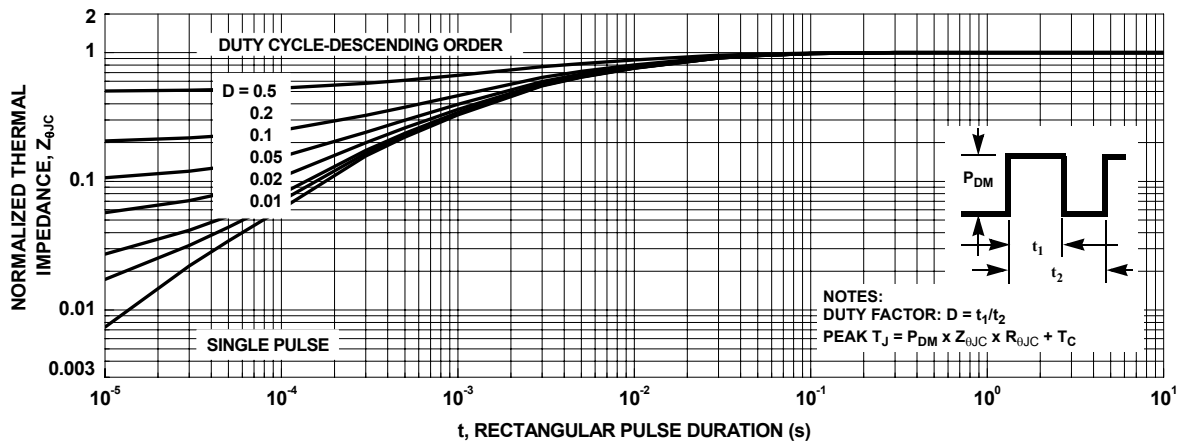
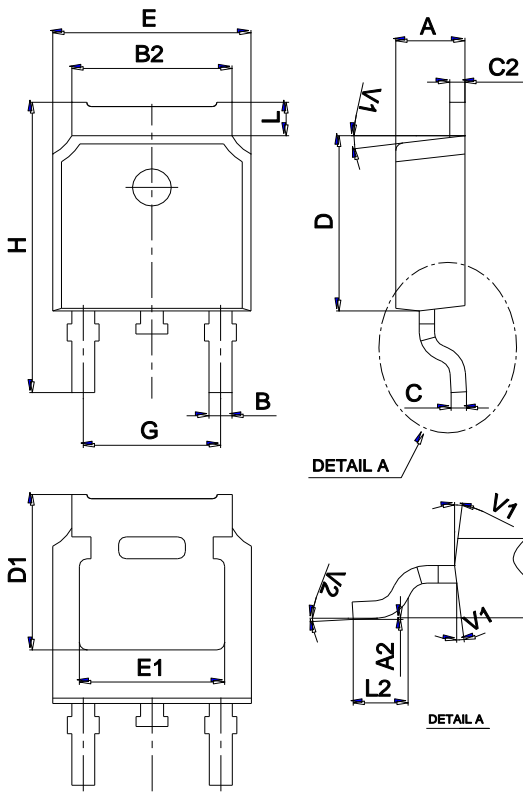

Figure 13. Transient Thermal Response Curve

Package Mechanical Data TO-252



| Ref. | Dimensions | | | | | |
|------|-------------|------|-------|----------|------|-------|
| | Millimeters | | | Inches | | |
| | Min. | Typ. | Max. | Min. | Typ. | Max. |
| A | 2.10 | | 2.50 | 0.083 | | 0.098 |
| A2 | 0 | | 0.10 | 0 | | 0.004 |
| B | 0.66 | | 0.86 | 0.026 | | 0.034 |
| B2 | 5.18 | | 5.48 | 0.202 | | 0.216 |
| C | 0.40 | | 0.60 | 0.016 | | 0.024 |
| C2 | 0.44 | | 0.58 | 0.017 | | 0.023 |
| D | 5.90 | | 6.30 | 0.232 | | 0.248 |
| D1 | 5.30REF | | | 0.209REF | | |
| E | 6.40 | | 6.80 | 0.252 | | 0.268 |
| E1 | 4.63 | | | 0.182 | | |
| G | 4.47 | | 4.67 | 0.176 | | 0.184 |
| H | 9.50 | | 10.70 | 0.374 | | 0.421 |
| L | 1.09 | | 1.21 | 0.043 | | 0.048 |
| L2 | 1.35 | | 1.65 | 0.053 | | 0.065 |
| V1 | | 7° | | | 7° | |
| V2 | 0° | | 6° | 0° | | 6° |

Marking

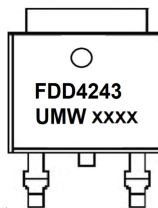

Ordering information

| Order code | Package | Baseqty | Deliverymode |
|-------------|---------|---------|---------------|
| UMW FDD4243 | TO-252 | 2500 | Tape and reel |