

Typical Applications

- Power Supplies
- Converters
- Power Motor Controls
- Bridge Circuits

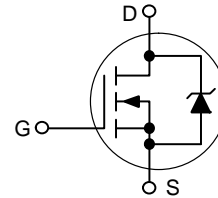

Features

V_{DS}	60V
I_D (at $V_{GS}=10V$)	20A
$R_{DS(ON)}$ (at $V_{GS}=4.5V$)	< 35m Ω

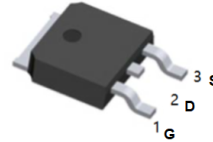

TO-252(DPAK) top view

MAXIMUM RATINGS ($T_J = 25^\circ C$ unless otherwise noted)

Rating		Symbol	Value	Unit
Drain-to-Source Voltage		V_{DSS}	60	Vdc
Drain-to-Gate Voltage ($R_{GS} = 10 M\Omega$)		V_{DGR}	60	Vdc
Gate-to-Source Voltage	Continuous	V_{GS}	± 15	Vdc
	Non-repetitive ($t_p \leq 10$ ms)	V_{GS}	± 20	
Drain Current	Continuous @ $T_A = 25^\circ C$	I_D	20	Adc
	Continuous @ $T_A = 100^\circ C$	I_D	10	
	Single Pulse ($t_p \leq 10 \mu s$)	I_{DM}	60	Apk
Total Power Dissipation @ $T_A = 25^\circ C$		P_D	60	W
Derate above $25^\circ C$			0.40	W/°C
Total Power Dissipation @ $T_A = 25^\circ C$ (Note 1)			1.88	W
Total Power Dissipation @ $T_A = 25^\circ C$ (Note 2)			1.36	W
Operating and Storage Temperature Range		T_J, T_{stg}	-55 to +175	°C
Single Pulse Drain-to-Source Avalanche Energy – Starting $T_J = 25^\circ C$ ($V_{DD} = 25$ Vdc, $V_{GS} = 5.0$ Vdc, $L = 1.0$ mH, $I_L(pk) = 16$ A, $V_{DS} = 60$ Vdc)		E_{AS}	128	mJ
Thermal Resistance	Junction-to-Case	$R_{\theta JC}$	2.5	°C/W
	Junction-to-Ambient (Note 1)	$R_{\theta JA}$	80	
	Junction-to-Ambient (Note 2)	$R_{\theta JA}$	110	
Maximum Lead Temperature for Soldering Purposes, 1/8 in from case for 10 seconds		T_L	260	°C

Stresses exceeding those listed in the Maximum Ratings table may damage the device. If any of these limits are exceeded, device functionality should not be assumed, damage may occur and reliability may be affected.

1. When surface mounted to an FR4 board using 1 in pad size, (Cu Area 1.127 in²).
2. When surface mounted to an FR4 board using recommended pad size, (Cu Area 0.412 in²).

ELECTRICAL CHARACTERISTICS ($T_J = 25^\circ\text{C}$ unless otherwise noted)

Characteristic	Symbol	Min	Typ	Max	Unit	
OFF CHARACTERISTICS						
Drain-to-Source Breakdown Voltage (Note 3) ($V_{GS} = 0\text{ Vdc}$, $I_D = 250\ \mu\text{Adc}$) Temperature Coefficient (Positive)	$V_{(BR)DSS}$	60 –	71.3 71.2	– –	Vdc mV/°C	
Zero Gate Voltage Drain Current ($V_{DS} = 60\text{ Vdc}$, $V_{GS} = 0\text{ Vdc}$) ($V_{DS} = 60\text{ Vdc}$, $V_{GS} = 0\text{ Vdc}$, $T_J = 150^\circ\text{C}$)	I_{DSS}	– –	– –	1.0 10	μAdc	
Gate-Body Leakage Current ($V_{GS} = \pm 15\text{ Vdc}$, $V_{DS} = 0\text{ Vdc}$)	I_{GSS}	–	–	± 100	nAdc	
ON CHARACTERISTICS (Note 3)						
Gate Threshold Voltage (Note 3) ($V_{DS} = V_{GS}$, $I_D = 250\ \mu\text{Adc}$) Threshold Temperature Coefficient (Negative)	$V_{GS(th)}$	1.0 –	1.6 4.6	2.0 –	Vdc mV/°C	
Static Drain-to-Source On-Resistance (Note 3) ($V_{GS} = 4.5\text{ Vdc}$, $I_D = 10\text{ Adc}$)	$R_{DS(on)}$	–	35	45	m Ω	
Static Drain-to-Source On-Resistance (Note 3) ($V_{GS} = 5.0\text{ Vdc}$, $I_D = 20\text{ Adc}$) ($V_{GS} = 5.0\text{ Vdc}$, $I_D = 10\text{ Adc}$, $T_J = 150^\circ\text{C}$)	$V_{DS(on)}$	– –	0.81 0.72	1.66 –	Vdc	
Forward Transconductance (Note 3) ($V_{DS} = 4.0\text{ Vdc}$, $I_D = 10\text{ Adc}$)	g_{FS}	–	17.5	–	mhos	
DYNAMIC CHARACTERISTICS						
Input Capacitance	$(V_{DS} = 25\text{ Vdc}$, $V_{GS} = 0\text{ Vdc}$, $f = 1.0\text{ MHz}$)	C_{iss}	–	707	990	pF
Output Capacitance		C_{oss}	–	224	320	
Transfer Capacitance		C_{rSS}	–	72	105	
SWITCHING CHARACTERISTICS (Note 4)						
Turn-On Delay Time	$(V_{DD} = 30\text{ Vdc}$, $I_D = 20\text{ Adc}$, $V_{GS} = 5.0\text{ Vdc}$, $R_G = 9.1\ \Omega$) (Note 3)	$t_{d(on)}$	–	9.6	20	ns
Rise Time		t_r	–	98	200	
Turn-Off Delay Time		$t_{d(off)}$	–	25	50	
Fall Time		t_f	–	62	120	
Gate Charge	$(V_{DS} = 48\text{ Vdc}$, $I_D = 20\text{ Adc}$, $V_{GS} = 5.0\text{ Vdc}$) (Note 3)	Q_T	–	16.6	32	nC
		Q_1	–	5.5	–	
		Q_2	–	8.5	–	
SOURCE-DRAIN DIODE CHARACTERISTICS						
Forward On-Voltage	$(I_S = 20\text{ Adc}$, $V_{GS} = 0\text{ Vdc}$) (Note 3) $(I_S = 20\text{ Adc}$, $V_{GS} = 0\text{ Vdc}$, $T_J = 150^\circ\text{C}$)	V_{SD}	– –	0.97 0.85	1.2 –	Vdc
Reverse Recovery Time	$(I_S = 20\text{ Adc}$, $V_{GS} = 0\text{ Vdc}$, $di_S/dt = 100\text{ A}/\mu\text{s}$) (Note 3)	t_{rr}	–	42	–	ns
		t_a	–	30	–	
		t_b	–	12	–	
Reverse Recovery Stored Charge		Q_{RR}	–	0.066	–	μC

Product parametric performance is indicated in the Electrical Characteristics for the listed test conditions, unless otherwise noted. Product performance may not be indicated by the Electrical Characteristics if operated under different conditions.

3. Pulse Test: Pulse Width $\leq 300\ \mu\text{s}$, Duty Cycle $\leq 2\%$.

4. Switching characteristics are independent of operating junction temperatures.

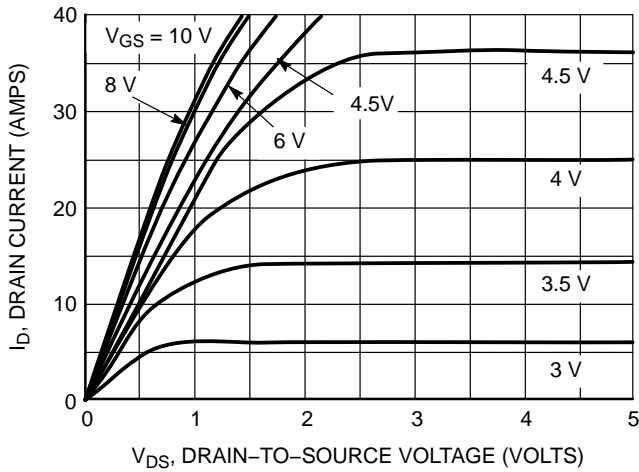

Figure 1. On-Region Characteristics

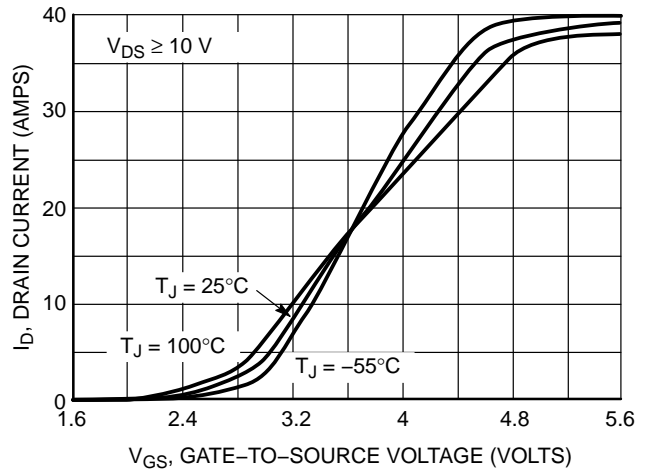

Figure 2. Transfer Characteristics

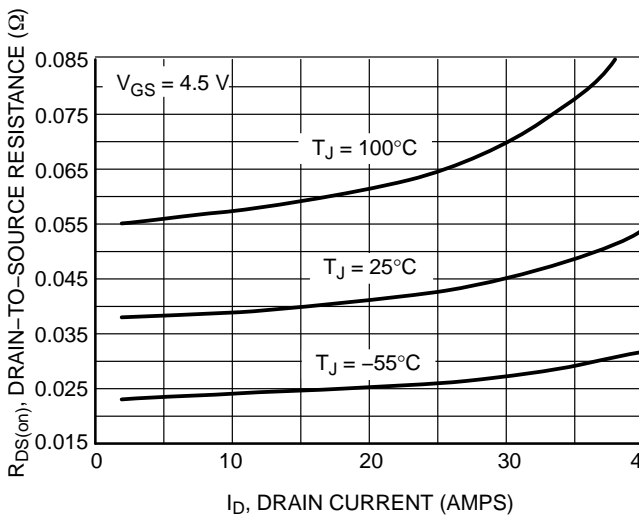

Figure 3. On-Resistance versus Gate-to-Source Voltage

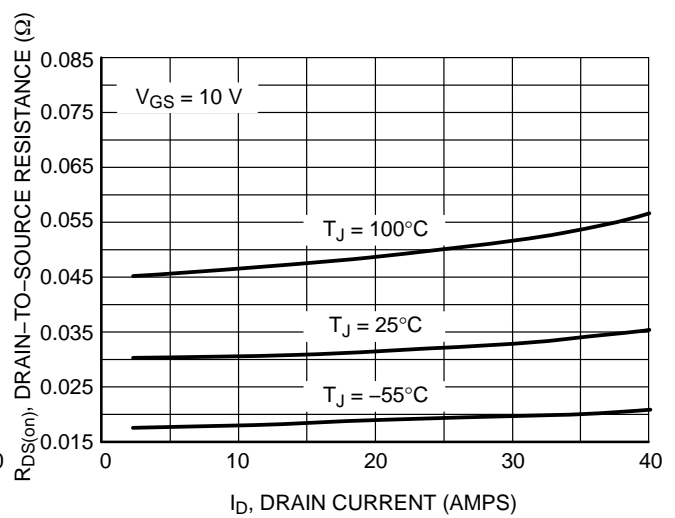

Figure 4. On-Resistance versus Drain Current and Gate Voltage

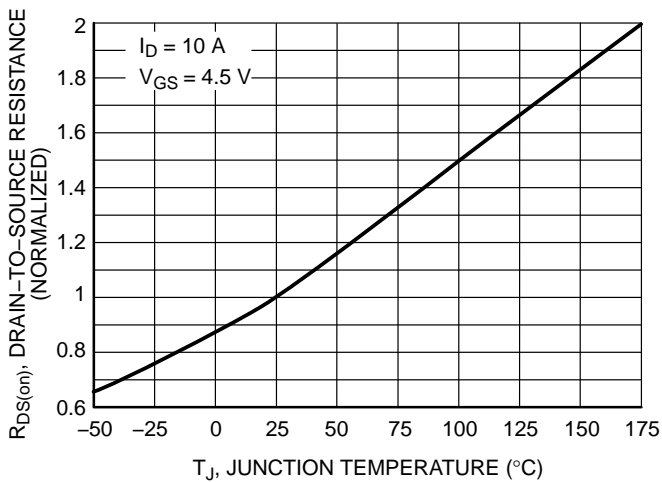

Figure 5. On-Resistance Variation with Temperature

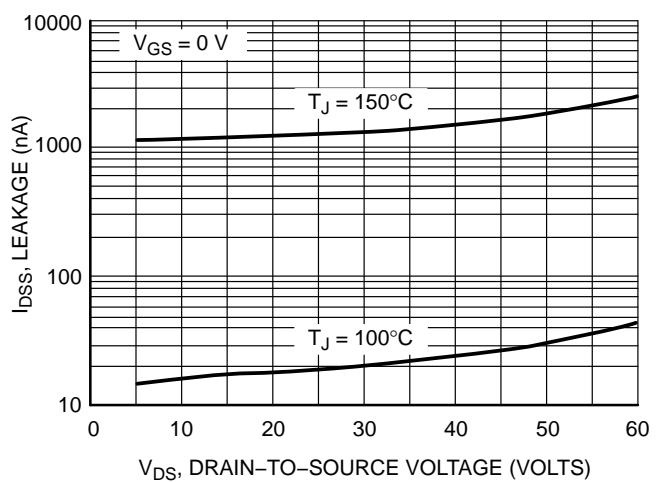

Figure 6. Drain-to-Source Leakage Current versus Voltage

60V N-Channel MOSFET

Switching behavior is most easily modeled and predicted by recognizing that the power MOSFET is charge controlled. The lengths of various switching intervals (t) are determined by how fast the FET input capacitance can be charged by current from the generator.

The published capacitance data is difficult to use for calculating rise and fall because drain-gate capacitance varies greatly with applied voltage. Accordingly, gate charge data is used. In most cases, a satisfactory estimate of average input current (I_{G(AV)}) can be made from a rudimentary analysis of the drive circuit so that

$$t = Q/I_{G(AV)}$$

During the rise and fall time interval when switching a resistive load, V_{GS} remains virtually constant at a level known as the plateau voltage, V_{GS(P)}. Therefore, rise and fall times may be approximated by the following:

$$t_r = Q_2 \times R_G / (V_{GG} - V_{GS(P)})$$

$$t_f = Q_2 \times R_G / V_{GS(P)}$$

where V_{GG} = the gate drive voltage, which varies from zero to V_{GG} R_G = the gate drive resistance and Q₂ and V_{GS(P)} are read from the gate charge curve. During the turn-on and turn-off delay times, gate current is not constant. The simplest calculation uses appropriate values from the capacitance curves in a standard equation for voltage change in an RC network. The equations are:

$$t_{d(on)} = R_G C_{iss} \ln [V_{GG}/(V_{GG} - V_{GS(P)})]$$

$$t_{d(off)} = R_G C_{iss} \ln (V_{GG}/V_{GS(P)})$$

The capacitance (C_{iss}) is read from the capacitance curve at a voltage corresponding to the off-state condition when calculating t_{d(on)} and is read at a voltage corresponding to the on-state when calculating t_{d(off)}.

At high switching speeds, parasitic circuit elements complicate the analysis. The inductance of the MOSFET source lead, inside the package and in the circuit wiring which is common to both the drain and gate current paths, produces a voltage at the source which reduces the gate drive current. The voltage is determined by L di/dt, but since di/dt is a function of drain current, the mathematical solution is complex. The MOSFET output capacitance also complicates the mathematics. And finally, MOSFETs have finite internal gate resistance which effectively adds to the resistance of the driving source, but the internal resistance is difficult to measure and, consequently, is not specified.

The resistive switching time variation versus gate resistance (Figure 9) shows how typical switching performance is affected by the parasitic circuit elements. If the parasitics were not present, the slope of the curves would maintain a value of unity regardless of the switching speed. The circuit used to obtain the data is constructed to minimize common inductance in the drain and gate circuit loops and is believed readily achievable with board mounted components. Most power electronic loads are inductive; the data in the figure is taken with a resistive load, which approximates an optimally snubbed inductive load. Power MOSFETs may be safely operated into an inductive load; however, snubbing reduces switching losses.

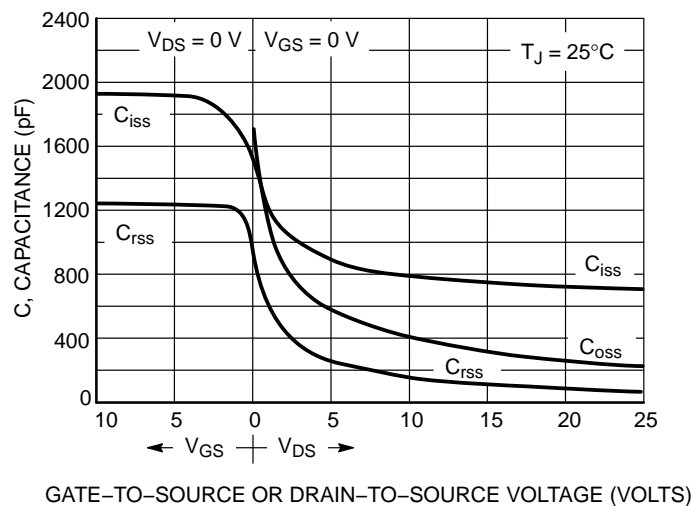

Figure 7. Capacitance Variation

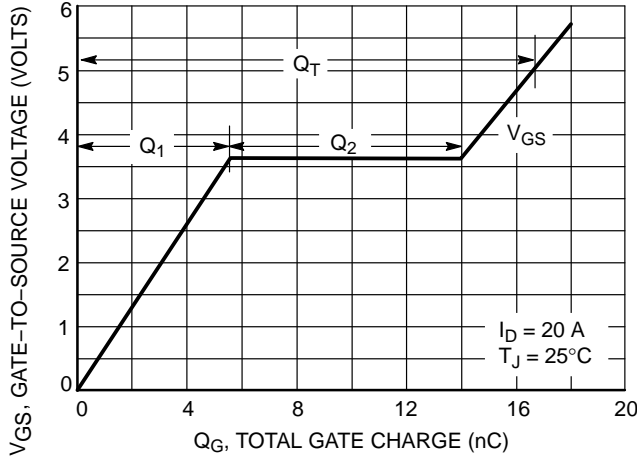

Figure 8. Gate-To-Source and Drain-To-Source Voltage versus Total Charge

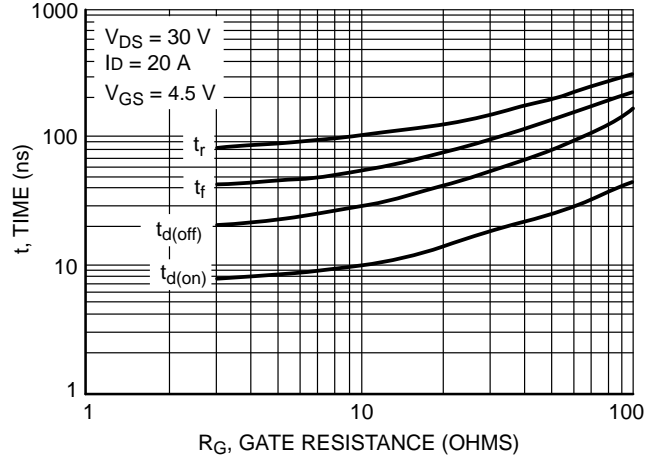

Figure 9. Resistive Switching Time Variation versus Gate Resistance

DRAIN-TO-SOURCE DIODE CHARACTERISTICS

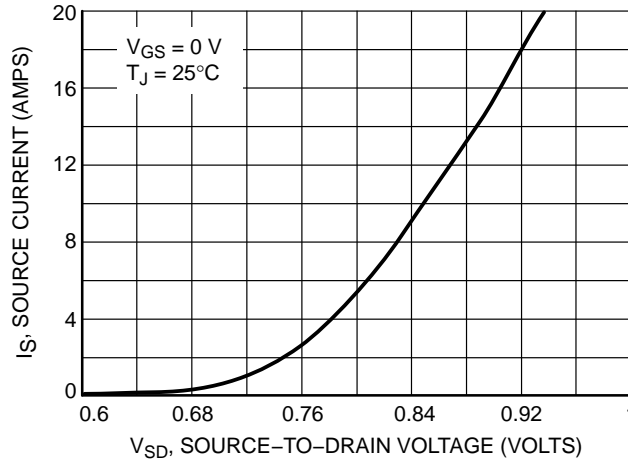

Figure 10. Diode Forward Voltage versus Current

SAFE OPERATING AREA

The Forward Biased Safe Operating Area curves define the maximum simultaneous drain-to-source voltage and drain current that a transistor can handle safely when it is forward biased. Curves are based upon maximum peak junction temperature and a case temperature (T_C) of 25°C. Peak repetitive pulsed power limits are determined by using the thermal response data in conjunction with the procedures discussed in AN569, "Transient Thermal Resistance – General Data and Its Use."

Switching between the off-state and the on-state may traverse any load line provided neither rated peak current (I_{DM}) nor rated voltage (V_{DSS}) is exceeded and the transition time (t_r, t_f) do not exceed 10 s. In addition the total power averaged over a complete switching cycle must not exceed $(T_{J(MAX)} - T_C)/(R_{JC})$.

A Power MOSFET designated E-FET can be safely used in switching circuits with unclamped inductive loads. For

reliable operation, the stored energy from circuit inductance dissipated in the transistor while in avalanche must be less than the rated limit and adjusted for operating conditions differing from those specified. Although industry practice is to rate in terms of energy, avalanche energy capability is not a constant. The energy rating decreases non-linearly with an increase of peak current in avalanche and peak junction temperature.

Although many E-FETs can withstand the stress of drain-to-source avalanche at currents up to rated pulsed current (I_{DM}), the energy rating is specified at rated continuous current (I_D), in accordance with industry custom. The energy rating must be derated for temperature as shown in the accompanying graph (Figure 12). Maximum energy at currents below rated continuous I_D can safely be assumed to equal the values indicated.

SAFE OPERATING AREA

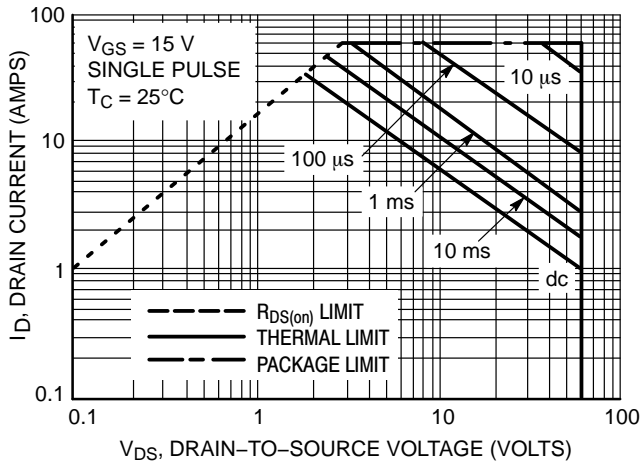

Figure 11. Maximum Rated Forward Biased Safe Operating Area

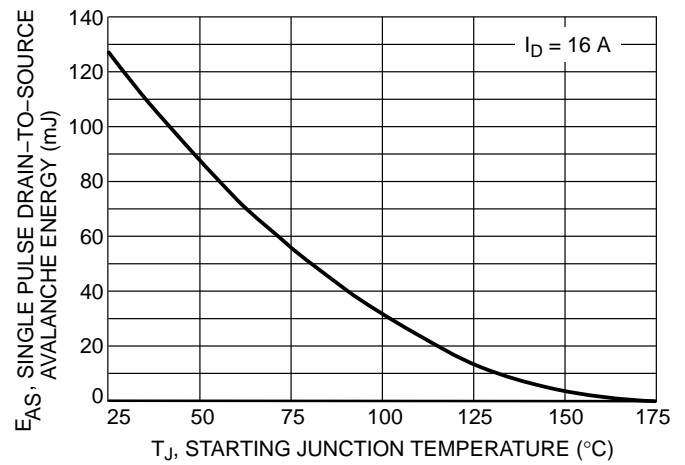

Figure 12. Maximum Avalanche Energy versus Starting Junction Temperature

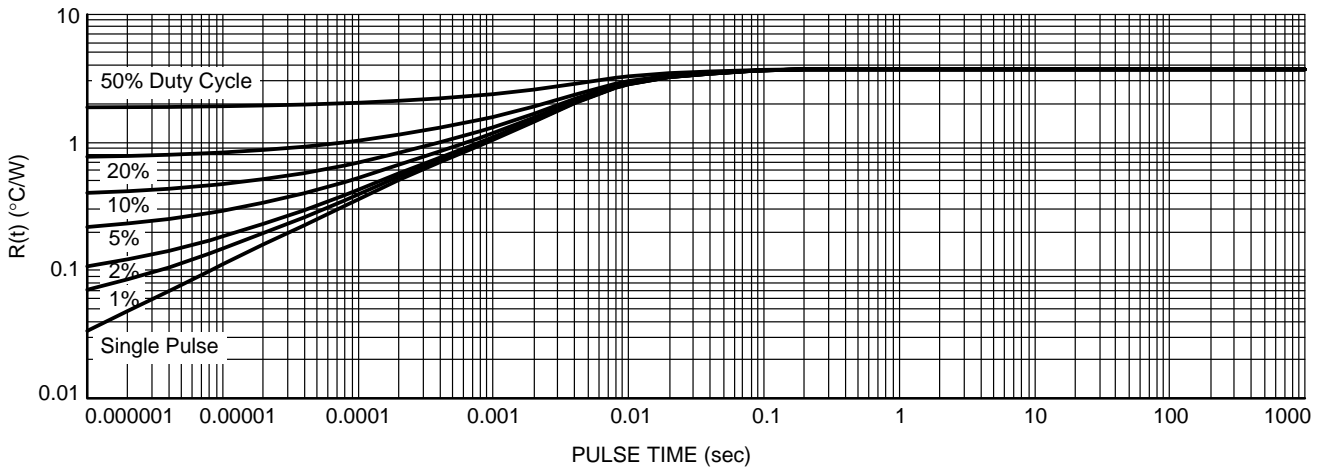

Figure 13. Thermal Response

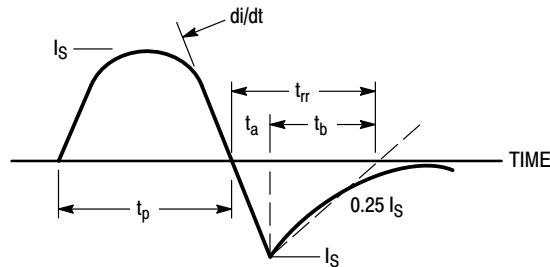
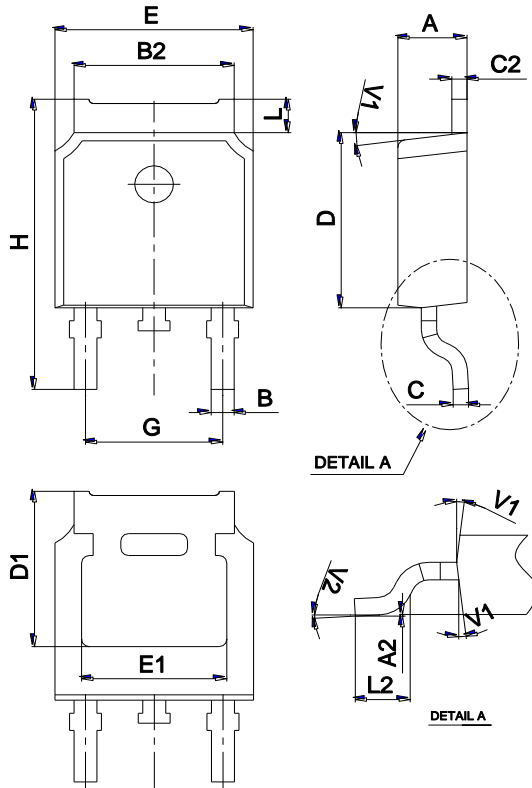

Figure 14. Diode Reverse Recovery Waveform

Package Mechanical Data TO-252

60V N-Channel MOSFET



Ref.	Dimensions					
	Millimeters			Inches		
	Min.	Typ.	Max.	Min.	Typ.	Max.
A	2.10		2.50	0.083		0.098
A2	0		0.10	0		0.004
B	0.66		0.86	0.026		0.034
B2	5.18		5.48	0.202		0.216
C	0.40		0.60	0.016		0.024
C2	0.44		0.58	0.017		0.023
D	5.90		6.30	0.232		0.248
D1	5.30REF			0.209REF		
E	6.40		6.80	0.252		0.268
E1	4.63			0.182		
G	4.47		4.67	0.176		0.184
H	9.50		10.70	0.374		0.421
L	1.09		1.21	0.043		0.048
L2	1.35		1.65	0.053		0.065
V1		7°			7°	
V2	0°		6°	0°		6°

Ordering information

Order code	Package	Baseqty	Delivery mode
UMW NTD20N06LT4G	TO-252	2500	Tape and reel