

General Description

The AO4485 uses advanced trench technology to provide excellent $R_{DS(ON)}$ with low gate charge. This device is suitable for use as a DC-DC converter application.

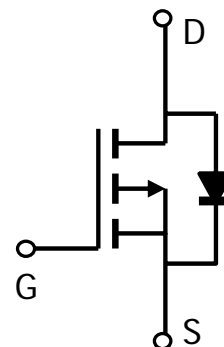

Features

- V_{DS} (V) = -40V
- I_D = -10A
- $R_{DS(ON)} < 15m\Omega$ ($V_{GS} = -10V$)
- $R_{DS(ON)} < 20m\Omega$ ($V_{GS} = -4.5V$)

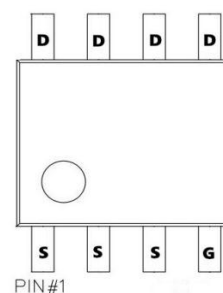

Absolute Maximum Ratings $T_J=25^\circ C$ unless otherwise noted

Parameter	Symbol	10 Sec	Steady State	Units
Drain-Source Voltage	V_{DS}	-40		V
Gate-Source Voltage	V_{GS}	± 20		V
Continuous Drain Current ^A	I_D	$T_A=25^\circ C$	-12	A
		$T_A=70^\circ C$	-9	
Pulsed Drain Current ^B	I_{DM}	-120		W
Avalanche Current ^G	I_{AR}	-28		
Repetitive avalanche energy $L=0.3mH$ ^G	E_{AR}	118		
Power Dissipation ^A	P_D	$T_A=25^\circ C$	3.1	1.7
		$T_A=70^\circ C$	2.0	1.1
Junction and Storage Temperature Range	T_J, T_{STG}	-55 to 150		$^\circ C$

Thermal Characteristics

Parameter	Symbol	Typ	Max	Units
Maximum Junction-to-Ambient ^A	$R_{\theta JA}$	31	40	$^\circ C/W$
Maximum Junction-to-Ambient ^A		Steady State	59	75
Maximum Junction-to-Lead ^C	$R_{\theta JL}$	16	24	$^\circ C/W$

Electrical Characteristics (T_J=25°C unless otherwise noted)

Symbol	Parameter	Conditions	Min	Typ	Max	Units
STATIC PARAMETERS						
BV _{DSS}	Drain-Source Breakdown Voltage	I _D = -250μA, V _{GS} = 0V	-40			V
I _{DSS}	Zero Gate Voltage Drain Current	V _{DS} = -40V, V _{GS} = 0V T _J = 55°C			-1 -5	μA
I _{GSS}	Gate-Body leakage current	V _{DS} = 0V, V _{GS} = ±20V			±100	nA
V _{GS(th)}	Gate Threshold Voltage	V _{DS} = V _{GS} , I _D = -250μA	-1	-1.5	-2.5	V
I _{D(ON)}	On state drain current	V _{GS} = -10V, V _{DS} = -5V	-120			A
R _{DS(ON)}	Static Drain-Source On-Resistance	V _{GS} = -10V, I _D = -10A V _{GS} = -4.5V, I _D = -8A		12.5 16	15 20	mΩ
g _{FS}	Forward Transconductance	V _{DS} = -5V, I _D = -10A		25		S
V _{SD}	Diode Forward Voltage	I _S = -1A, V _{GS} = 0V		-0.7	-1	V
I _S	Maximum Body-Diode Continuous Current				-3	A
DYNAMIC PARAMETERS						
C _{iss}	Input Capacitance	V _{GS} =0V, V _{DS} =-20V, f=1MHz		2500	3000	pF
C _{oss}	Output Capacitance			260		pF
C _{rss}	Reverse Transfer Capacitance			180		pF
R _g	Gate resistance	V _{GS} =0V, V _{DS} =0V, f=1MHz	2.5	4	6	Ω
SWITCHING PARAMETERS						
Q _g (10V)	Total Gate Charge	V _{GS} =-10V, V _{DS} =-20V, I _D =-10A		42	55	nC
Q _g (4.5V)	Total Gate Charge			18.6		nC
Q _{gs}	Gate Source Charge			7		nC
Q _{gd}	Gate Drain Charge			8.6		nC
t _{D(on)}	Turn-On DelayTime	V _{GS} =-10V, V _{DS} =-20V, R _L = 2Ω, R _{GEN} =3Ω		9.4		ns
t _r	Turn-On Rise Time			20		ns
t _{D(off)}	Turn-Off DelayTime			55		ns
t _f	Turn-Off Fall Time			30		ns
t _{rr}	Body Diode Reverse Recovery Time	I _F =-10A, dI/dt=100A/μs		38	49	ns
Q _{rr}	Body Diode Reverse Recovery Charge	I _F =-10A, dI/dt=100A/μs		47		nC

A: The value of R_{θJA} is measured with the device mounted on 1 in² FR-4 board with 2oz. Copper, in a still air environment with T_A = 25°C. The value in any given application depends on the user's specific board design.

B: Repetitive rating, pulse width limited by junction temperature.

C: The R_{θJA} is the sum of the thermal impedance from junction to lead R_{θJL} and lead to ambient.

D: The static characteristics in Figures 1 to 6 are obtained using t ≤ 300μs pulses, duty cycle 0.5% max.

E: These tests are performed with the device mounted on 1 in² FR-4 board with 2oz. Copper, in a still air environment with T_A=25°C. The SOA curve provides a single pulse rating.

F: The current rating is based on the t ≤ 10s thermal resistance rating.

G: E_{AR} and I_{AR} ratings are based on low frequency and duty cycles to keep T_J=25C.

TYPICAL ELECTRICAL AND THERMAL CHARACTERISTICS

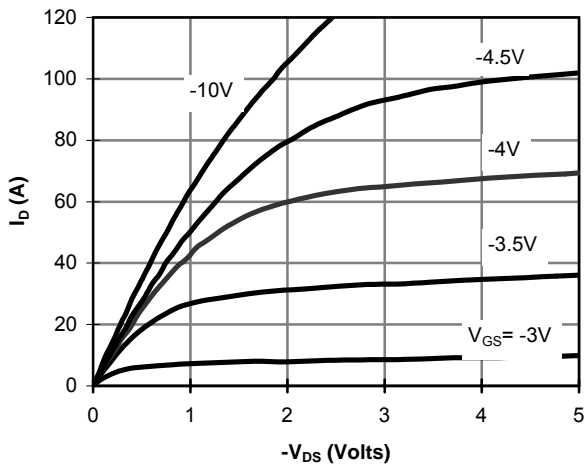

Figure 1: On-Region Characteristics

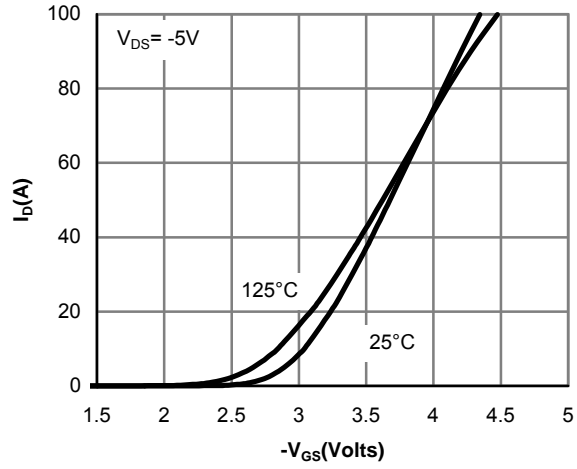

Figure 2: Transfer Characteristics

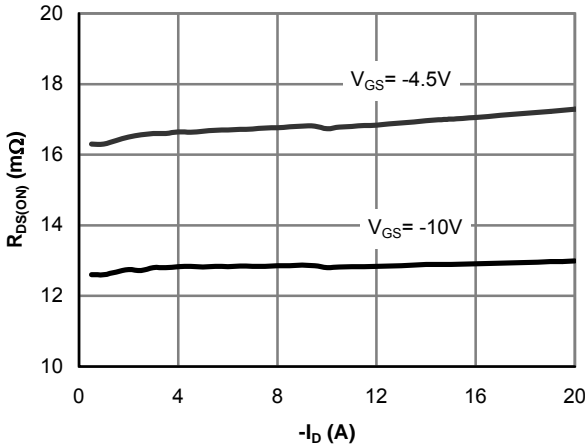

Figure 3: On-Resistance vs. Drain Current and Gate Voltage

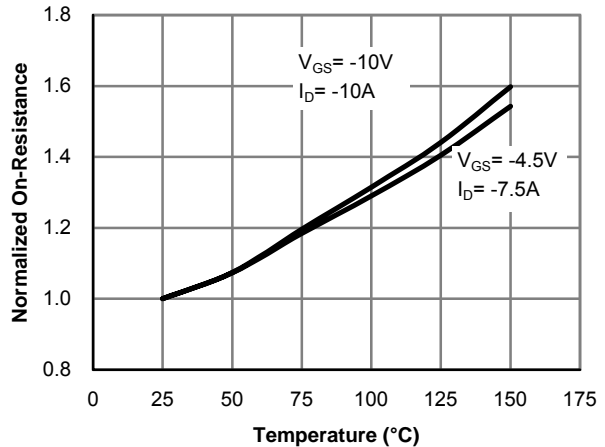

Figure 4: On-Resistance vs. Junction Temperature

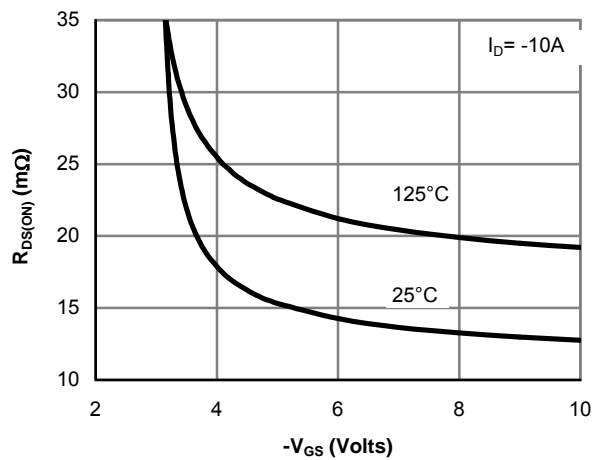

Figure 5: On-Resistance vs. Gate-Source Voltage

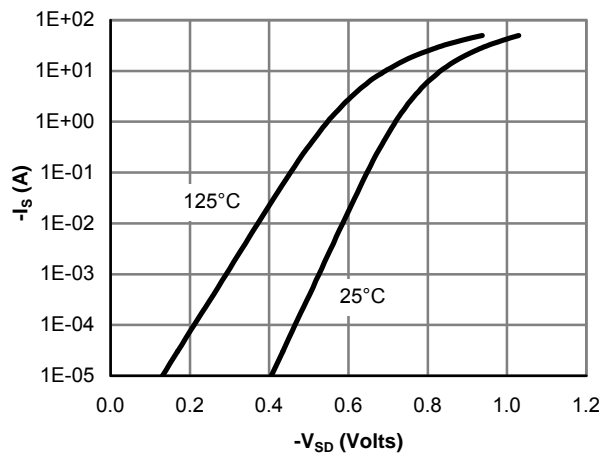

Figure 6: Body-Diode Characteristics

TYPICAL ELECTRICAL AND THERMAL CHARACTERISTICS

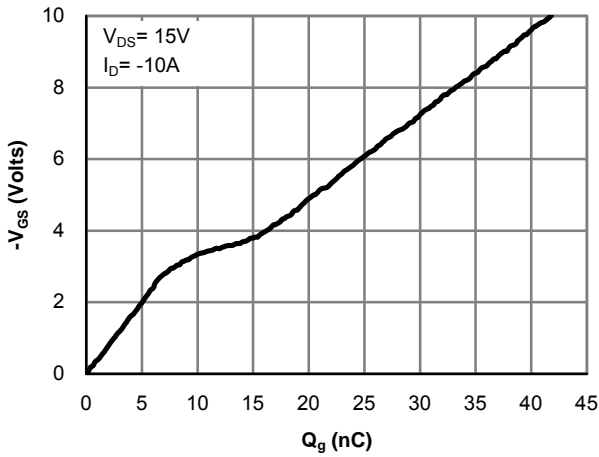

Figure 7: Gate-Charge Characteristics

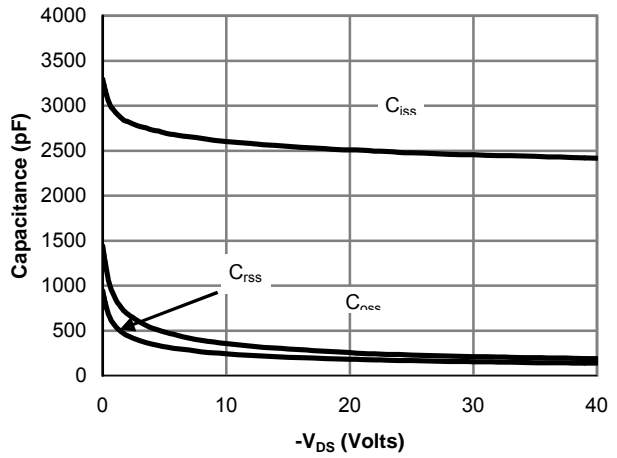

Figure 8: Capacitance Characteristics

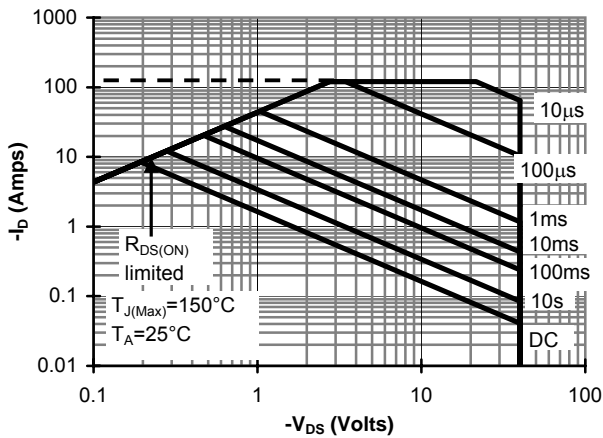

Figure 9: Maximum Forward Biased Safe Operating Area (Note E)

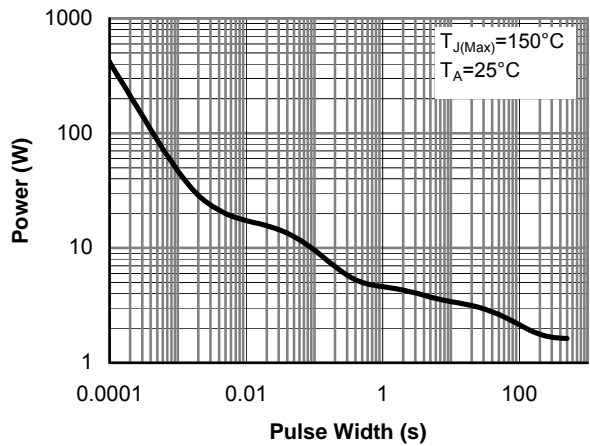

Figure 10: Single Pulse Power Rating Junction-to-Ambient (Note E)

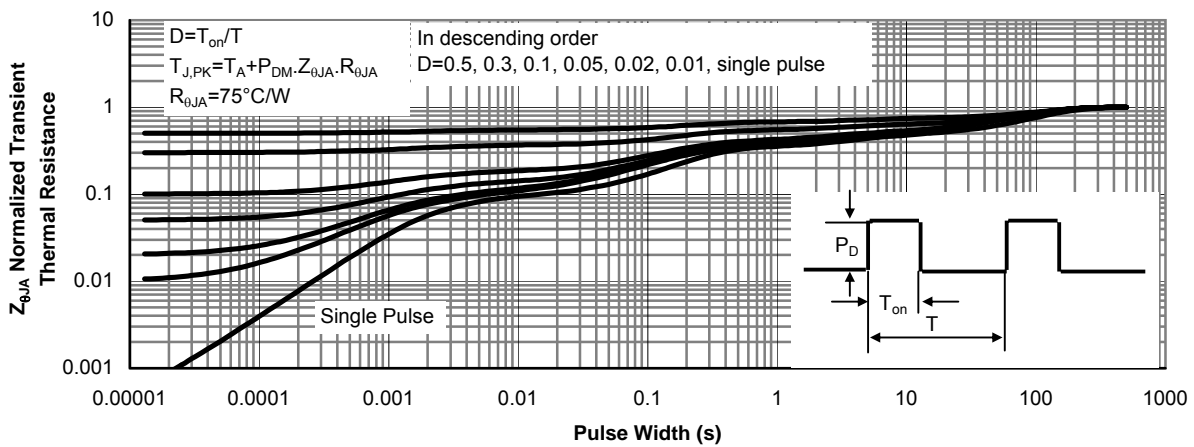
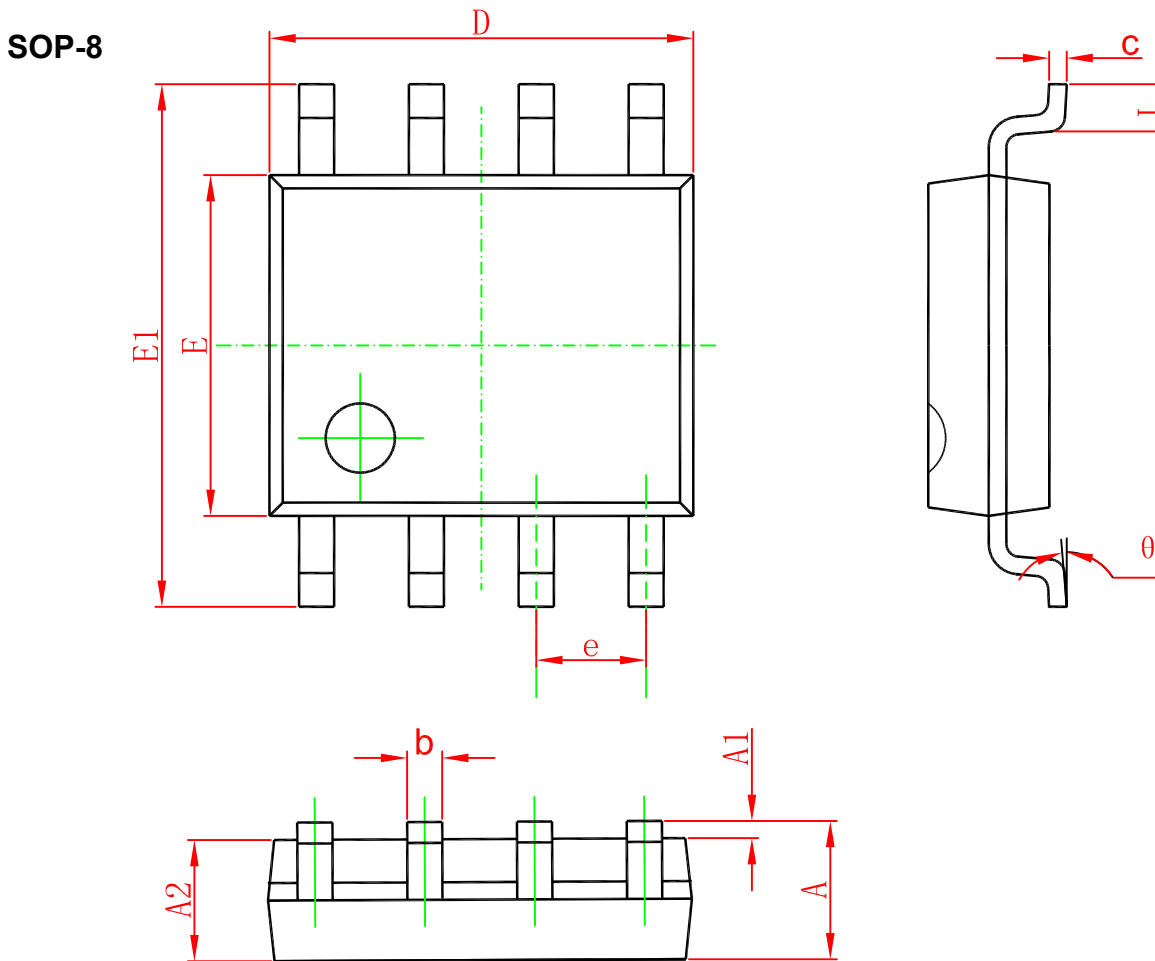

Figure 11: Normalized Maximum Transient Thermal Impedance (Note E)

PACKAGE OUTLINE DIMENSIONS



Symbol	Dimensions In Millimeters		Dimensions In Inches	
	Min	Max	Min	Max
A	1.350	1.750	0.053	0.069
A1	0.100	0.250	0.004	0.010
A2	1.350	1.550	0.053	0.061
b	0.330	0.510	0.013	0.020
c	0.170	0.250	0.006	0.010
D	4.700	5.100	0.185	0.200
E	3.800	4.000	0.150	0.157
E1	5.800	6.200	0.228	0.244
e	1.270(BSC)		0.050(BSC)	
L	0.400	1.270	0.016	0.050
θ	0°	8°	0°	8°

Marking

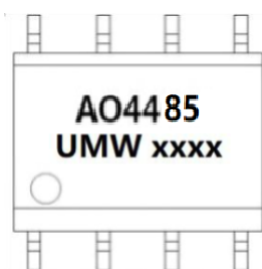

("xxxx"代表年份周期)

Ordering information

Order code	Package	Baseqty	Deliverymode
UMW AO4485	SOP-8	3000	Tape and reel