

■ Features

- $V_{DS}(V) = 30V$
- $R_{DS(ON)} < 35m\Omega$  ( $V_{GS} = -10V$ ),  $I_D = 4A$
- $R_{DS(ON)} < 50m\Omega$  ( $V_{GS} = -4.5V$ ),  $I_D = 3.5A$

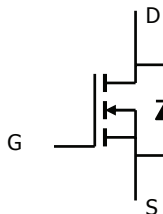
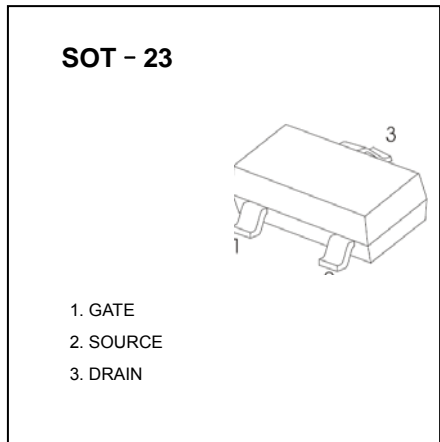

■ Absolute Maximum Ratings  $T_a = 25$

Parameter	Symbol	Rating	Unit	
Drain-Source Voltage	$V_{DS}$	30	V	
Gate-Source Voltage	$V_{GS}$	$\pm 20$		
Continuous Drain Current $T_j = 150^\circ C$ *1	$I_D$	$T_a = 25^\circ C$	4	A
		$T_a = 70^\circ C$	3.5	
Pulsed Drain Current	$I_{DM}$	16		
Power Dissipation *1	$P_D$	$T_a = 25^\circ C$	1.25	W
		$T_a = 70^\circ C$	0.8	
Thermal Resistance. Junction- to-Ambient	$R_{thJA}$	$t \leq 5$ sec	100	$^\circ C/W$
		Steady State	130	
Junction Temperature	$T_J$	150	$^\circ C$	
Storage Temperature Range	$T_{stg}$	-55 to 150		

\*1.Surface Mounted on FR4 Board,  $t \leq 5$  sec

**■ Electrical Characteristics Ta = 25°C**

Parameter	Symbol	Testconditions	Min	Typ	Max	Unit
Drain-source breakdown voltage	$V_{(BR)DSS}$	$V_{GS} = 0\text{ V}, I_D = 250\text{ }\mu\text{A}$	30			V
Gate threshold voltage	$V_{GS(th)}$	$V_{DS} = V_{GS}, I_D = 250\text{ }\mu\text{A}$	1		3	
Gate-body leakage	$I_{GSS}$	$V_{DS} = 0\text{ V}, V_{GS} = \pm 20\text{ V}$			$\pm 100$	nA
Zero gate voltage drain current	$I_{DSS}$	$V_{DS} = 30\text{ V}, V_{GS} = 0\text{ V}$			0.5	uA
		$V_{DS} = 30\text{ V}, V_{GS} = 0\text{ V}, T_J = 55\text{ }^\circ\text{C}$			10	
On-state drain current	$I_{D(on)}$	$V_{DS} \geq 4.5\text{ V}, V_{GS} = 10\text{ V}$	6			A
		$V_{DS} \geq 4.5\text{ V}, V_{GS} = 4.5\text{ V}$	4			
Drain-source on-state resistance	$r_{DS(on)}$	$V_{GS} = 10\text{ V}, I_D = 4\text{ A}$			35	mΩ
		$V_{GS} = 4.5\text{ V}, I_D = 3.5\text{ A}$			50	
Forward transconductance	$g_{fs}$	$V_{DS} = 4.5\text{ V}, I_D = 3.5\text{ A}$		6.9		S
Diode forward voltage	$V_{SD}$	$I_S = 1.25\text{ A}, V_{GS} = 0\text{ V}$		0.8	1.2	V
gate charge *	$Q_g$	$V_{DS} = 15\text{ V}, V_{GS} = 5\text{ V}, I_D = 3.5\text{ A}$		4.2	7	nC
Total gate charge *	$Q_{gt}$	$V_{DS} = 15\text{ V}, V_{GS} = 10\text{ V}, I_D = 3.5\text{ A}$		8.5	20	nC
Gate-source charge *	$Q_{gs}$			1.9		
Gate-drain charge *	$Q_{gd}$			1.35		
Gate Resistance	$R_g$		0.5		2.4	Ω
Input capacitance *	$C_{iss}$	$V_{DS} = 15\text{ V}, V_{GS} = 0, f = 1\text{ MHz}$		555		pF
Output capacitance *	$C_{oss}$			120		
Reverse transfer capacitance *	$C_{rss}$			60		
Turn-on time	$t_{d(on)}$	$V_{DD} = 15\text{ V}, R_L = 15\text{ }\Omega,$ $I_D = 1\text{ A}, V_{GEN} = -10\text{ V}, R_G = 6\text{ }\Omega$		9	20	ns
	$t_r$			7.5	18	
Turn-off time	$t_{d(off)}$			17	35	
	$t_f$			5.2	12	

\* Pulse test:  $PW \leq 300\text{ }\mu\text{s}$  duty cycle  $\leq 2\%$ .

■ Typical Characteristics

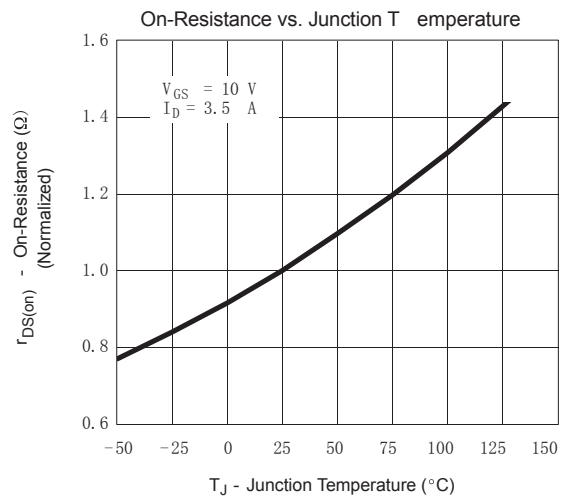
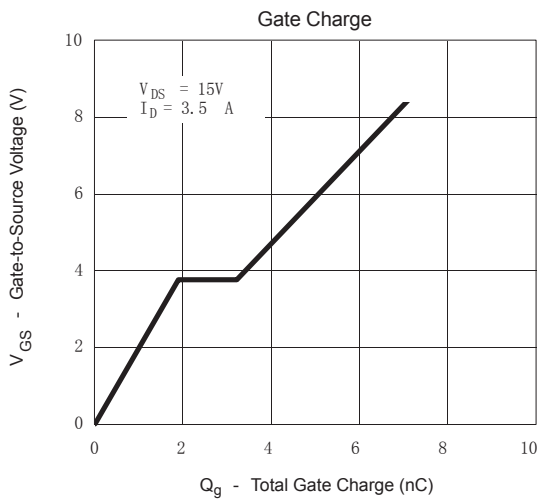
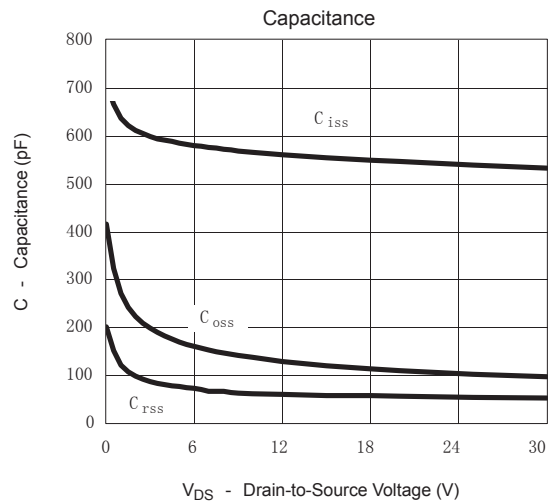
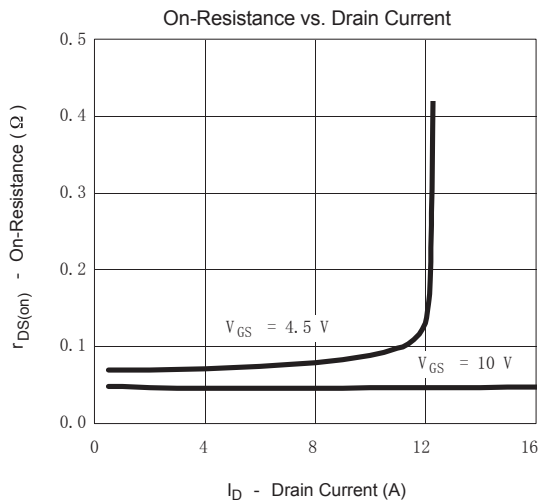
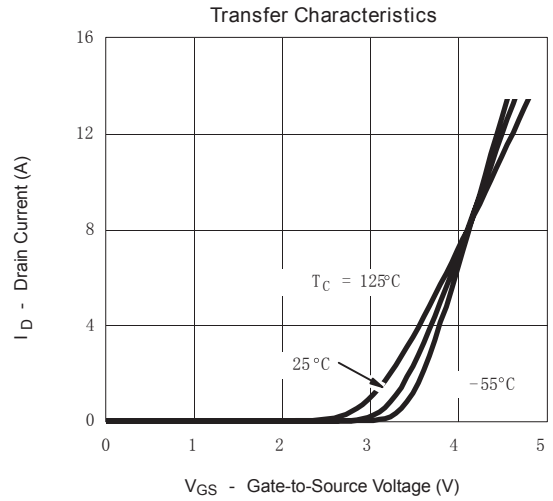
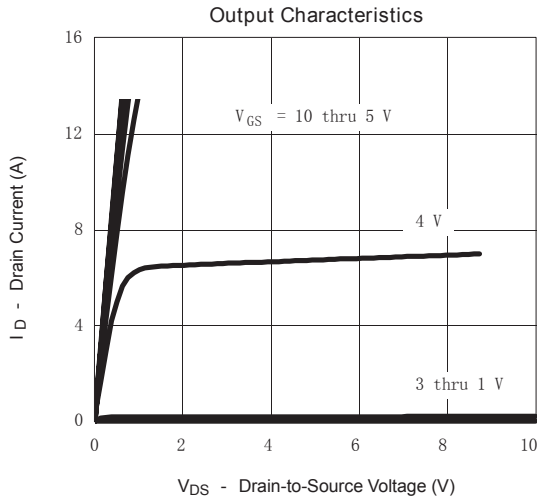

■ Typical Characteristics

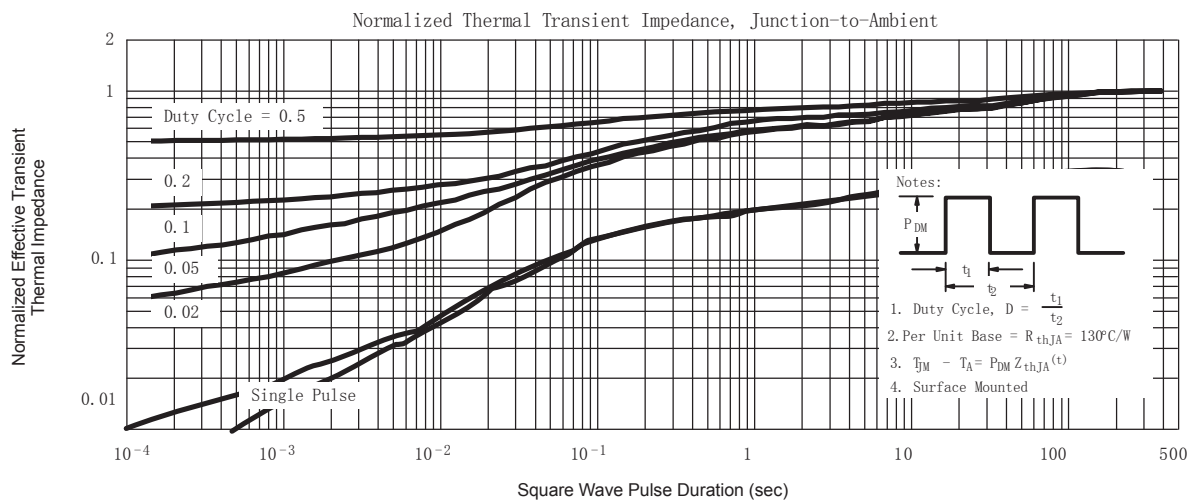
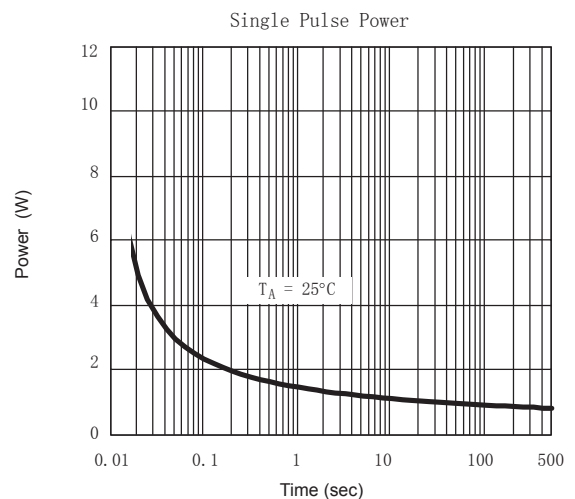
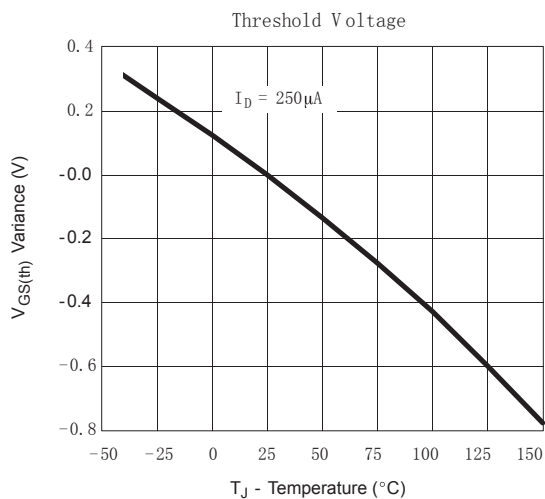
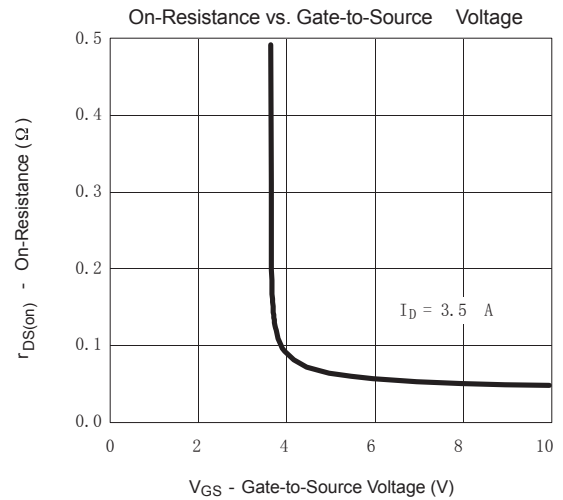
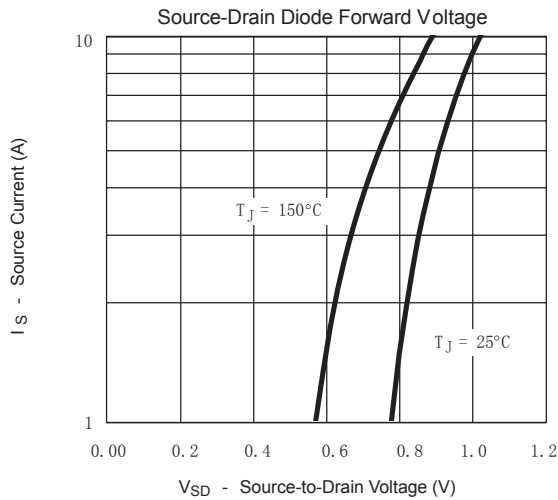

SOT-23 PACKAGE OUTLINE DIMENSIONS

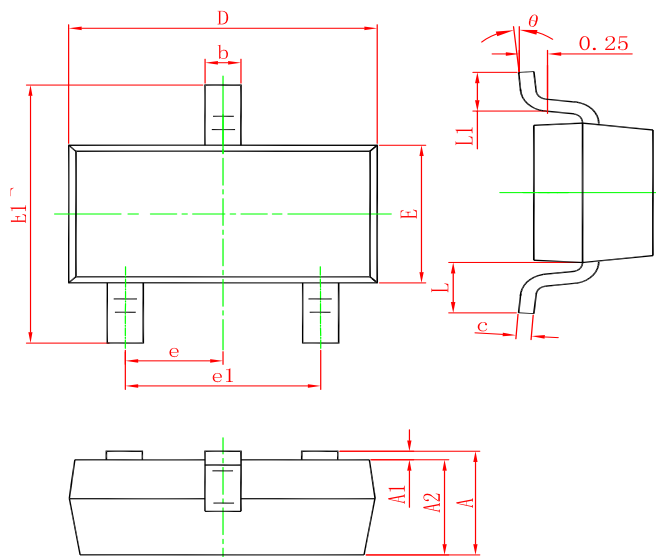

Symbol	Dimensions In Millimeters		Dimensions In Inches	
	Min.	Max.	Min.	Max.
A	0.900	1.150	0.035	0.045
A1	0.000	0.100	0.000	0.004
A2	0.900	1.050	0.035	0.041
b	0.300	0.500	0.012	0.020
c	0.080	0.150	0.003	0.006
D	2.800	3.000	0.110	0.118
E	1.200	1.400	0.047	0.055
E1	2.250	2.550	0.089	0.100
e	0.950 TYP.		0.037 TYP.	
e1	1.800	2.000	0.071	0.079
L	0.550 REF.		0.022 REF.	
L1	0.300	0.500	0.012	0.020
θ	0°	8°	0°	8°

Marking



Ordering information

Order code	Package	Baseqty	Deliverymode
UMW SI2306A	SOT-23	3000	Tape and reel