

■ Features

- $V_{DS(V)} = 20V$
- $I_D = 6 A (V_{GS} = 4.5V)$
- $R_{DS(ON)} < 25m\Omega (V_{GS} = 4.5V)$
- $R_{DS(ON)} < 33m\Omega (V_{GS} = 2.5V)$
- $R_{DS(ON)} < 51m\Omega (V_{GS} = 1.8V)$

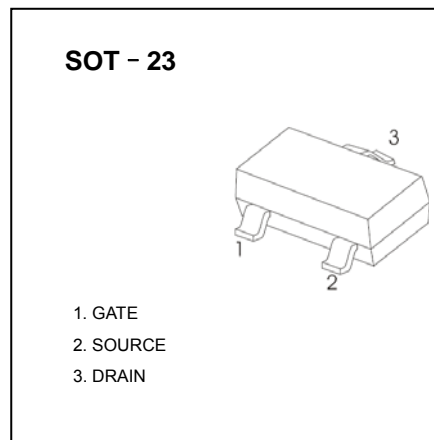
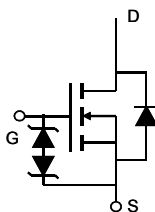

■ Absolute Maximum Ratings $T_a = 25^\circ C$

| Parameter | Symbol | Rating | Unit | |
|---|------------|------------------|------------|--------------|
| Drain-Source Voltage | V_{DS} | 20 | V | |
| Gate-Source Voltage | V_{GS} | ± 8 | | |
| Continuous Drain Current | I_D | $T_a=25^\circ C$ | 6 | A |
| | | $T_a=70^\circ C$ | 5 | |
| Pulsed Drain Current | I_{DM} | 30 | | |
| Power Dissipation | P_D | $T_a=25^\circ C$ | 1.4 | W |
| | | $T_a=70^\circ C$ | 0.9 | |
| Thermal Resistance..Junction- to-Ambient $t \leq 10sec$ Steady State | R_{thJA} | | 90 | $^\circ C/W$ |
| | | | 125 | |
| Thermal Resistance..Junction-to-Foot | R_{thJF} | 80 | | |
| Junction Temperature | T_J | 150 | $^\circ C$ | |
| Storage Temperature Range | T_{stg} | -55 to 150 | | |

■ Electrical Characteristics Ta = 25°C

| Parameter | Symbol | Test Conditions | Min | Typ | Max | Unit |
|---------------------------------------|---------------------|---|-----|------|------|------|
| Drain-Source Breakdown Voltage | V _{DSS} | I _D =250μA, V _{GS} =0V | 20 | | | V |
| Zero Gate Voltage Drain Current | I _{DSS} | V _{DS} =20V, V _{GS} =0V | | | 1 | μA |
| | | V _{DS} =20V, V _{GS} =0V, Ta=70°C | | | 5 | |
| Gate-Body Leakage Current | I _{GSS} | V _{DS} =0V, V _{GS} =±8V | | | ±10 | μA |
| Gate Threshold Voltage | V _{GS(th)} | V _{DS} =V _{GS} , I _D =250 μ A | 0.4 | | 1.1 | V |
| On-State Drain Current | I _{D(on)} | V _{DS} =5 V, V _{GS} = 4.5 V | 30 | | | A |
| Static Drain-Source On-Resistance | R _{DS(on)} | V _{GS} =4.5V, I _D =6.5A | | | 25 | mΩ |
| | | V _{GS} =2.5V, I _D =5.5A | | | 33 | |
| | | V _{GS} =1.8V, I _D =5A | | | 51 | |
| Forward Transconductance | g _{FS} | V _{DS} =5V, I _D =6.5A | | 50 | | S |
| Input Capacitance | C _{iss} | V _{GS} =0V, V _{DS} =10V, f=1MHz | | 1295 | 1650 | pF |
| Output Capacitance | C _{oss} | | | 160 | | |
| Reverse Transfer Capacitance | C _{rss} | | | 87 | | |
| Gate Resistance | R _g | V _{GS} =0V, V _{DS} =0V, f=1MHz | | 1.8 | | KΩ |
| Total Gate Charge | Q _g | V _{GS} =4.5V, V _{DS} =10V, I _D =6.5A | | 10 | | nC |
| Gate Source Charge | Q _{gs} | | | 4.2 | | |
| Gate Drain Charge | Q _{gd} | | | 2.6 | | |
| Turn-On DelayTime | t _{d(on)} | V _{DS} =10V, V _{GEN} =4.5V R _L =1.54Ω, R _G =3Ω | | 280 | | ns |
| Turn-On Rise Time | t _r | | | 328 | | |
| Turn-Off DelayTime | t _{d(off)} | | | 3.76 | | |
| Turn-Off Fall Time | t _f | | | 2.24 | | |
| Body Diode Reverse Recovery Time | t _{rr} | | | 31 | 41 | |
| Body Diode Reverse Recovery Charg | Q _{rr} | I _F = 6.5A, di/dt= 100A/ μ s | | 6.8 | | nC |
| Maximum Body-Diode Continuous Current | I _S | | | | 2 | A |
| Diode Forward Voltage | V _{SD} | I _S =1.0A, V _{GS} =0V | | 0.62 | 1 | V |

*1 Pulse test: PW ≤ 300us duty cycle ≤ 2%.

■ Typical Characteristics

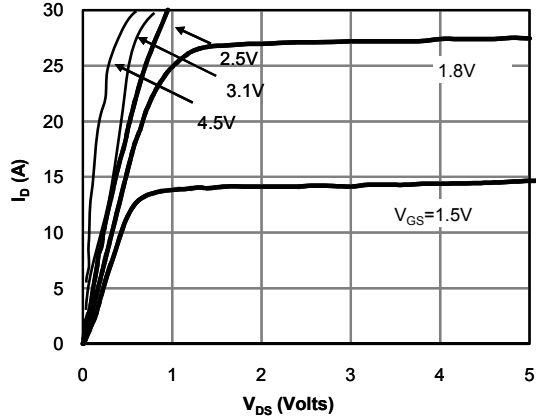

Fig 1: On-Region Characteristics (Note E)

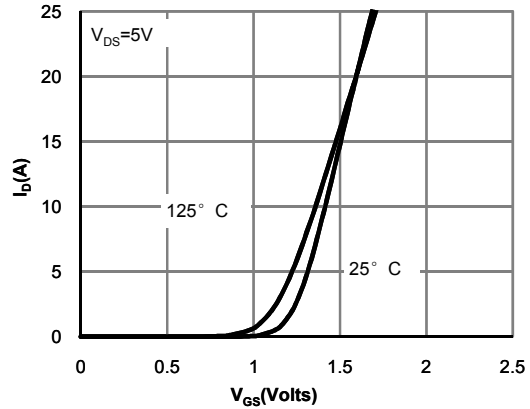

Figure 2: Transfer Characteristics (Note E)

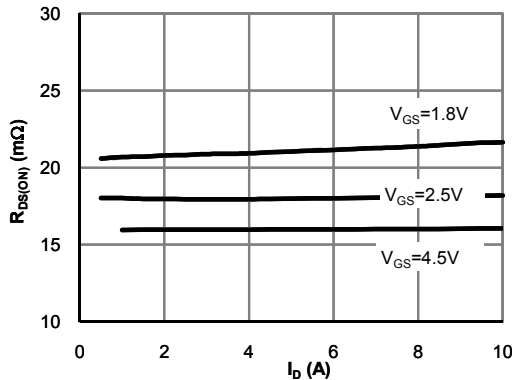

Figure 3: On-Resistance vs. Drain Current and Gate Voltage (Note E)

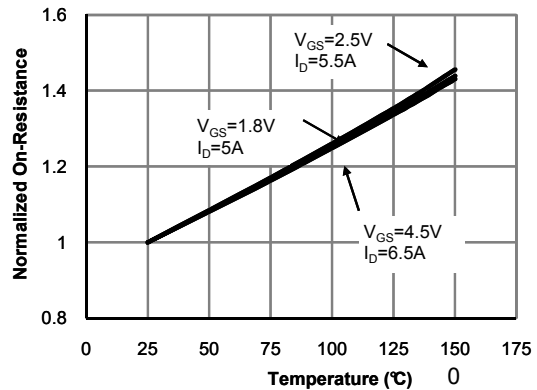

Figure 4: On-Resistance vs. Junction Temperature (Note E)

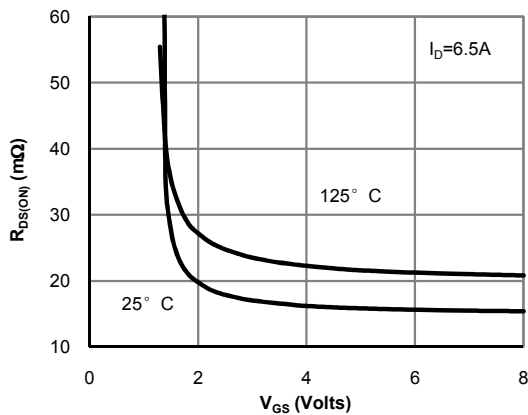

Figure 5: On-Resistance vs. Gate-Source Voltage (Note E)

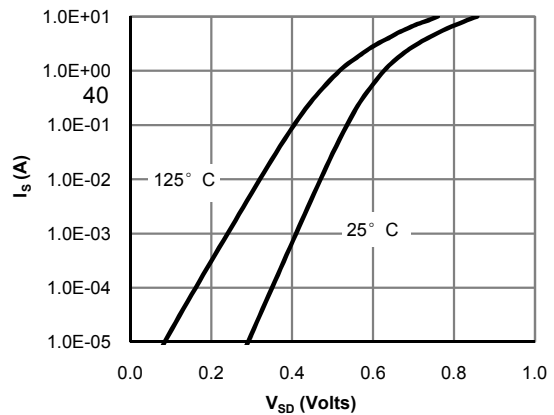

Figure 6: Body-Diode Characteristics (Note E)

■ Typical Characteristics

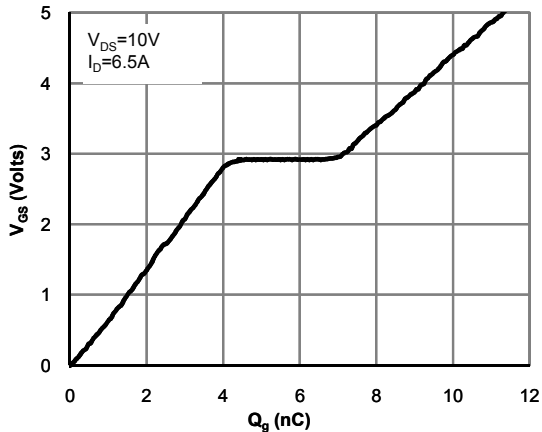

Figure 7: Gate-Charge Characteristics

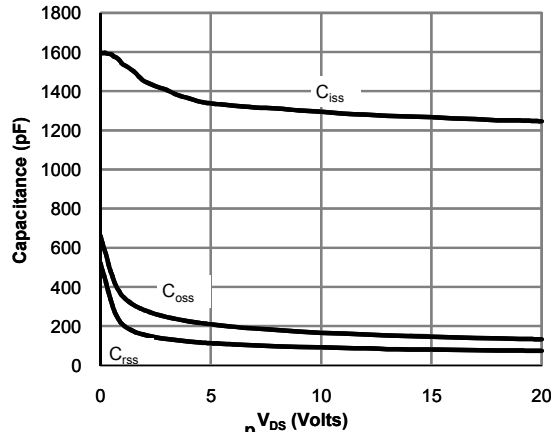

Figure 8: Capacitance Characteristics

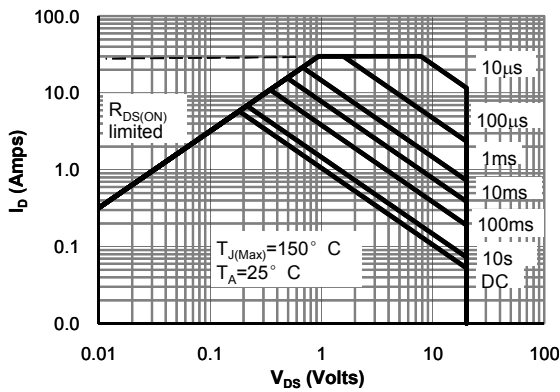

Figure 9: Maximum Forward Biased Safe Operating Area (Note F)

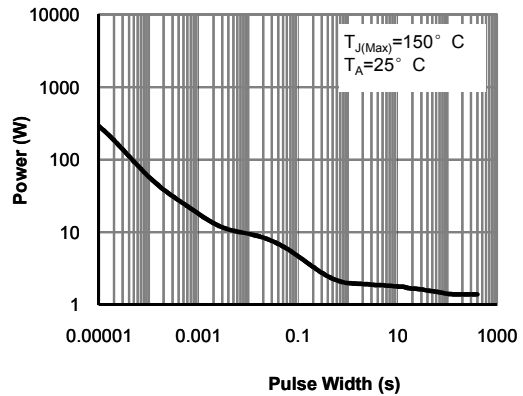

Figure 10: Single Pulse Power Rating Junction-to-Ambient (Note F)

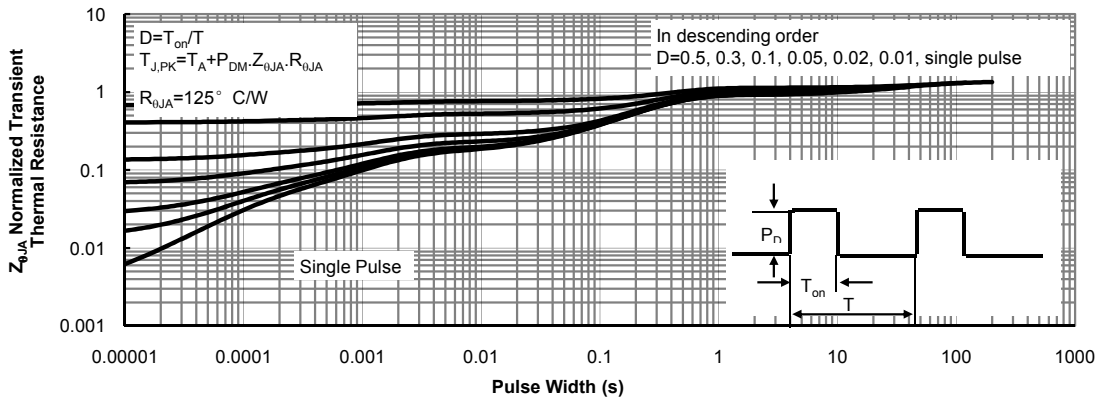
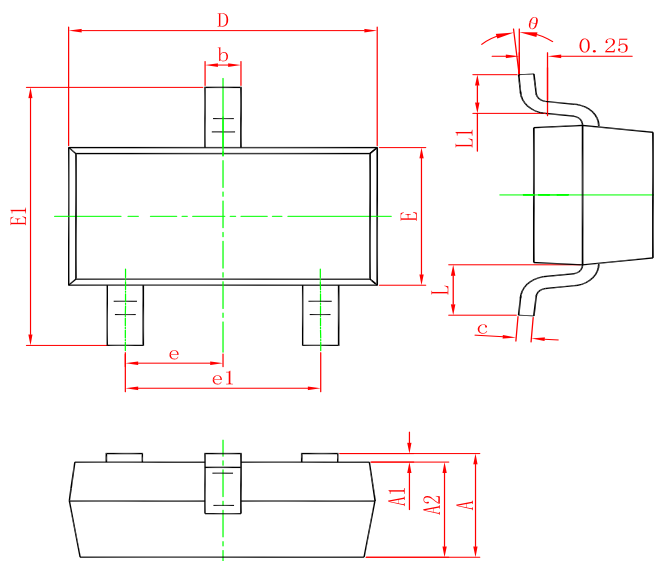

Figure 11: Normalized Maximum Transient Thermal Impedance (Note F)

SOT-23 PACKAGE OUTLINE DIMENSIONS



| Symbol | Dimensions In Millimeters | | Dimensions In Inches | |
|--------|---------------------------|-------|----------------------|-------|
| | Min. | Max. | Min. | Max. |
| A | 0.900 | 1.150 | 0.035 | 0.045 |
| A1 | 0.000 | 0.100 | 0.000 | 0.004 |
| A2 | 0.900 | 1.050 | 0.035 | 0.041 |
| b | 0.300 | 0.500 | 0.012 | 0.020 |
| c | 0.080 | 0.150 | 0.003 | 0.006 |
| D | 2.800 | 3.000 | 0.110 | 0.118 |
| E | 1.200 | 1.400 | 0.047 | 0.055 |
| E1 | 2.250 | 2.550 | 0.089 | 0.100 |
| e | 0.950 TYP. | | 0.037 TYP. | |
| e1 | 1.800 | 2.000 | 0.071 | 0.079 |
| L | 0.550 REF. | | 0.022 REF. | |
| L1 | 0.300 | 0.500 | 0.012 | 0.020 |
| θ | 0° | 8° | 0° | 8° |

Marking

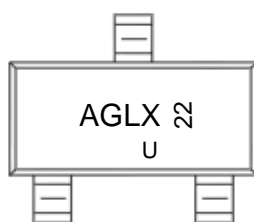

Ordering information

| Order code | Package | Baseqty | Deliverymode |
|-------------|---------|---------|---------------|
| UMW AO3416A | SOT-23 | 3000 | Tape and reel |