

■ Features

- $V_{DS} (V) = 30V$
- $I_D = 5.8 A (V_{GS} = 10V)$
- $R_{DS(ON)} < 25 m\Omega (V_{GS} = 10V)$
- $R_{DS(ON)} < 36 m\Omega (V_{GS} = 4.5V)$

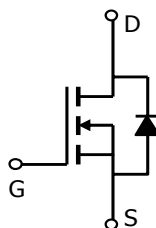
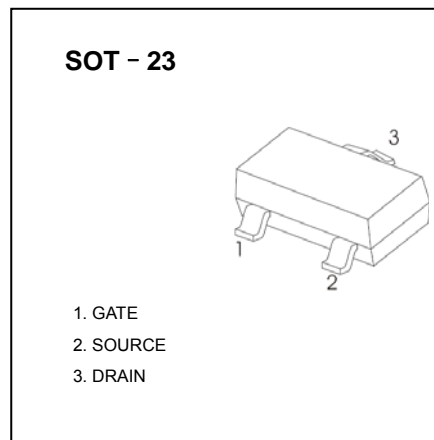

■ Absolute Maximum Ratings $T_a = 25^\circ C$

Parameter	Symbol	Rating	Unit
Drain-Source Voltage	V_{DS}	30	V
Gate-Source Voltage	V_{GS}	± 20	
Continuous Drain Current	I_D	$T_a = 25^\circ C$	A
		$T_a = 100^\circ C$	
Pulsed Drain Current	I_{DM}	20	4.9
Power Dissipation	P_D	$T_a = 25^\circ C$	W
		$T_a = 70^\circ C$	
Thermal Resistance.Junction- to-Ambient	R_{thJA}	$t \leq 5sec$	$^\circ C/W$
		Steady State	
Thermal Resistance.Junction- to-Lead	R_{thJL}	60	125
Junction Temperature	T_J	150	$^\circ C$
Storage Temperature Range	T_{stg}	-55 to 150	

N-Channel Enhancement MOSFET
■ Electrical Characteristics Ta = 25°C

Parameter	Symbol	Testconditions	Min	Typ	Max	Unit
Drain-Source Breakdown Voltage	V _{DSS}	I _D =250 μ A, V _{GS} =0V	30			V
Zero Gate Voltage Drain Current	I _{DSS}	V _{DS} =24V, V _{GS} =0V			1	μ A
		V _{DS} =24V, V _{GS} =0V, T _J =55°C			5	
Gate-Body leakage current	I _{GSS}	V _{DS} =0V, V _{GS} =±20V			100	nA
Gate Threshold Voltage	V _{GS(th)}	V _{DS} =V _{GS} I _D =250 μ A	1	1.9	3	V
On state drain current	I _{D(ON)}	V _{GS} =4.5V, V _{DS} =5V	20			A
Static Drain-Source On-Resistance	R _{DS(ON)}	V _{GS} =10V, I _D =5.8A			25	mΩ
		V _{GS} =4.5V, I _D =5.0A			36	
Forward Transconductance	g _{FS}	V _{DS} =5V, I _D =5.8A	10			S
Diode Forward Voltage	V _{SD}	I _S =1A		0.76	1	V
Maximum Body-Diode Continuous Current	I _S				2.5	A
Reverse Transfer Capacitance	C _{iss}	V _{GS} =0V, V _{DS} =15V, f=1MHz		680	820	pF
Gate resistance	C _{oss}			102		pF
Input Capacitance	C _{rss}			77		pF
Output Capacitance	R _g	V _{GS} =0V, V _{DS} =0V, f=1MHz		3	3.6	Ω
Total Gate Charge (10V)	Q _g	V _{GS} =10V, V _{DS} =15V, I _D =5.8A		13.88	17	nC
Total Gate Charge (4.5V)	Q _g			6.78	8.1	nC
Gate Source Charge	Q _{gs}			1.8		nC
Gate Drain Charge	Q _{gd}			3.12		nC
Turn-On Rise Time	t _{D(on)}		V _{GS} =10V, V _{DS} =15V, R _L =2.7 Ω, R _{GEN} =3 Ω		4.6	6.5
Turn-Off DelayTime	t _r			3.8	5.7	ns
Turn-Off Fall Time	t _{D(off)}			20.9	30	ns
Turn-On DelayTime	t _f			5	7.5	ns
Body Diode Reverse Recovery Time	t _{rr}	I _F =5.8A, di/dt=100A/μ s		16.1	21	ns
Body Diode Reverse Recovery Charge	Q _{rr}	I _F =5.8A, di/dt=100A/μ s		7.4	10	nC

■ Typical Characteristics

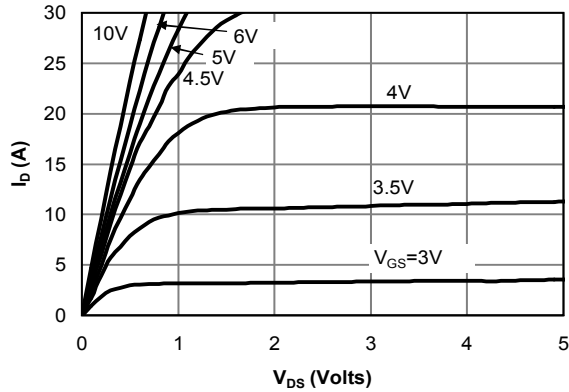

Fig 1: On-Region Characteristics

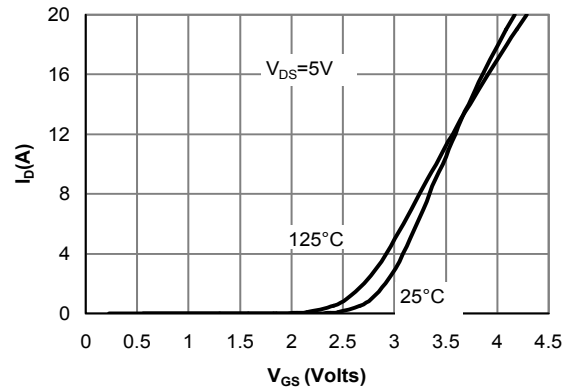

Figure 2: Transfer Characteristics

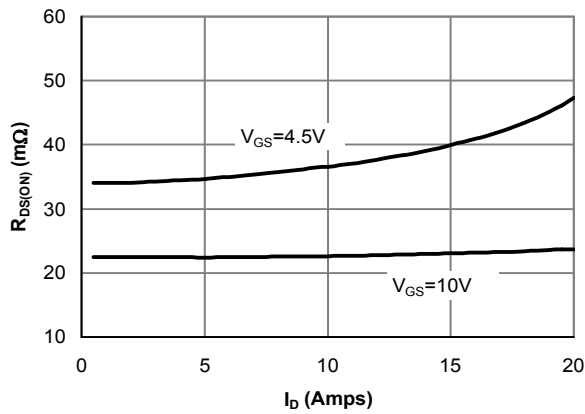

Figure 3: On-Resistance vs. Drain Current and Gate Voltage

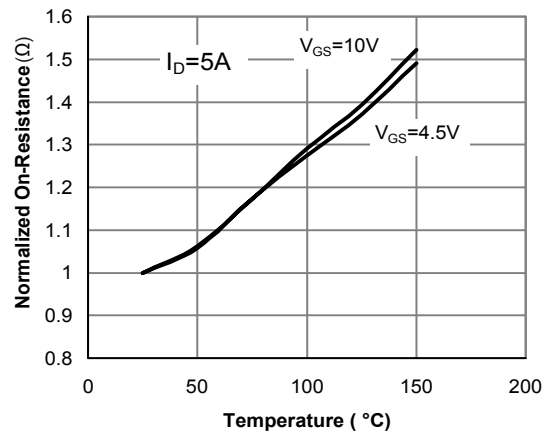

Figure 4: On-Resistance vs. Junction Temperature

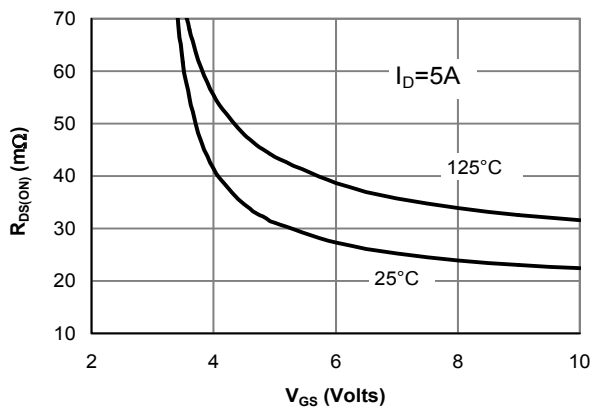

Figure 5: On-Resistance vs. Gate-Source Voltage

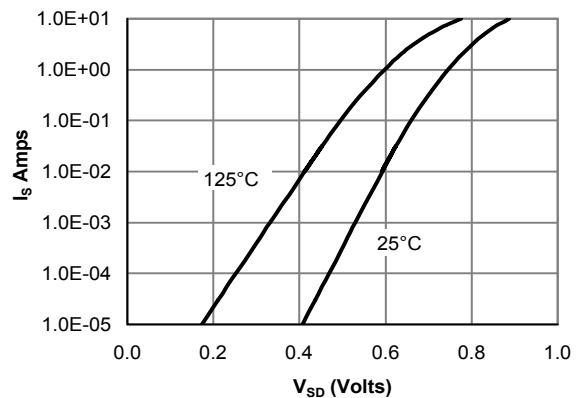

Figure 6: Body diode characteristics

■ Typical Characteristics

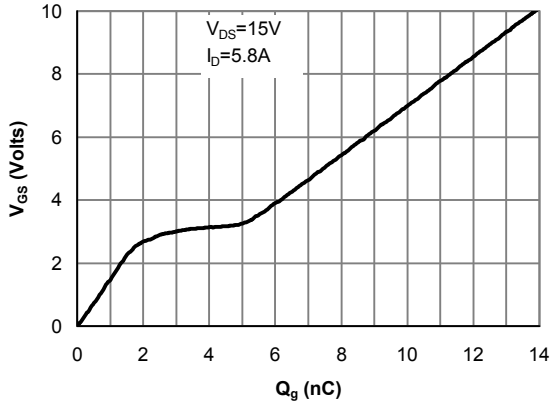

Figure 7: Gate-Charge characteristics

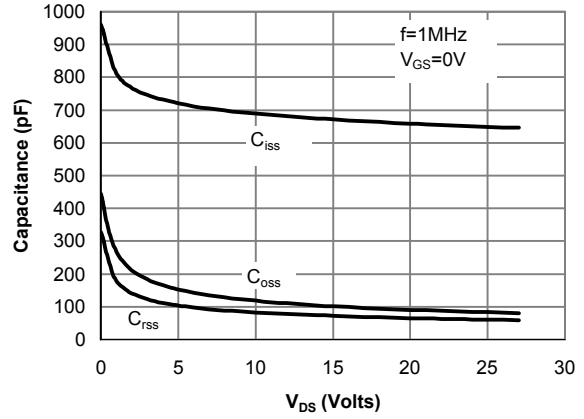

Figure 8: Capacitance Characteristics

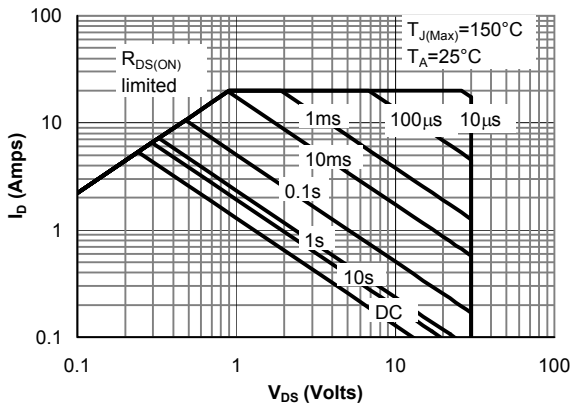

Figure 9: Maximum Forward Biased Safe Operating Area (Note E)

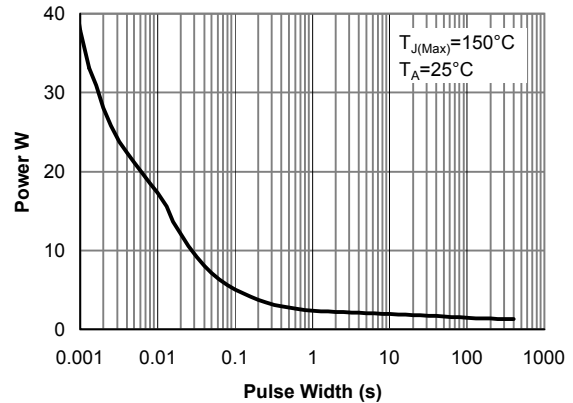

Figure 10: Single Pulse Power Rating Junction-to-Ambient (Note E)

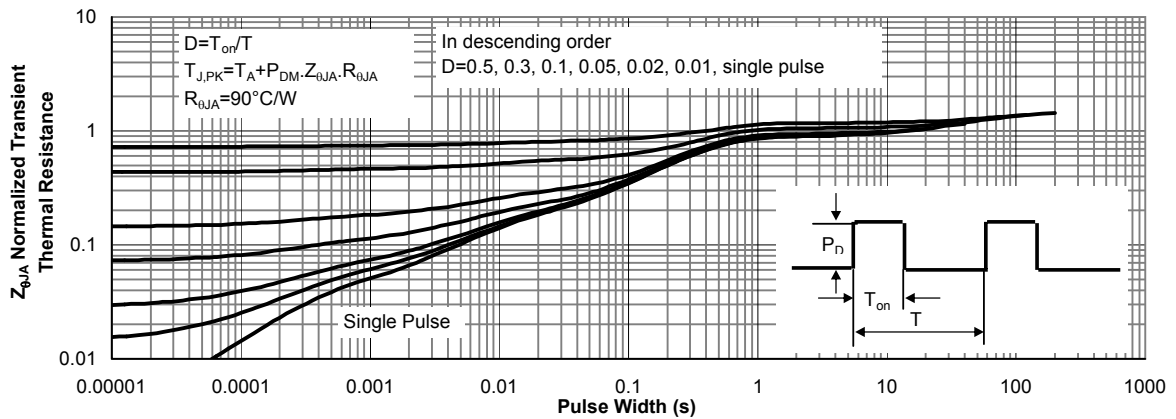
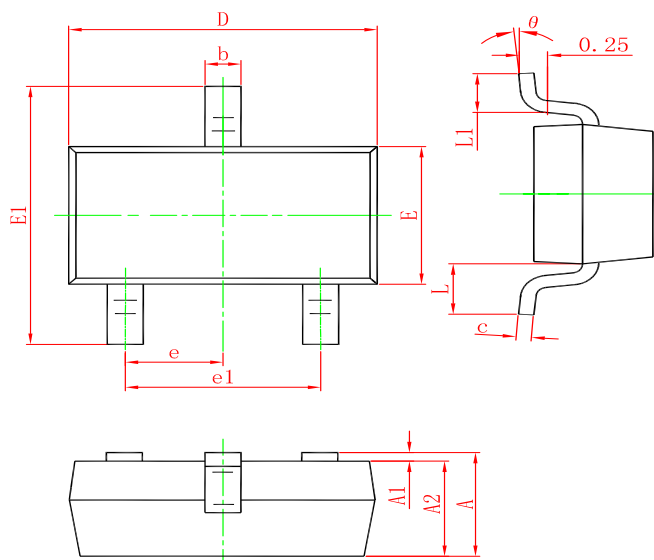

Figure 11: Normalized Maximum Transient Thermal Impedance

SOT-23 PACKAGE OUTLINE DIMENSIONS



Symbol	Dimensions In Millimeters		Dimensions In Inches	
	Min.	Max.	Min.	Max.
A	0.900	1.150	0.035	0.045
A1	0.000	0.100	0.000	0.004
A2	0.900	1.050	0.035	0.041
b	0.300	0.500	0.012	0.020
c	0.080	0.150	0.003	0.006
D	2.800	3.000	0.110	0.118
E	1.200	1.400	0.047	0.055
E1	2.250	2.550	0.089	0.100
e	0.950 TYP.		0.037 TYP.	
e1	1.800	2.000	0.071	0.079
L	0.550 REF.		0.022 REF.	
L1	0.300	0.500	0.012	0.020
θ	0°	8°	0°	8°

Marking

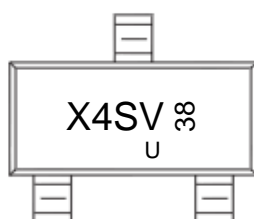

Ordering information

Order code	Package	Baseqty	Deliverymode
UMW AO3404A	SOT-23	3000	Tape and reel