

UMW AO3402A N-Channel MOSFET

$V_{(BR)DSS}$	$R_{DS(on)MAX}$	I_D
30V	52 mΩ @10V	4A
	65 mΩ @4.5V	
	85 mΩ @2.5V	

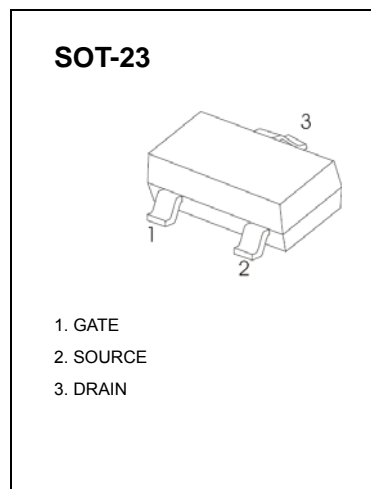

DESCRIPTION

The 3402 uses advanced trench technology to provide excellent $R_{DS(ON)}$, low gate charge and operation with gate voltage as low as 2.5V. This device is suitable for use as a load switch or in PWM application.

FEATURES

- Lead free product is acquired
- Surface mount package

APPLICATION

- Load Switch and in PWM applications

Equivalent Circuit

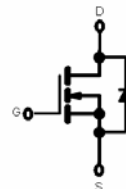

Maximum ratings ($T_a=25^{\circ}C$ unless otherwise noted)

Parameter	Symbol	Value	Unit
Drain-Source Voltage	V_{DS}	30	V
Gate-Source Voltage	V_{GS}	±12	V
Continuous Drain Current	I_D	4	A
Pulsed Drain Current (note 1)	I_{DM}	15	A
Power Dissipation	P_D	0.35	W
Thermal Resistance from Junction to Ambient (note 2)	$R_{\theta JA}$	357	$^{\circ}C/W$
Junction Temperature	T_J	150	$^{\circ}C$
Storage Temperature	T_{STG}	-55~+150	$^{\circ}C$

T_a=25 °C unless otherwise specified

Parameter	Symbol	Test Condition	Min	Typ	Max	Unit
STATIC CHARACTERISTICS						
Drain-source breakdown voltage	V _{(BR)DSS}	V _{GS} = 0V, I _D =250μA	30			V
Zero gate voltage drain current	I _{DSS}	V _{DS} =24V, V _{GS} = 0V			1	μA
Gate-body leakage current	I _{GSS}	V _{GS} =±12V, V _{DS} = 0V			100	nA
Gate threshold voltage (note 3)	V _{GS(th)}	V _{DS} =V _{GS} , I _D =250μA	0.8		1.4	V
Drain-source on-resistance (note 3)	R _{DS(on)}	V _{GS} =10V, I _D =4A			52	mΩ
		V _{GS} =4.5V, I _D =3A			65	mΩ
		V _{GS} =2.5V, I _D =2A			85	mΩ
Forward transconductance (note 3)	g _{FS}	V _{DS} =15V, I _D =4A		8		S
Diode forward voltage (note 3)	V _{SD}	I _S =1A, V _{GS} = 0V			1	V
DYNAMIC CHARACTERISTICS (note 4)						
Input capacitance	C _{iss}	V _{DS} =15V, V _{GS} =0V, f =1MHz		390		pF
Output capacitance	C _{oss}			54.5		pF
Reverse transfer capacitance	C _{rss}			41		Pf
Gate resistance	R _g	V _{DS} =0V, V _{GS} =0V, f =1MHz		3		Ω
SWITCHING CHARACTERISTICS (note 4)						
Turn-on delay time	t _{d(on)}	V _{GS} =10V, V _{DS} =15V, R _L =3.75Ω, R _{GEN} =6Ω		3.3		ns
Turn-on rise time	t _r			1		ns
Turn-off delay time	t _{d(off)}			21.7		ns
Turn-off fall time	t _f			2.1		ns
Total gate charge	Q _g	V _{DS} =15V, V _{GS} =4.5V, I _D =4A		4.34		nC
Gate-source Charge	Q _{gs}			0.6		nC
Gate-drain Charge	Q _{gd}			1.38		nC
Body diode reverse recovery time	t _r	I _F =4A, di/dt=100A/μs		1.2		ns
Body diode reverse recovery charge	Q _{rr}			6.3		nC

Notes :

1. Repetitive rating : Pulse width limited by junction temperature.
2. Surface mounted on FR4 board , t_s≤10s.
3. Pulse Test : Pulse Width≤80μs, Duty Cycle≤0.5%.
4. Guaranteed by design, not subject to producing.

■ Typical Characteristics

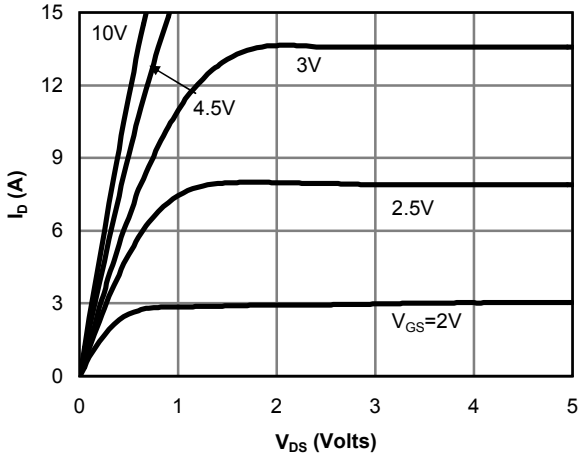

Fig 1: On-Region Characteristics

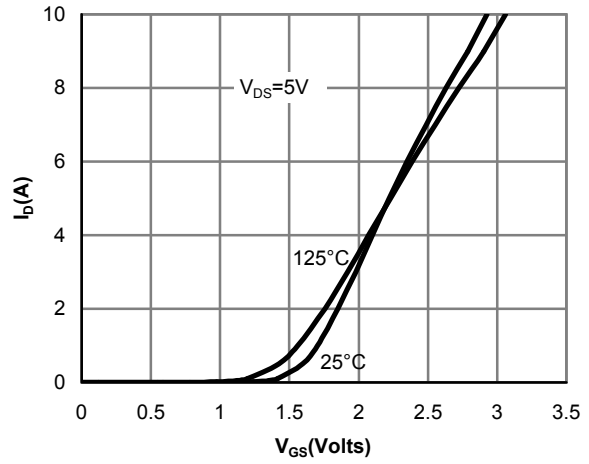

Figure 2: Transfer Characteristics

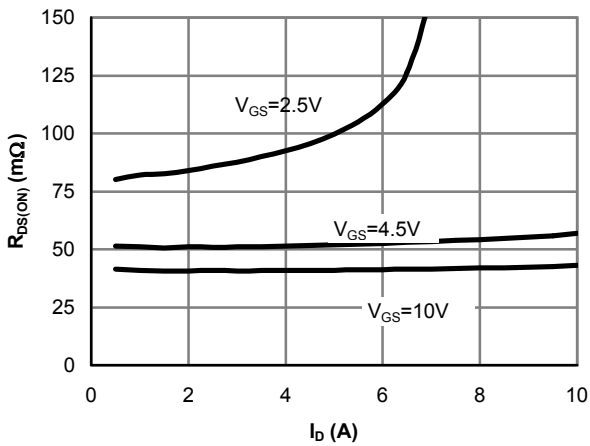

Figure 3: On-Resistance vs. Drain Current and Gate Voltage

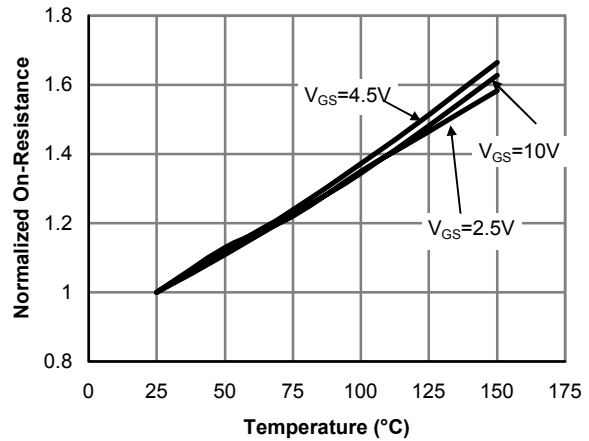

Figure 4: On-Resistance vs. Junction Temperature

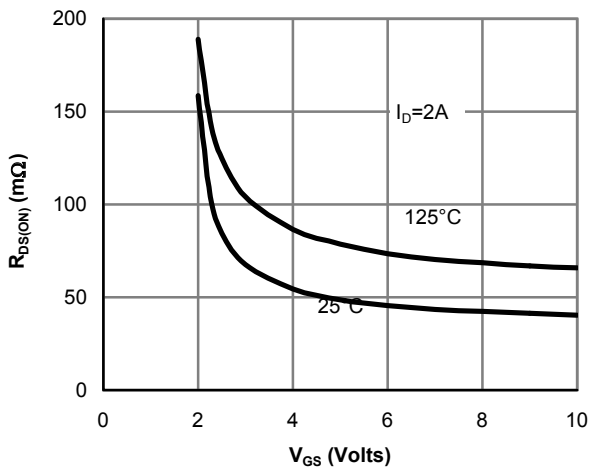

Figure 5: On-Resistance vs. Gate-Source Voltage

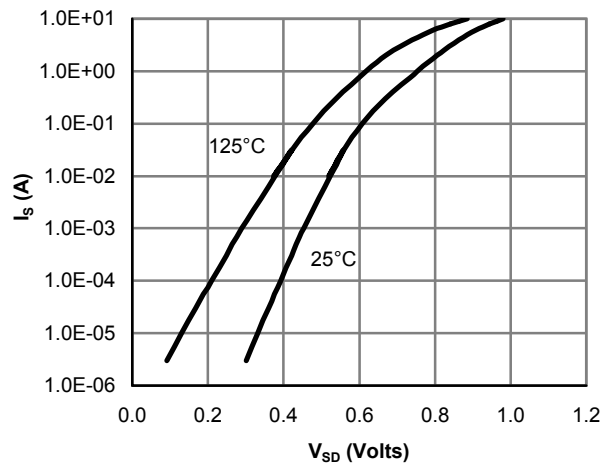

Figure 6: Body-Diode Characteristics

■ Typical Characteristics

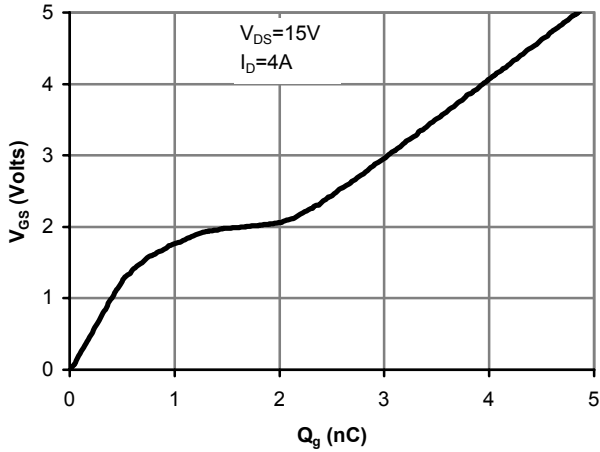

Figure 7: Gate-Charge Characteristics

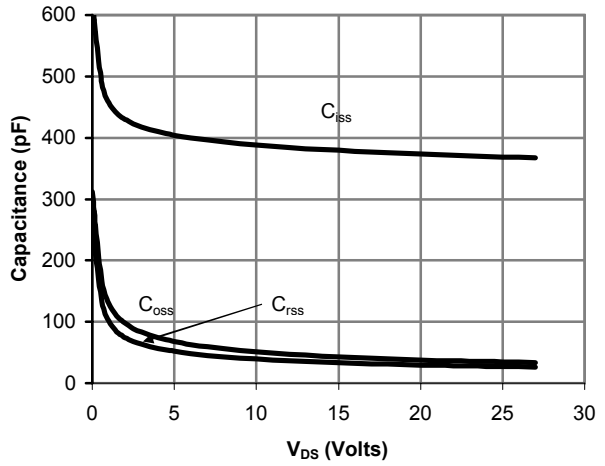

Figure 8: Capacitance Characteristics

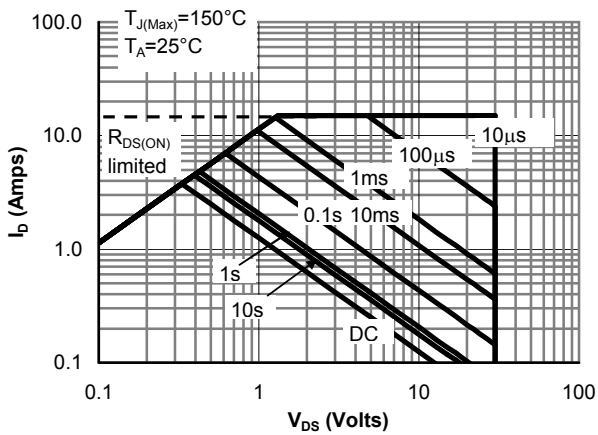

Figure 9: Maximum Forward Biased Safe Operating Area (Note E)

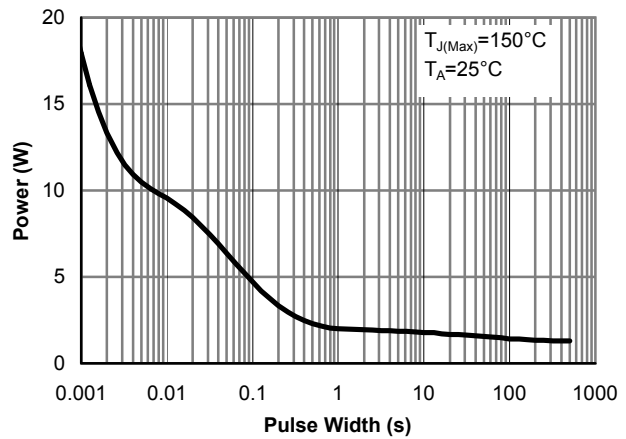

Figure 10: Single Pulse Power Rating Junction-to-Ambient (Note E)

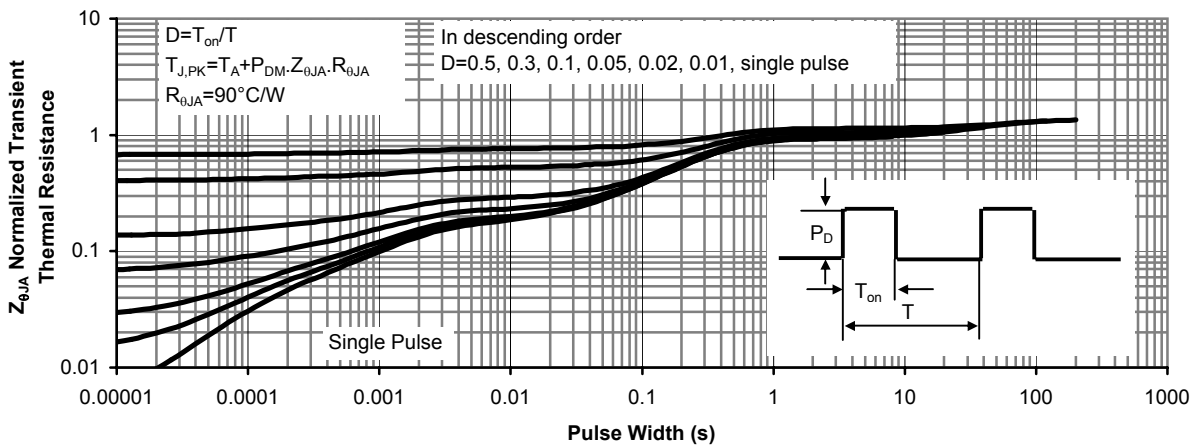
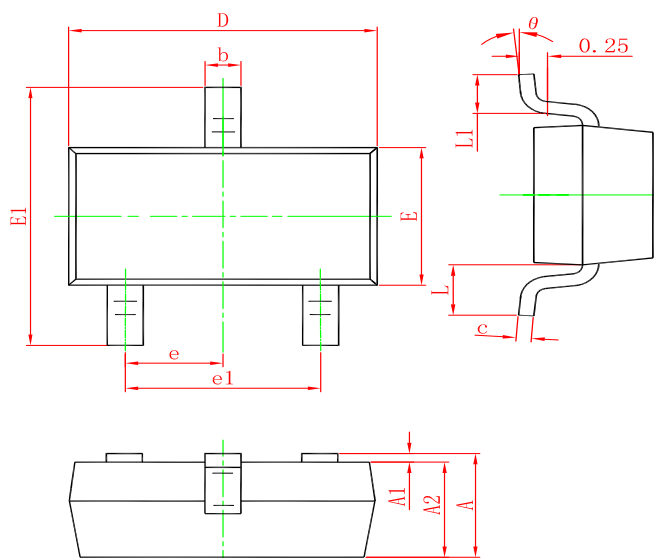

Figure 11: Normalized Maximum Transient Thermal Impedance

SOT-23 PACKAGE OUTLINE DIMENSIONS



Symbol	Dimensions In Millimeters		Dimensions In Inches	
	Min.	Max.	Min.	Max.
A	0.900	1.150	0.035	0.045
A1	0.000	0.100	0.000	0.004
A2	0.900	1.050	0.035	0.041
b	0.300	0.500	0.012	0.020
c	0.080	0.150	0.003	0.006
D	2.800	3.000	0.110	0.118
E	1.200	1.400	0.047	0.055
E1	2.250	2.550	0.089	0.100
e	0.950 TYP.		0.037 TYP.	
e1	1.800	2.000	0.071	0.079
L	0.550 REF.		0.022 REF.	
L1	0.300	0.500	0.012	0.020
θ	0°	8°	0°	8°

Marking

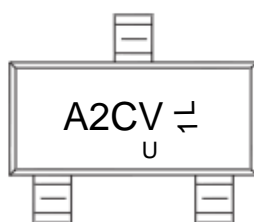

Ordering information

Order code	Package	Baseqty	Deliverymode
UMW AO3402A	SOT-23	3000	Tape and reel