

SOT-23 Plastic-Encapsulate MOSFETS

■ Features

- $V_{DS} (V) = -40V$
- $R_{DS(ON)} < 70m\Omega (V_{GS} = 10V), I_D = -4.4A$
- $R_{DS(ON)} < 95m\Omega (V_{GS} = 4.5V), I_D = -3.5A$

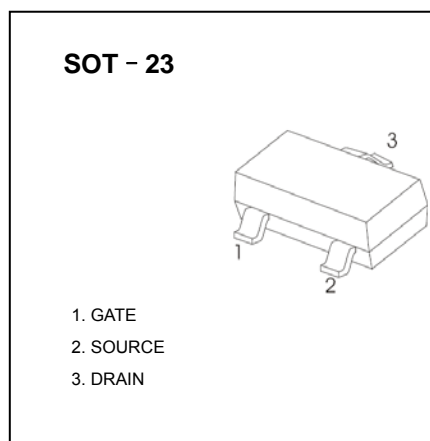

Equivalent Circuit

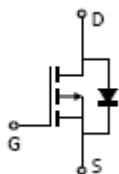

Maximum ratings (Ta=25°C unless otherwise noted)

Parameter	Symbol	Value	Unit
Drain-Source Voltage	VDS	-40	V
Gate-Source Voltage	VGS	±20	
Continuous Drain Current	ID	-4.4	A
Pulsed Diode Current	IDM	-12	
Continuous Source-Drain Current(Diode Conduction)	IS	-1.25	
Power Dissipation	PD	1.25	W
Thermal Resistance from Junction to Ambient (t?5s)	RthJF	166	°C/W
Operating Junction	TJ	150	°C
Storage Temperature	TSTG	-55 ~ +150	°C

MOSFET ELECTRICAL CHARACTERISTICS

Static Electrical Characteristics (Ta = 25 °C Unless Otherwise Noted)

Parameter	Symbol	Test Condition	Min	Typ	Max	Unit
Static						
Drain-source breakdown voltage	V(BR)DSS	VGS = 0V, ID = -250μA	-40			V
Gate-source threshold voltage	VGS(th)	VDS = VGS, ID = -250μA	-1		-3	V
Gate-source leakage	IGSS	VDS = 0V, VGS = ±20V			±100	nA
Zero gate voltage drain current	IDSS	VDS = -40V, VGS = 0V			-1	μA
Drain-source on-state resistancea	RDS(on)	VGS = -10V, ID = -4.4A			70	mΩ
		VGS = -4.5V, ID = -3.5A			95	mΩ
Forward transconductancea	gfs	VDS = -5V, ID = -3A		7		S
Diode forward voltage	VSD	IS = -1.25A, VGS = 0V		-0.8	-1.25	V
Dynamic						
Input capacitance	Ciss	VDS = -20V, VGS = 0V, f = 1MHz		470		pF
Output capacitance	Coss			85		pF
Reverse transfer capacitanceb	Crss			65		pF
Total gate charge	Qg	VDS = -20V, VGS = -10V, ID = -3A		11.5	17	nC
Gate-source charge	Qgs			1.8		nC
Gate-drain charge	Qgd			3.3		nC
Gate resistance	Rg	f = 1MHz		9		?
Switchingb						
Turn-on delay time	td(on)	VDS = -20V, RL = 20Ω, ID = -1A, VGEN = -4.5V, Rg = 6Ω		7	15	ns
Rise time	tr			15	25	ns
Turn-off delay time	td(off)			25	40	ns
Fall time	tf			25	42	ns
Drain-source body diode characteristics						
Continuous Source-Drain Diode Current	IS	Tc = 25°C			-1.25	A
Pulsed Diode forward Current	ISM				-20	A

Note :

1. Repetitive Rating : Pulse width limited by maximum junction temperature.
2. Surface Mounted on FR4 Board, t < 5 sec.
3. Pulse Test : Pulse Width ≤ 300μs, Duty Cycle ≤ 2%.
4. Guaranteed by design, not subject to production testing.

TYPICAL ELECTRICAL AND THERMAL CHARACTERISTICS

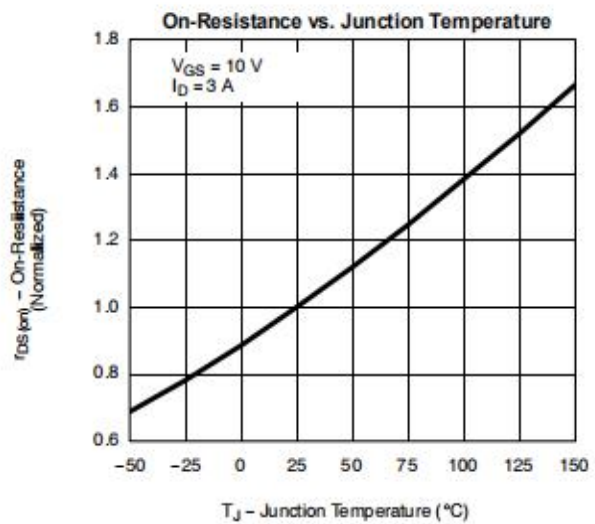
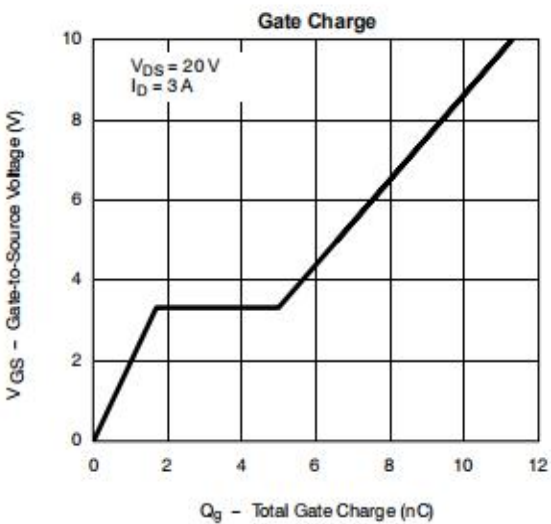
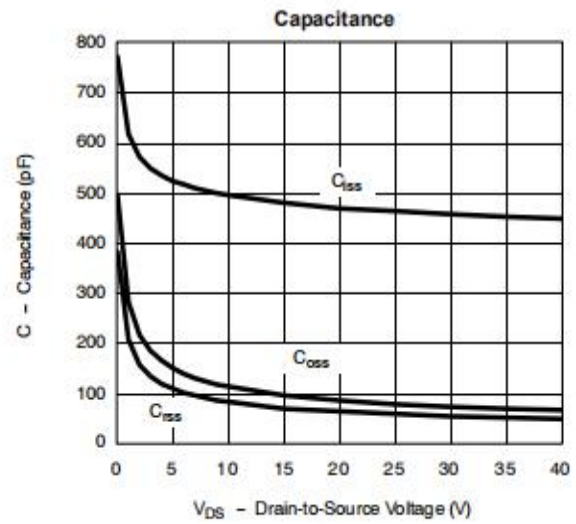
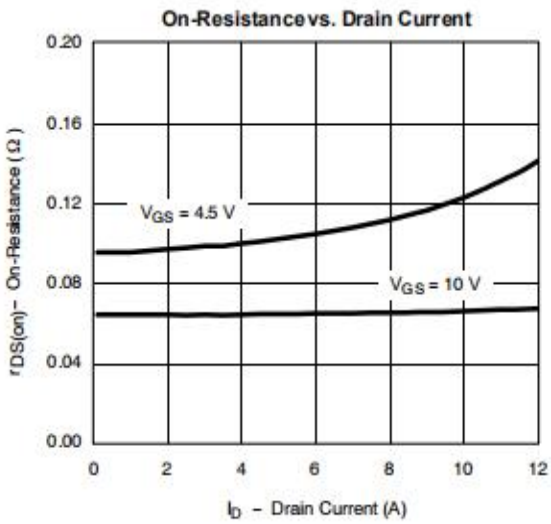
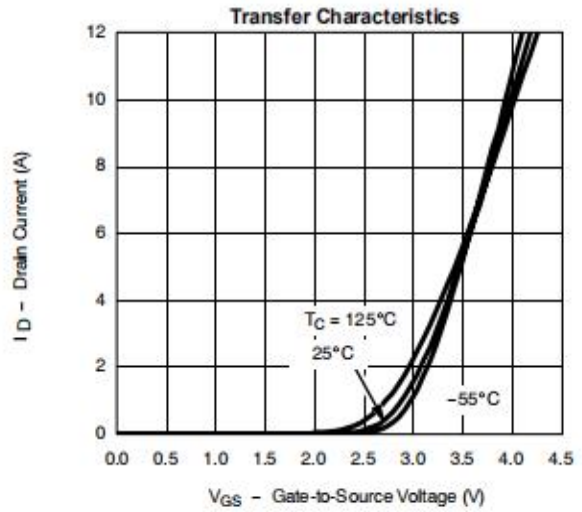
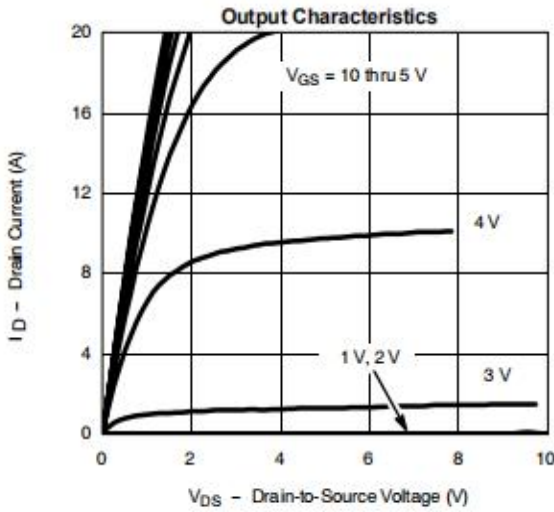

TYPICAL ELECTRICAL AND THERMAL CHARACTERISTICS

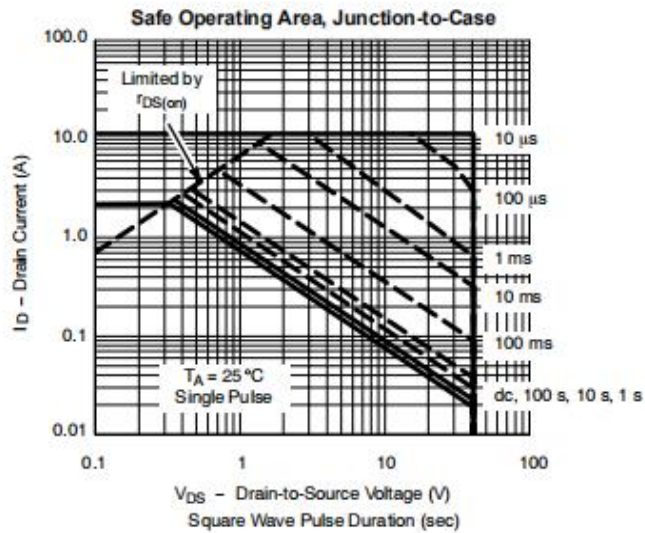
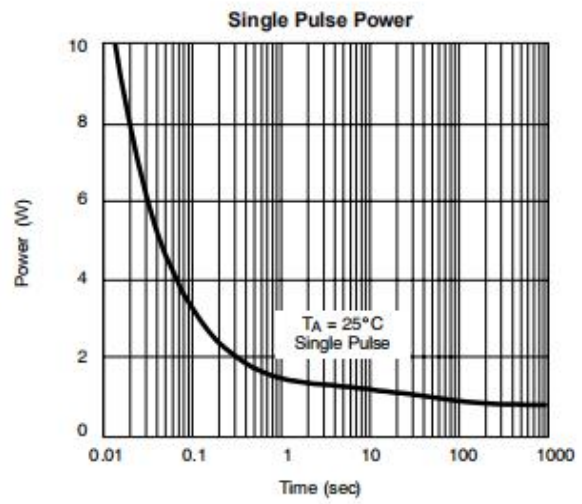
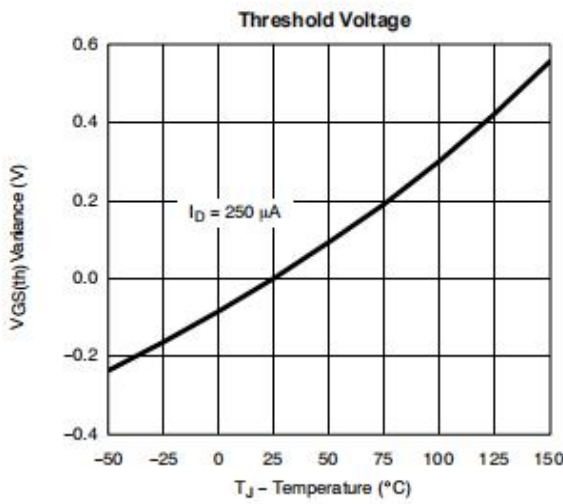
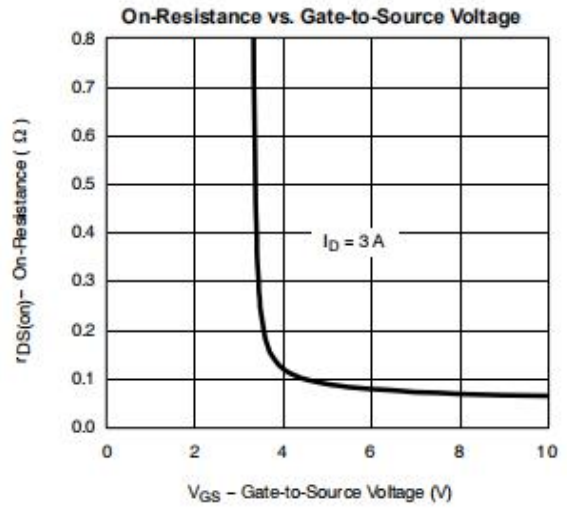
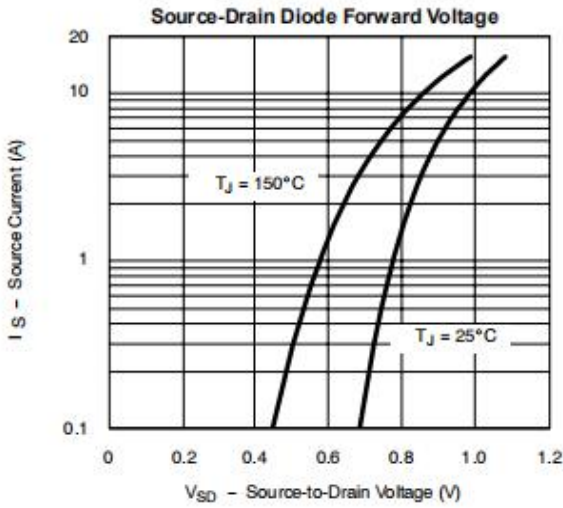

TYPICAL ELECTRICAL AND THERMAL CHARACTERISTICS

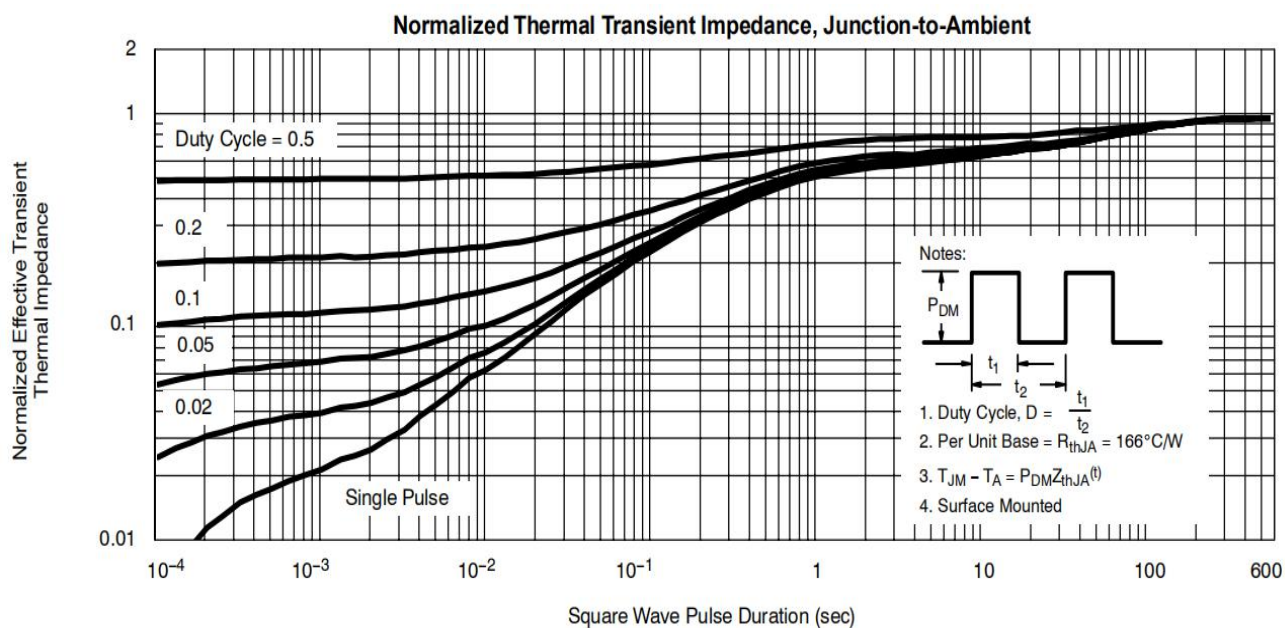

SOT-23 PACKAGE OUTLINE DIMENSIONS

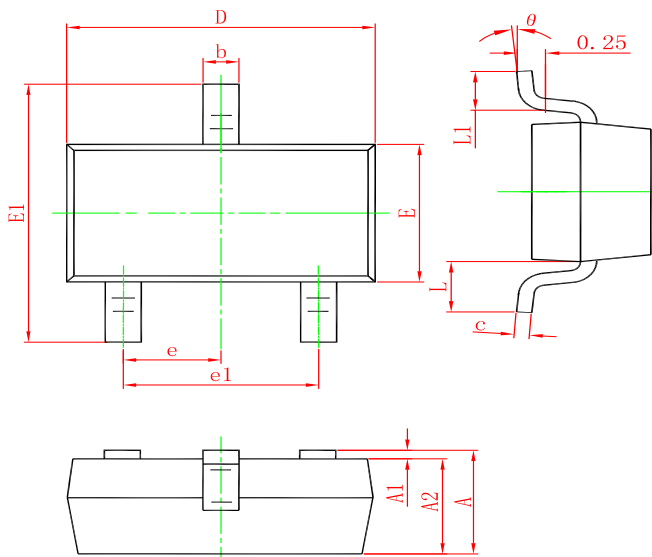

Symbol	Dimensions In Millimeters		Dimensions In Inches	
	Min.	Max.	Min.	Max.
A	0.900	1.150	0.035	0.045
A1	0.000	0.100	0.000	0.004
A2	0.900	1.050	0.035	0.041
b	0.300	0.500	0.012	0.020
c	0.080	0.150	0.003	0.006
D	2.800	3.000	0.110	0.118
E	1.200	1.400	0.047	0.055
E1	2.250	2.550	0.089	0.100
e	0.950 TYP.		0.037 TYP.	
e1	1.800	2.000	0.071	0.079
L	0.550 REF.		0.022 REF.	
L1	0.300	0.500	0.012	0.020
θ	0°	8°	0°	8°

Marking

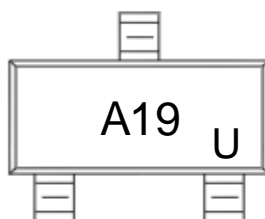

Ordering information

Order code	Package	Baseqty	Deliverymode
UMW SI2319	SOT-23	3000	Tape and reel