

# Slide Potentiometer

Model PSxxM / PSxxL



## Features:

- Molded element
- 100,000 cycle life
- Metal or plastic shaft options
- With/without LED illumination
- With/without dust cover
- RoHS compliant

## Model Styles Available

Dual Gang Without LED	PSxxM
Single Gang With LED	PSxxL

## Electrical

Resistance Range, Ohms	500 -1M
Standard Resistance Tolerance	± 20%
Resistance Tapers	A,B,C
Residual Resistance	Terminals 1 to 2: Less than 10 ohms Terminals 2 to 3: Less than 30 ohms
Input Voltage, Maximum	Linear B taper: 200 Vac Other tapers: 150 Vac
Power rating, Watts (Single Unit / Dual Unit)	<b>Linear B taper:</b> 20mm: 0.1W / 0.05W, 30mm: 0.2W / 0.1W 45mm: 0.25W / 0.125W, 60mm: 0.2W / 0.2W <b>Other tapers:</b> 20mm: 0.05W / 0.025W, 30mm: 0.1W / 0.05W 45mm: 0.125W / 0.06W, 60mm: 0.1W / 0.1W
Dielectric Strength	300Vac, 1 minute
Insulation Resistance, Minimum	10M ohms at 250Vdc/ 1 minute
Sliding Noise	Less than 100mV
Gang Error	±3dB (-40dB to 0dB)

## Mechanical

Static Stop Strength, Minimum	5.0 Kg/cm
Operating Force	10gf to 100gf
Detent Slip-out force	30gf to 200gf

## Durability

Sliding Life	100,000 cycles
--------------	----------------

General Note  
TT Electronics reserves the right to make changes in product specification without notice or liability. All information is subject to TT Electronics' own data and is considered accurate at time of going to print.

TT Electronics | BI Technologies  
Circulo de la Amistad #102 PIMSA IV Mexicali B.C. Mexico C.P 21210  
Ph: +1 714 447 2345  
www.ttelectronics.com/bi-technologies

# Slide Potentiometer

Model PSxxM / PSxxL



## Ordering

### Model PSxxM (Without LED)

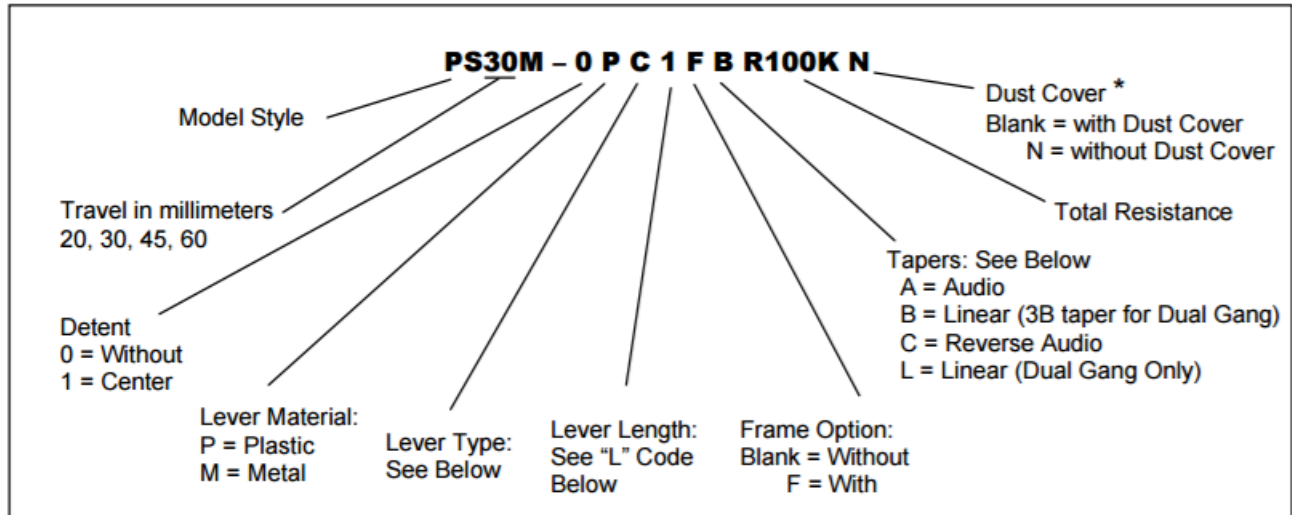

### Model PSxxL (With LED)

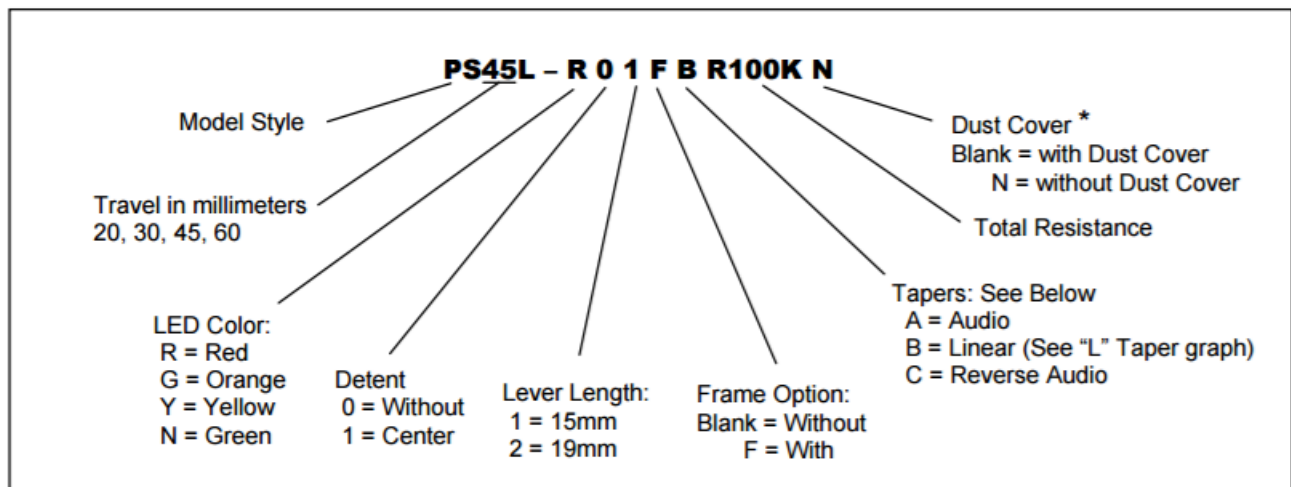

### Standard Resistance Values, ohms

500	1K	2K	5K	10K	20K	50K	100K	200K	500K	1 MEG
-----	----	----	----	-----	-----	-----	------	------	------	-------

# Slide Potentiometer

Model PSxxM / PSxxL



## Tapers

For Dual Gang units ONLY, the Standard Taper is a 3B taper  
If Linear Taper is desired, use "L" taper option



### General Note

TT Electronics reserves the right to make changes in product specification without notice or liability. All information is subject to TT Electronics' own data and is considered accurate at time of going to print.

### Outline Drawings

#### Plastic Lever Types (For PSxxM Only)

E-Type		B-Type		C-Type		D-Type	
L	5.0	L	15	L	10 15	L	10 15
CODE	1	CODE	1	CODE	1 2	CODE	1 2

**Dust Cover option not offered for levers less than 10 mm in length**

#### Metal Lever Types (For PSxxM Only)

D-Type				C-Type			
L	15	20	25	F	5	10	10
L	10	15	20	L	10	15	20
CODE	1	2	3	CODE	1	2	3

**\* Dust Cover option not offered for levers less than 10 mm in length**

# Slide Potentiometer

Model PSxxM / PSxxL



## Outline Drawings

### Model PSxxM (Without LED)

#### With Dust Cover

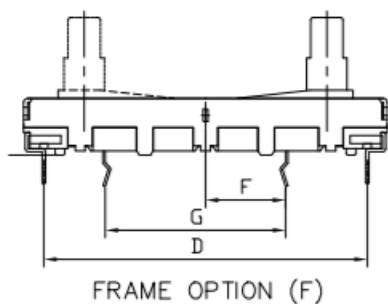
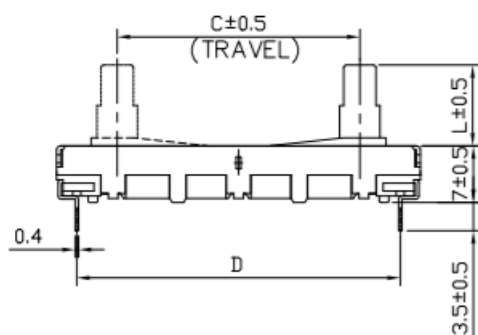
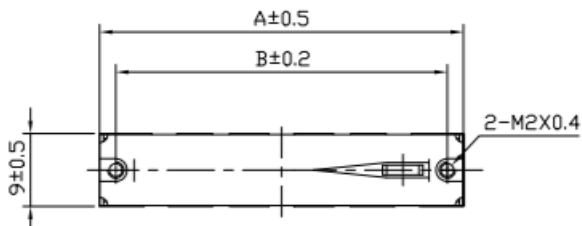

#### Without Dust Cover

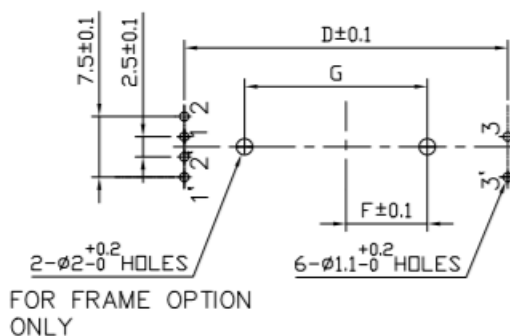
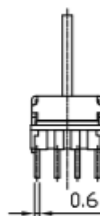
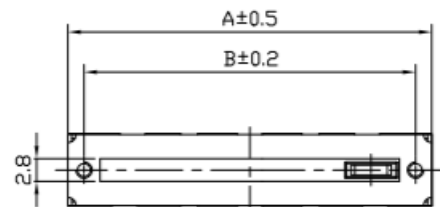

### For PSxxM and PSxxL

MODEL	A	B	C	D	F	G
PS20M PS20L	35	31	20	30	5	12.5
PS30M PS30L	45	41	30	40	10	22.5
PS45M PS45L	60	56	45	55	15	32.5
PS60M PS60L	75	71	60	70	22.5	47.5

General Note  
 TT Electronics reserves the right to make changes in product specification without notice or liability. All information is subject to TT Electronics' own data and is considered accurate at time of going to print.

TT Electronics | BI Technologies  
 Circulo de la Amistad #102 PIMSA IV Mexicali B.C. Mexico C.P 21210  
 Ph: +1 714 447 2345  
[www.ttelectronics.com/bi-technologies](http://www.ttelectronics.com/bi-technologies)

# Slide Potentiometer

Model PSxxM / PSxxL



## Outline Drawings

### Model PSxxL (With LED)

#### With Dust Cover

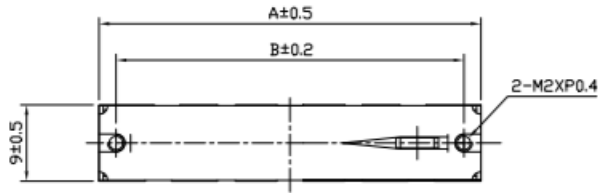

#### Without Dust Cover

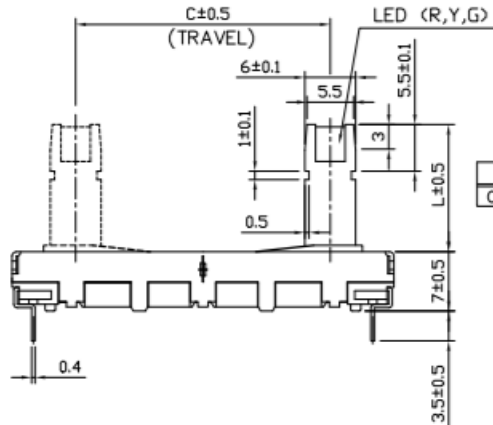
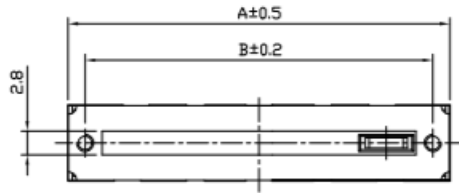

L	15	19
CODE	1	2

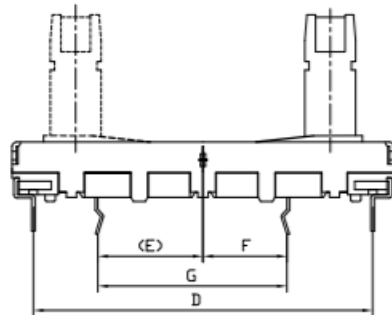
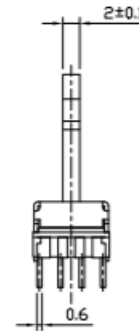

FRAME OPTION (F)

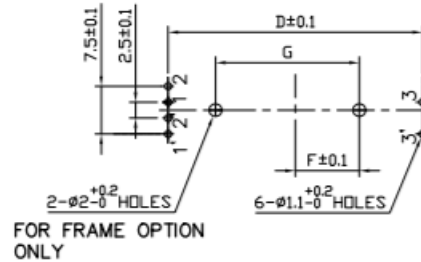

### PSxxL (Single gang with LED)

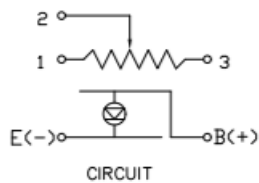

### PSxxM (Dual gang)

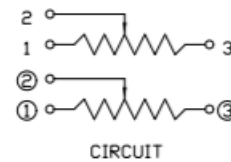

General Note  
TT Electronics reserves the right to make changes in product specification without notice or liability. All information is subject to TT Electronics' own data and is considered accurate at time of going to print.

TT Electronics | BI Technologies  
Circulo de la Amistad #102 PIMSA IV Mexicali B.C. Mexico C.P 21210  
Ph: +1 714 447 2345  
www.ttelectronics.com/bi-technologies