

## Features

- For surface mounted applications in order to optimize board space.
- Low profile package.
- Excellent clamping capability.
- IEC61000-4-2 ESD 30kV Air, 30kV contact compliance
- Protects one I/O line
- Lead-free parts meet RoHS requirements.
- Compliant to Halogen-free

## Applications

- Personal digital assistants (PDA)
- Cellular handsets & Accessories
- Portable devices
- Portable instrumentation
- Handhelds and notebooks
- Digital cameras

## Mechanical data

- Epoxy : UL94-V0 rated flame retardant
- Case : Molded plastic, SOD-123
- Terminals :Plated terminals, solderable per MIL-STD-750, Method 2026
- Polarity : Indicated by cathode band
- Mounting Position : Any

## Package outline

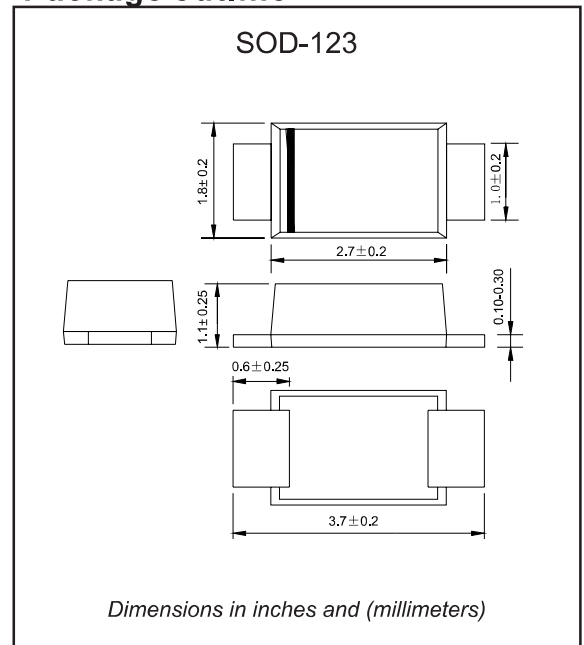

## Maximum ratings and Electrical Characteristics (AT $T_A=25^{\circ}\text{C}$ unless otherwise noted)

PARAMETER	CONDITIONS	Symbol	Value	UNIT
Peak Power Dissipation	Peak Pulse Power Dissipation at $T_A=25^{\circ}\text{C}$ by $10 \times 1000\mu\text{s}$ (Note 1)	$P_{PPM}$	400	W
Operating junction temperature range		$T_J$	-55 to +150	$^{\circ}\text{C}$
Storage temperature range		$T_{STG}$	-55 to +150	$^{\circ}\text{C}$

Note: 1. Non-repetitive current pulse, per Fig. 2 and derated above  $T_A=25^{\circ}\text{C}$  per Fig. 1

## 400W Surface Mount Unidirectional and Bidirectional Transient Voltage Suppressors Diodes- 5.0V- 100V

■ **Electrical Characteristics** TA=25°C unless otherwise noted

Part Number		Marking		Breakdown Voltage $V_{BR}@I_T$			Maximum Reverse Leakage $I_R @ V_{RWM}$ ( $\mu A$ )	Working Peak Reverse Voltage $V_{RWM}$ (V)	Maximum Reverse Surge Current $I_{PP}^{(2)}$ (A)	Maximum Clamping Voltage $V_C @ I_{PP}$ (V)
(Uni)	(Bi)	(Uni)	(Bi)	Min(V)	Max (V)	$I_T^{(1)}$ (mA)				
SMF4L5.0A	SMF4L5.0CA	A2	F5.0CA	6.40	7.00	10	500	5.0	9.2	43.6
SMF4L6.0A	SMF4L6.0CA	A3	F6.0CA	6.67	7.37	10	400	6.0	10.3	38.8
SMF4L6.5A	SMF4L6.5CA	A4	F6.5CA	7.22	7.79	10	350	6.5	11.2	35.8
SMF4L7.0A	SMF4L7.0CA	A5	F7.0CA	7.78	8.60	10	200	7.0	12.0	33.4
SMF4L7.5A	SMF4L7.5CA	A6	F7.5CA	8.33	9.21	1	100	7.5	12.9	31.0
SMF4L8.0A	SMF4L8.0CA	A7	F8.0CA	8.89	9.83	1	50	8.0	13.6	29.4
SMF4L8.5A	SMF4L8.5CA	A8	F8.5CA	9.44	10.4	1	20	8.5	14.4	27.8
SMF4L9.0A	SMF4L9.0CA	A9	F9.0CA	10.00	11.10	1	10	9.0	15.4	26.0
SMF4L10A	SMF4L10CA	AA	F10CA	11.10	12.30	1	2.5	10.0	23.52	17.0
SMF4L11A	SMF4L11CA	AB	F11CA	12.20	13.50	1	2.5	11.0	21.98	18.2
SMF4L12A	SMF4L12CA	AC	F12CA	13.30	14.70	1	2.5	12.0	20.1	19.9
SMF4L13A	SMF4L13CA	AD	F13CA	14.40	15.90	1	1.0	13.0	18.6	20.0
SMF4L14A	SMF4L14CA	AE	F14CA	15.60	17.20	1	1.0	14.0	17.24	23.2
SMF4L15A	SMF4L15CA	AF	F15CA	16.70	18.50	1	1.0	15.0	16.4	24.4
SMF4L16A	SMF4L16CA	AG	F16CA	17.80	19.70	1	1.0	16.0	15.38	26.0
SMF4L17A	SMF4L17CA	AH	F17CA	18.90	20.90	1	1.0	17.0	14.5	27.6
SMF4L18A	SMF4L18CA	AK	F18CA	20.00	22.10	1	1.0	18.0	13.7	29.2
SMF4L19A	SMF4L19CA	F19A	F19CA	21.10	23.30	1	1.0	19.0	13.08	30.6
SMF4L20A	SMF4L20CA	AL	F20CA	22.20	24.50	1	1.0	20.0	12.34	32.4
SMF4L22A	SMF4L22CA	AM	F22CA	24.40	26.90	1	1.0	22.0	11.26	35.5
SMF4L24A	SMF4L24CA	AN	F24CA	26.70	29.50	1	1.0	24.0	10.28	38.9
SMF4L26A	SMF4L26CA	AP	F26CA	28.90	31.90	1	1.0	26.0	9.5	42.1
SMF4L28A	SMF4L28CA	AR	F28CA	31.10	34.40	1	1.0	28.0	8.82	45.4
SMF4L30A	SMF4L30CA	AS	F30CA	33.30	36.80	1	1.0	30.0	8.26	48.4
SMF4L33A	SMF4L33CA	AT	F33CA	36.70	40.60	1	1.0	33.0	7.5	53.3
SMF4L36A	SMF4L36CA	AU	F36CA	40.00	44.20	1	1.0	36.0	6.88	58.1
SMF4L40A	SMF4L40CA	AV	F40CA	44.40	49.10	1	1.0	40.0	6.2	64.5

■ **Electrical Characteristics** TA=25°C unless otherwise noted

Part Number		Marking		Breakdown Voltage $V_{BR}@I_T$			Maximum Reverse Leakage $I_R @ V_{RWM}$ ( $\mu A$ )	Working Peak Reverse Voltage $V_{RWM}$ (V)	Maximum Reverse Surge Current $I_{PP}^{(2)}$ (A)	Maximum Clamping Voltage $V_C @ I_{PP}$ (V)
(Uni)	(Bi)	(Uni)	(Bi)	Min(V)	Max (V)	$I_T^{(1)}$ (mA)				
SMF4L43A	SMF4L43CA	AW	F43CA	47.80	52.80	1	1.0	43.0	5.76	69.4
SMF4L45A	SMF4L45CA	AX	F45CA	50.00	55.30	1	1.0	45.0	5.5	72.7
SMF4L48A	SMF4L48CA	AY	4VX	53.30	58.90	1	1.0	48.0	5.16	77.4
SMF4L51A	SMF4L51CA	AZ	4VZ	56.70	62.70	1	1.0	51.0	4.86	82.4
SMF4L54A	SMF4L54CA	B1	4WE	60.00	66.30	1	1.0	54.0	4.6	87.1
SMF4L58A	SMF4L58CA	B2	4WG	64.40	71.20	1	1.0	58.0	4.28	93.6
SMF4L60A	SMF4L60CA	B3	4WK	66.70	73.70	1	1.0	60.0	4.14	96.8
SMF4L64A	SMF4L64CA	B4	4WM	71.10	78.60	1	1.0	64.0	3.88	103.0
SMF4L70A	SMF4L70CA	B5	4WP	77.80	86.00	1	1.0	70.0	3.54	113.0
SMF4L75A	SMF4L75CA	B6	4WR	83.30	92.10	1	1.0	75.0	3.3	121.0
SMF4L78A	SMF4L78CA	B7	4WT	86.70	95.80	1	1.0	78.0	3.18	126.0
SMF4L80A	SMF4L80CA	B8	4WU	88.80	97.60	1	1.0	80.0	3.1	129.0
SMF4L85A	SMF4L85CA	B9	4WV	94.40	104.00	1	1.0	85.0	2.92	137.0
SMF4L90A	SMF4L90CA	B10	4WX	100.00	111.00	1	1.0	90.0	2.74	146.0
SMF4L100A	SMF4L100CA	B11	4WZ	111.00	123.00	1	1.0	100.0	2.46	162.0

## Rating and characteristic curves

FIG.1 - PULSE DERATING CURVE

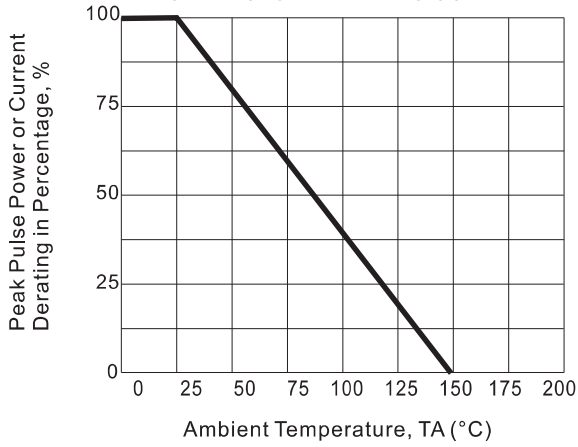

FIG.2 - 10X1000us PULSE WAVEFORM

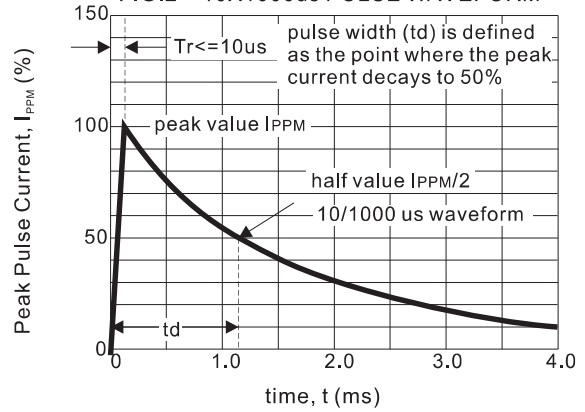

FIG.3 - 8X20us PULSE WAVEFORM

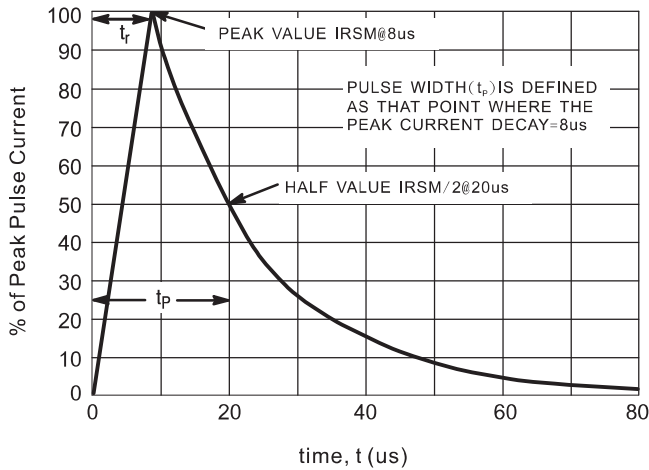

FIG.4 - PEAK PULSE POWER RATING CURVE

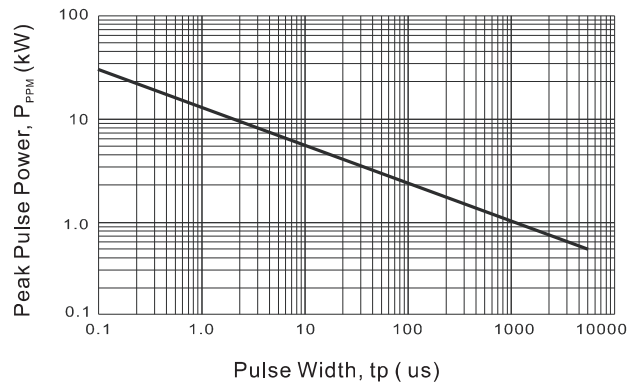
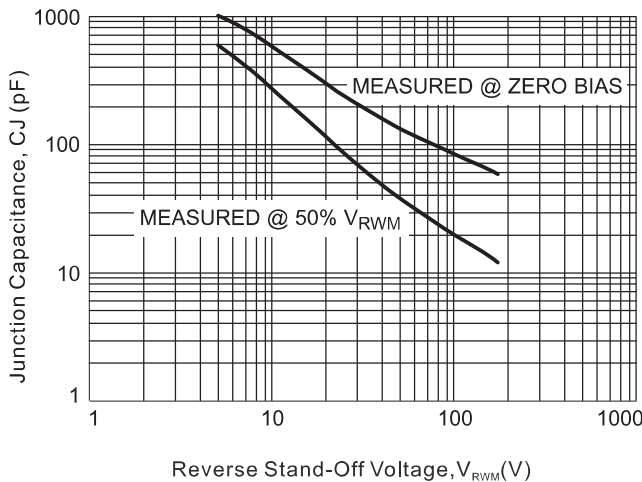





FIG.5 - TYPICAL JUNCTION CAPACITANCE



**Pinning information**

Pin	Simplified outline	Symbol
Uni-Directional Pin1 cathode Pin2 anode		
Bi-Directional		

**Suggested solder pad layout**

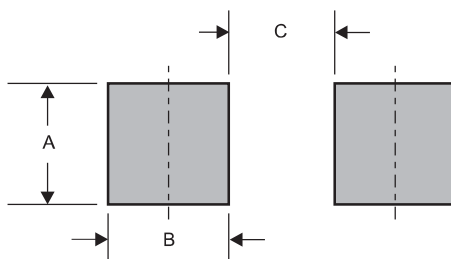

Dimensions in inches and (millimeters)

PACKAGE	A	B	C
SOD-123	0.044 (1.10)	0.040 (1.00)	0.079 (2.00)

**Suggested thermal profiles for soldering processes**

- 1.Storage environment: Temperature=5°C~40°C Humidity=55%±25%
- 2.Reflow soldering of surface-mount devices

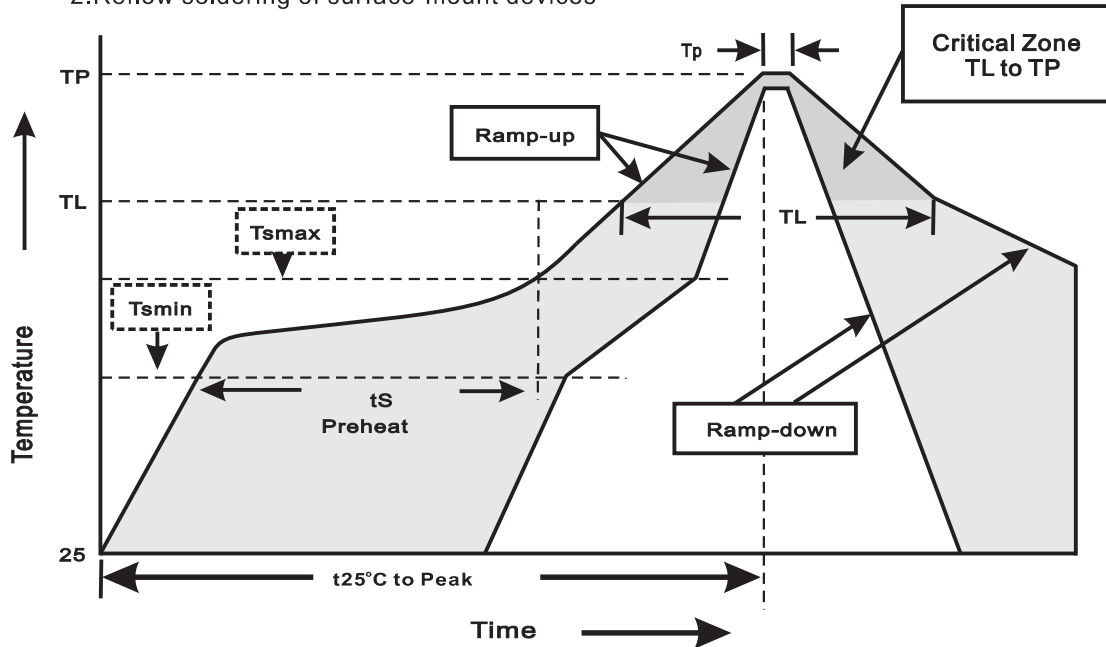

3.Reflow soldering

Profile Feature	Soldering Condition
Average ramp-up rate(T <sub>L</sub> to T <sub>P</sub> )	<3°C/sec
Preheat -Temperature Min(T <sub>smin</sub> ) -Temperature Max(T <sub>smax</sub> ) -Time(min to max)(t <sub>s</sub> )	150°C 200°C 60~120sec
T <sub>smax</sub> to T <sub>L</sub> -Ramp-upRate	<3°C/sec
Time maintained above: -Temperature(T <sub>L</sub> ) -Time(t <sub>L</sub> )	217°C 60~260sec
Peak Temperature(T <sub>P</sub> )	255°C-0/+5°C
Time within 5°C of actual Peak Temperature(t <sub>P</sub> )	10~30sec
Ramp-down Rate	<6°C/sec
Time 25°C to Peak Temperature	<6minutes