

SiT1579

1.2 mm² μ Power, Low-Jitter, 1 Hz – 2.5 MHz Oscillator



Features

- 1 Hz to 2.5 MHz \pm 50 ppm all-inclusive frequency stability
- Factory programmable output frequency
- World's smallest Oscillator Footprint: 1.2 mm²
 - 1.5 x 0.8 mm CSP
 - No external bypass cap required
- Improved stability reduces system power with fewer network timekeeping updates
- Ultra-low power: 6 μ A (100 kHz)
- Supply voltage range: 1.62 V to 3.63 V
- Operating temperature ranges: -20°C to +70°C, -40°C to +85°C
- Pb-free, RoHS and REACH compliant

Applications

- Health and wellness monitors
- Smart pens
- ULP input devices
- Proprietary wireless
- Sensor interface



Electrical Characteristics

Table 1. Electrical Characteristics

Conditions: Min/Max limits are over temperature, $V_{DD} = 1.8 \text{ V} \pm 10\%$, unless otherwise stated. Typicals are at 25°C and $V_{DD} = 1.8 \text{ V}$.

Parameter	Symbol	Min.	Typ.	Max.	Unit	Condition	
Frequency and Stability							
Output Frequency	F_{OUT}	1		2.5 M	Hz		
Initial Frequency Tolerance	F_{tol}	-10		10	ppm	Includes 2x reflow	
Frequency Stability	F_{stab}	-50		50	ppm	All inclusive of over temperature, referenced to nominal frequency at 25°C, inclusive of V_{DD} , aging, and load	
Jitter Performance							
Integrated Phase Jitter	IPJ		2	3.5	n_{SRMS}	$F_{OUT} > 1 \text{ kHz}$. Integration bandwidth = 100 Hz to $F_{OUT} / 2$. Inclusive of 50 mV peak-to-peak sinusoidal noise on V_{DD} . Noise frequency 100 Hz to 20 MHz	
RMS Period Jitter	PJ		2.2	4.5	n_{SRMS}	Cycles = 10,000, $f = 100 \text{ kHz}$. Per JEDEC standard 65B, tested at 100 kHz. See performance plot for other frequencies.	
Supply Voltage and Current Consumption							
Operating Supply Voltage	V_{DD}	1.62		3.63	V		
No Load Supply Current	I_{DD}			3.65	5	μ A	$F_{OUT} = 1 \text{ Hz}$
				4.5	5.5		$F_{OUT} = 33 \text{ kHz}$
				6	7		$F_{OUT} = 100 \text{ kHz}$
				13	16		$F_{OUT} = 1 \text{ MHz}$
				33	40		$F_{OUT} = 2 \text{ MHz}$
Start-up Time at Power-up	t_{start}			150	300	ms	Measured when supply reaches 90% of final V_{DD} to the first output pulse and within specified min/max frequency limit.
				300 + 2.0 cycles	300 + 2.5 cycles		10 Hz < $F_{OUT} \leq 200 \text{ Hz}$, to first output pulse. Measured when supply reaches 90% of final V_{DD} to the first output pulse and within specified min/max frequency limit.
					500 + 3 cycles		1 Hz $\leq F_{OUT} \leq 10 \text{ Hz}$, to first output pulse. Measured when supply reaches 90% of final V_{DD} to the first output pulse and within specified min/max frequency limit.
Operating Temperature Range							
Operating Temperature Range	Op_Temp	-20		70	°C	"C" ordering code	
		-40		85	°C	"I" ordering code	
LVC MOS Output							
Output Rise/Fall Time	t_R, t_F		9	20	ns	20-80%, 15 pF load, $V_{DD} = 1.8 \text{ V} \pm 10\%$	
Output Clock Duty Cycle	DC	45		55	%		
Output Voltage High	V_{OH}	90%			V_{DD}	$I_{OH} = -50 \mu\text{A}$, 15 pF load	
Output Voltage Low	V_{OL}			10%	V_{DD}	$I_{OL} = 50 \mu\text{A}$, 15 pF load	

Note:

- Includes initial tolerance, over temp stability, 2x reflow, V_{DD} range, board-level underfill, and 20% load variation. Tested with Agilent 53132A frequency counter. Measured with $\geq 100 \text{ ms}$ gate time for accurate frequency measurement.

Table 2. Pin Configuration

Pin	Symbol	I/O	Functionality
1	NC	Internal Test	No Connect. Leave floating. Pin 1 is for internal testing and is designed to be left floating.
2	CLK Out	OUT	Oscillator clock output.
3	V _{DD}	Power Supply	Operates from nominal supply voltages between 1.8 V and 3.3 V. Under normal operating conditions, V _{DD} does not require external bypass/decoupling capacitor(s). SiT1579 includes on-chip V _{DD} filtering.
4	GND	Power Supply Ground	Connect to ground.

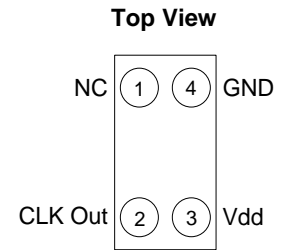

Figure 1. Pin Assignment

Table 3. Absolute Maximum Ratings

Attempted operation outside the absolute maximum ratings may cause permanent damage to the part. Actual performance of the IC is only guaranteed within the operational specifications, not at absolute maximum ratings.

Parameters	Test Conditions	Value	Unit
Continuous Power Supply Voltage Range (V _{DD})		-0.5 to 4.0	V
Continuous Maximum Operating Temperature Range		105	°C
Short Duration Maximum Operating Temperature Range	≤ 30 minutes	125	°C
Human Body Model (HBM) ESD Protection	JESD22-A114	2000	V
Charge-Device Model (CDM) ESD Protection	JESD22-C101	750	V
Machine Model (MM) ESD Protection	JESD22-A115	300	V
Latch-up Tolerance	JESD78 Compliant		
Mechanical Shock Resistance	Mil 883, Method 2002	20,000	g
Mechanical Vibration Resistance	Mil 883, Method 2007	70	g
1508 CSP Junction Temperature		150	°C
Storage Temperature		-65 to 150	°C

System Block Diagram

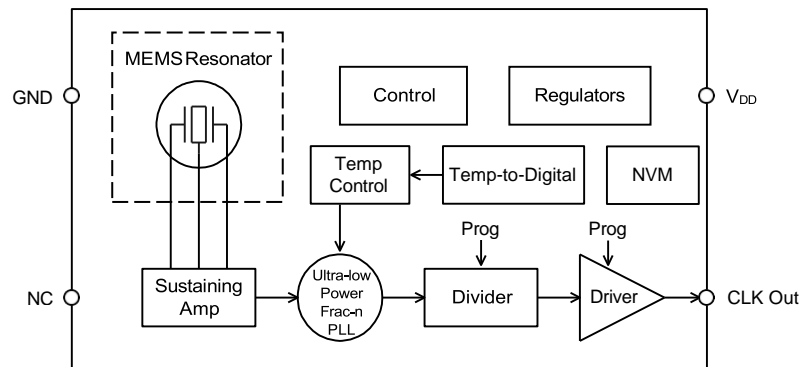

Figure 2. SiT1579 Block Diagram

Description

SiT1579 is an ultra-small and ultra-low power Factory programmable oscillator with an output frequency range between 1 Hz to 2.5 MHz. SiTime's silicon MEMS technology enables the first programmable, μ Power oscillator in the world's smallest footprint and chip-scale packaging (CSP). Typical supply current is only 6 μ A (100 kHz).

SiTime's MEMS oscillator consists of a MEMS resonator and a programmable analog circuit. SiT1579 MEMS resonator is built with SiTime's unique MEMS First[®] process. A key manufacturing step is EpiSeal[®] during which the MEMS resonator is annealed with temperatures over 1000°C. EpiSeal creates an extremely strong, clean, vacuum chamber that encapsulates the MEMS resonator and ensures the best performance and reliability. During EpiSeal, a poly silicon cap is grown on top of the resonator cavity, which eliminates the need for additional cap wafers or other exotic packaging. As a result, SiTime's MEMS resonator die can be used like any other semiconductor die. One unique result of SiTime's MEMS First and EpiSeal manufacturing processes is the capability to integrate SiTime's MEMS die with a SOC, ASIC, microprocessor or analog die within a package to eliminate external timing components and provide a highly integrated, smaller, cheaper solution to the customer.

Frequency Stability

The SiT1579 oscillator is Factory trimmed to 32.768 kHz at room temperature. The result is a very accurate oscillator at room temperature and over temperature. Unlike quartz crystals that have a classic tuning fork parabola temperature curve with a 25°C turnover point with a 0.04 to 0.06 ppm/°C² temperature coefficient (TCF), the SiT1579 temperature coefficient is calibrated at room temperature and corrected over temperature with an active temperature correction circuit. The result is $<\pm 50$ ppm frequency variation over the -40°C to +85°C temperature range.

When measuring the SiT1579 output frequency with a frequency counter, it is important to make sure the counter's gate time is >100 ms. Shorter gate times may lead to inaccurate measurements.

Typical Operating Curves

($T_A = 25^\circ\text{C}$, $V_{DD} = 1.8\text{ V}$, supply current plots are no load, unless otherwise stated)

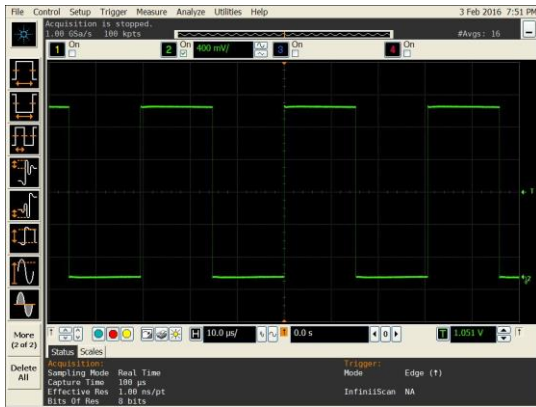

Figure 3. LVC MOS Output Swing ($V_{DD} = 1.8\text{ V}$)

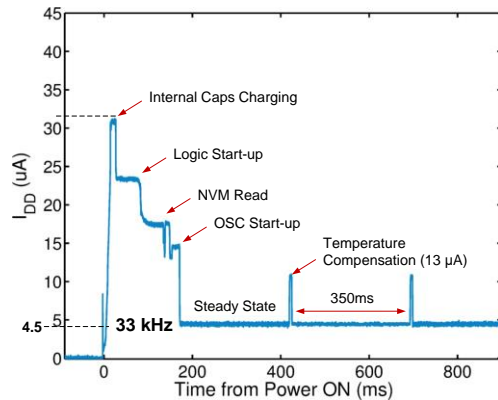

Figure 4. Start-up and Steady-State Current Profile

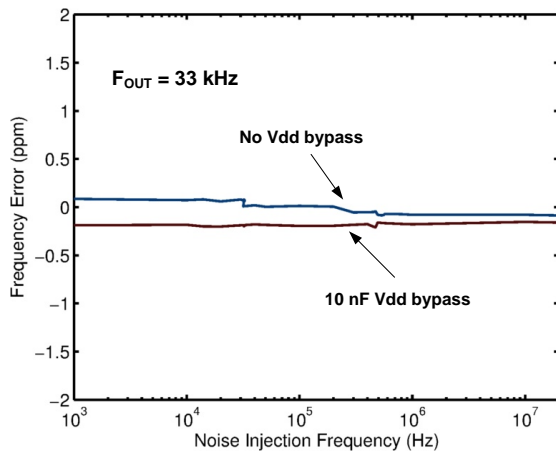

Figure 5. Power Supply Noise Rejection

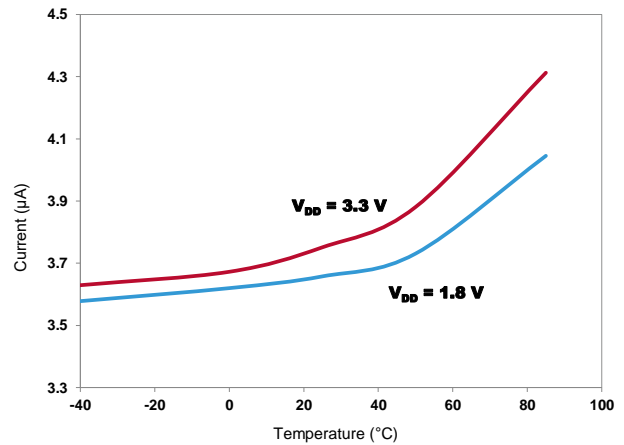

Figure 6. Supply Current vs Temperature ($F_{OUT} = 1\text{ Hz}$)

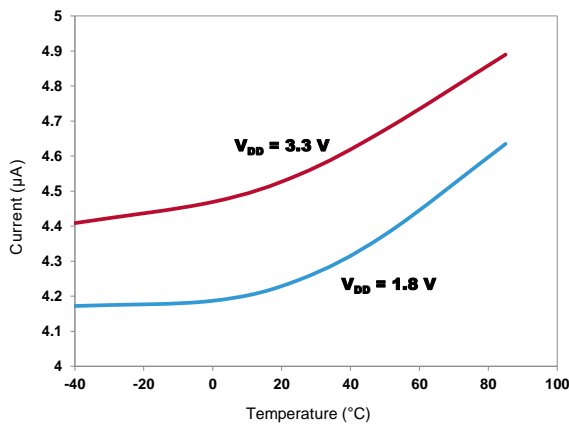

Figure 7. Supply Current vs Temperature ($F_{OUT} = 100\text{ Hz}$)

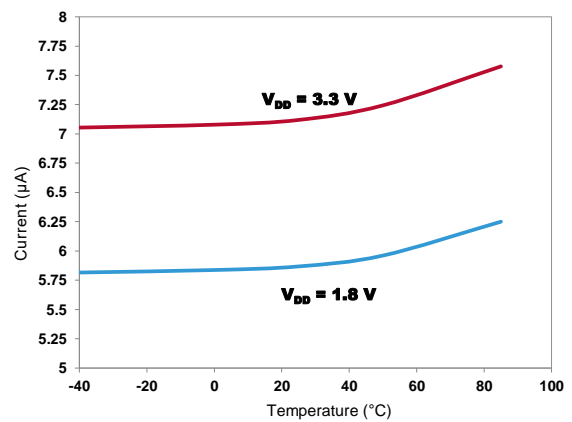

Figure 8. Supply Current vs Temperature ($F_{OUT} = 100\text{ kHz}$)

Typical Operating Curves (continuous)

($T_A = 25^\circ\text{C}$, $V_{DD} = 1.8\text{ V}$, supply current plots are no load, unless otherwise stated)

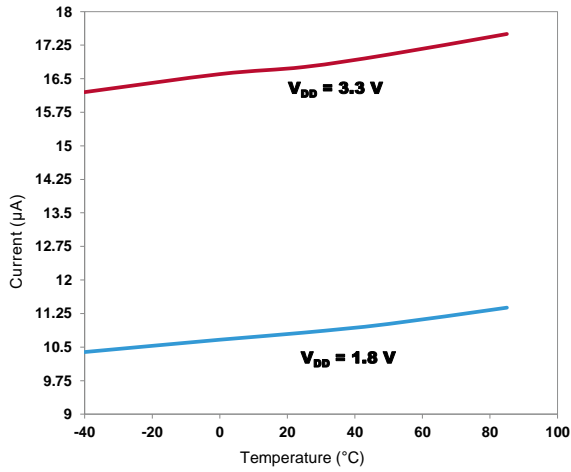

Figure 9. Supply Current vs Temperature
($F_{OUT} = 500\text{ kHz}$)

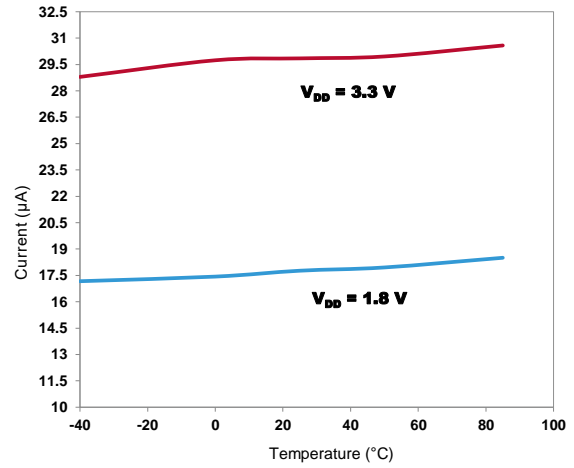

Figure 10. Supply Current vs Temperature
($F_{OUT} = 1\text{ MHz}$)

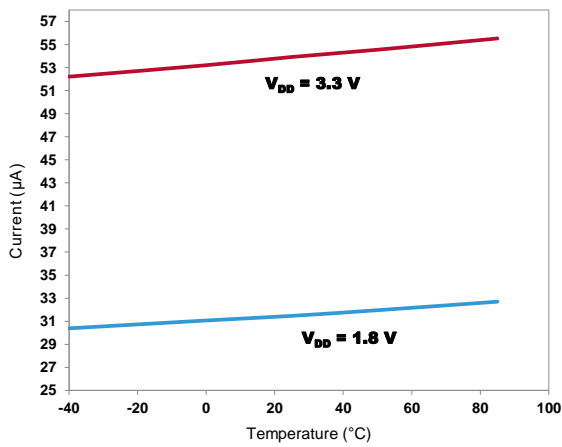

Figure 11. Supply Current vs Temperature
($F_{OUT} = 1.85\text{ MHz}$)

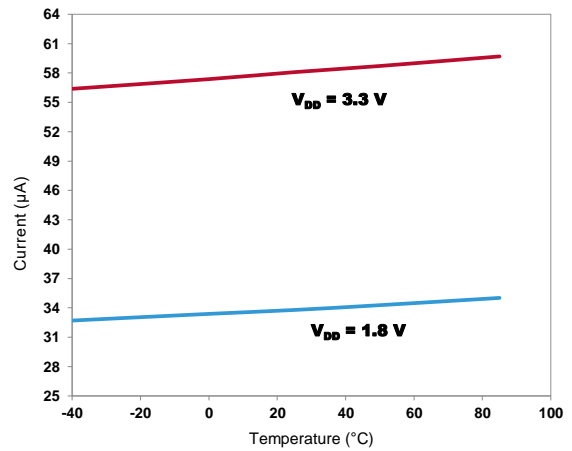
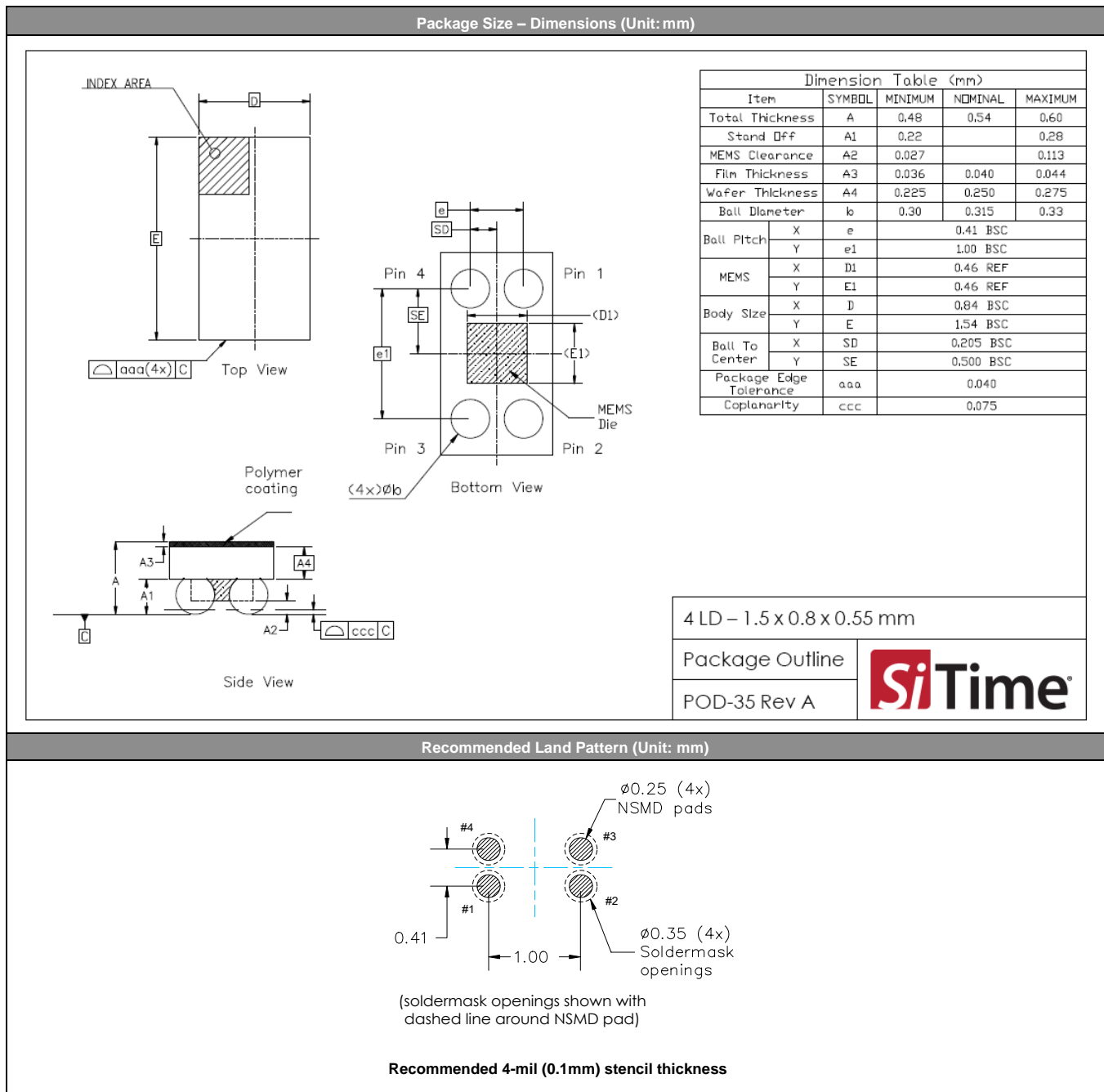

Figure 12. Supply Current vs Temperature
($F_{OUT} = 2\text{ MHz}$)

Dimensions and Patterns



Manufacturing Guidelines

- 1) No Ultrasonic or Megasonic cleaning: Do not subject SiT1579 to an ultrasonic or megasonic cleaning environment. Permanent damage or long term reliability issues may occur.
- 2) Applying board-level underfill and overmold is acceptable and will not impact the reliability of the device.
- 3) Reflow profile, per JESD22-A113D.
- 4) The SiT1579 CSP includes a protective, opaque polymer top-coat. If the SiT1579 will see intense light, especially in the 1.0-1.2 μ m IR spectrum, we recommend a protective “glob-top” epoxy or other cover to keep the light from negatively impacting the frequency stability.
- 5) For additional manufacturing guidelines and marking/tape-reel instructions, refer to [SiTime Manufacturing Notes](#).

Ordering Information

SiT1579AI-J3-XXE-XXXX.XXXXXXQ

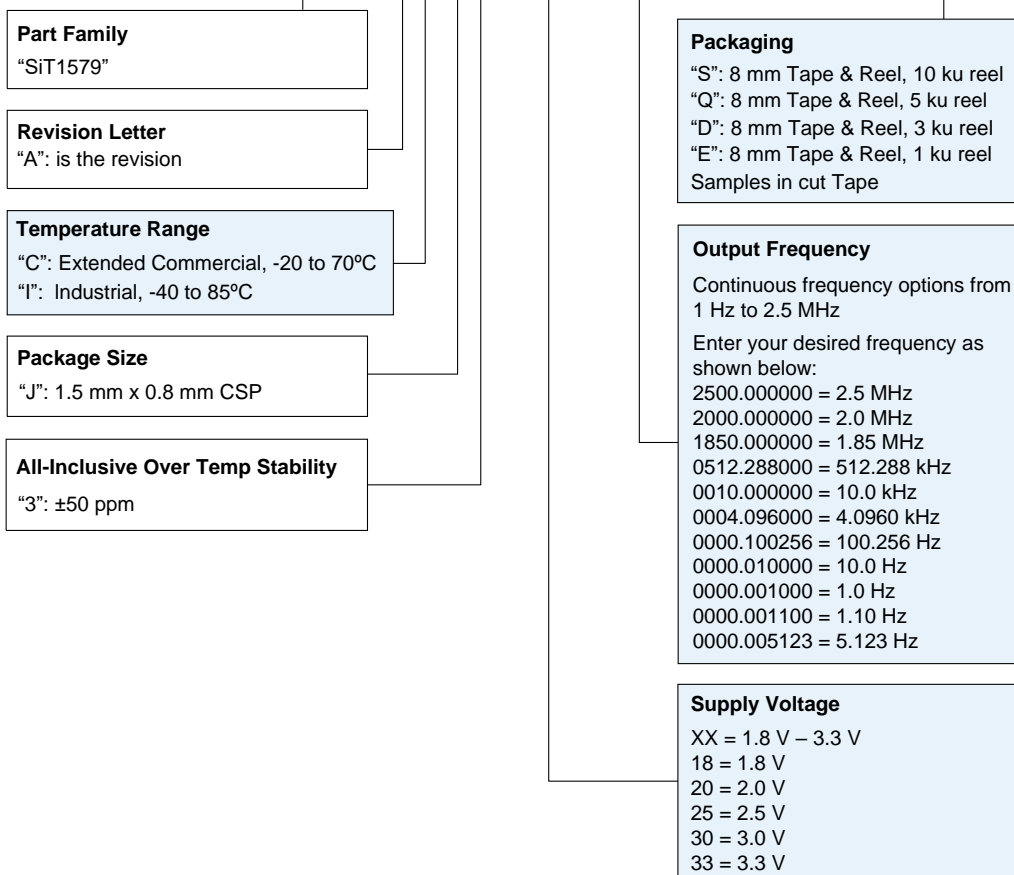

Table 4. Revision History

Version	Release Date	Change Summary
0.9	9-May-2017	Initial Preliminary Datasheet Release
0.95	12-Jun-2017	Updated start-up time typical value
1.0	3-Aug-2017	Final Release Increased maximum output frequency option Added additional typical operating curves Updated typical No Load Supply Current (Table 1)
1.1	22-Jan-2018	Updated the maximum frequency from 2.0 MHz to 2.5 MHz
1.11	29-Mar-2021	Added Option "D" for 3ku reels to the Ordering Information Updated hyperlinks, trademarks, date format and layout formatting

SiTime Corporation, 5451 Patrick Henry Drive, Santa Clara, CA 95054, USA | **Phone:** +1-408-328-4400 | **Fax:** +1-408-328-4439

© SiTime Corporation 2017-2021. The information contained herein is subject to change at any time without notice. SiTime assumes no responsibility or liability for any loss, damage or defect of a Product which is caused in whole or in part by (i) use of any circuitry other than circuitry embodied in a SiTime product, (ii) misuse or abuse including static discharge, neglect or accident, (iii) unauthorized modification or repairs which have been soldered or altered during assembly and are not capable of being tested by SiTime under its normal test conditions, or (iv) improper installation, storage, handling, warehousing or transportation, or (v) being subjected to unusual physical, thermal, or electrical stress.

Disclaimer: SiTime makes no warranty of any kind, express or implied, with regard to this material, and specifically disclaims any and all express or implied warranties, either in fact or by operation of law, statutory or otherwise, including the implied warranties of merchantability and fitness for use or a particular purpose, and any implied warranty arising from course of dealing or usage of trade, as well as any common-law duties relating to accuracy or lack of negligence, with respect to this material, any SiTime product and any product documentation. Products sold by SiTime are not suitable or intended to be used in a life support application or component, to operate nuclear facilities, or in other mission critical applications where human life may be involved or at stake. All sales are made conditioned upon compliance with the critical uses policy set forth below.

CRITICAL USE EXCLUSION POLICY

BUYER AGREES NOT TO USE SITIME'S PRODUCTS FOR ANY APPLICATION OR IN ANY COMPONENTS USED IN LIFE SUPPORT DEVICES OR TO OPERATE NUCLEAR FACILITIES OR FOR USE IN OTHER MISSION-CRITICAL APPLICATIONS OR COMPONENTS WHERE HUMAN LIFE OR PROPERTY MAY BE AT STAKE.

SiTime owns all rights, title and interest to the intellectual property related to SiTime's products, including any software, firmware, copyright, patent, or trademark. The sale of SiTime products does not convey or imply any license under patent or other rights. SiTime retains the copyright and trademark rights in all documents, catalogs and plans supplied pursuant to or ancillary to the sale of products or services by SiTime. Unless otherwise agreed to in writing by SiTime, any reproduction, modification, translation, compilation, or representation of this material shall be strictly prohibited.