

Model 638

Ultra Low Jitter LVPECL or LVDS Clock

Features

- Ceramic Surface Mount Package
- Ultra Low Phase Jitter Performance, 100fs Typical
- Fundamental or 3rd Overtone Crystal Design
- Frequency Range 80 – 170MHz *
- +2.5V or +3.3V Operation
- Output Enable Standard
- Tape and Reel Packaging, EIA-481

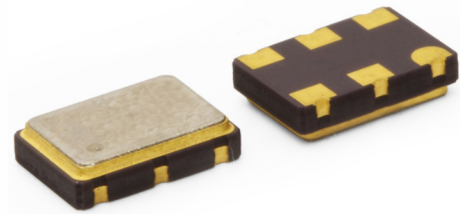

Part Dimensions:
7.0 × 5.0 × 2.0mm • 178.462mg

Standard Frequencies

* See Page 8 for common frequencies.
Check with factory for availability of frequencies not listed.

Applications

- SerDes
- Storage Area Networking
- Broadband Access
- SONET/SDH/DWDM
- PON
- Ethernet/Gbe/SyncE
- Fiber Channel
- Medical Electronics
- Test and Measurement

Description

CTS Model 638 is a low cost, high performance clock oscillator supporting differential LVPECL or LVDS outputs. Employing the latest IC technology, M638 has excellent stability and low jitter/phase noise performance.

Ordering Information

Model	Output Type	Frequency Code [MHz]	Frequency Stability	Temperature Range	Supply Voltage	Packaging
638	P	XXX or XXXX	3	G	3	T
		Code Frequency Product Frequency Code ¹		Code Temp. Range A -10°C to +60°C C -20°C to +70°C I -40°C to +85°C G -40°C to +105°C ³		Code Packing T 1k pcs./reel
	Code Output P LVPECL - Pin 1 Enable L LVDS - Pin 1 Enable E LVPECL - Pin 2 Enable V LVDS - Pin 2 Enable		Code Stability Code Stability 6 ±20ppm ² 4 ±30ppm 5 ±25ppm 3 ±50ppm		Code Voltage M +1.8Vdc ⁴ 2 +2.5Vdc 3 +3.3Vdc	

Notes:

- 1] Refer to document 016-1454-0, Frequency Code Tables. 3-digits for frequencies <100MHz, 4-digits for frequencies 100MHz or greater.
- 2] Check factory for availability. Temperature codes A and C only.
- 3] Check factory for availability. Stability codes 2 and 3 only.
- 4] LVDS output only. Consult factory for availability.

**Not all performance combinations and frequencies may be available.
Contact your local CTS Representative or CTS Customer Service for availability.**

This product is specified for use only in standard commercial applications. Supplier disclaims all express and implied warranties and liability in connection with any use of this product in any non-commercial applications or in any application that may expose the product to conditions that are outside of the tolerances provided in its specification.



Electrical Specifications

Operating Conditions

PARAMETER	SYMBOL	CONDITIONS	MIN	TYP	MAX	UNIT
Maximum Supply Voltage	V _{CC}	-	-0.5	-	5.0	V
Supply Voltage [Note 1]	V _{CC}	±5%	1.710	1.8	1.890	V
			3.135	3.3	3.465	
Supply Current						
LVPECL	I _{CC}	Maximum Load	-	55	88	mA
LVDS			-	45	66	
Operating Temperature	T _A	-	-10		+60	°C
			-20	+25	+70	
			-40		+85	
			-40		+105	
Storage Temperature	T _{STG}	-	-50	-	+125	°C

Frequency Stability

PARAMETER	SYMBOL	CONDITIONS	MIN	TYP	MAX	UNIT
Frequency Range						
LVPECL	f ₀	-		80 - 170		MHz
LVDS				80 - 170		
Frequency Stability [Note 2]	Δf/f ₀	-		20, 25, 30, 50 or 100		±ppm
Aging	Δf/f ₂₅	First Year @ +25°C, nominal V _{CC}	-3	-	3	ppm

1.] LVDS output only for +1.8V option.

2.] Inclusive of initial tolerance at time of shipment, changes in supply voltage, load, temperature and 1st year aging.

Output Parameters

PARAMETER	SYMBOL	CONDITIONS	MIN	TYP	MAX	UNIT
Output Type	-	-		LVPECL		-
Output Load	R _L	Terminated to V _{CC} - 2.0V	-	50	-	Ohms
Output Voltage Levels	V _{OH}	PECL Load, -20°C to +70°C	V _{CC} - 1.025	-	V _{CC} - 0.880	V
	V _{OL}		V _{CC} - 1.810	-	V _{CC} - 1.620	
	V _{OH}	PECL Load, -40°C to +85°C	V _{CC} - 1.085	-	V _{CC} - 0.880	V
	V _{OL}		V _{CC} - 1.830	-	V _{CC} - 1.555	
Output Duty Cycle	SYM	@ V _{CC} - 1.3V	45	-	55	%
Rise and Fall Time	T _R , T _F	@ 20%/80% Levels, R _L = 50 Ohms	-	0.3	0.7	ns
LVDS Output Parameters						
Output Type	-	-		LVDS		-
Output Load	R _L	Between Outputs	-	100	-	Ohms
Output Voltage Levels	V _{OH}	LVDS Load	-	1.43	1.60	V
	V _{OL}		0.90	1.10	-	
Output Duty Cycle	SYM	@ 1.25V	45	-	55	%
Differential Output Voltage	V _{OD}	R _L = 100 Ohms	247	330	454	mV
Offset Voltage	V _{OS}	LVDS Load	1.125	1.25	1.375	V
Rise and Fall Time	T _R , T _F	@ 20%/80% Levels, R _L = 100 Ohms	-	0.4	0.7	ns

Electrical Specifications

Performance Data

Phase Noise [typical]

125.00MHz, LVPECL, $V_{CC} = 3.3V$, $T_A = +25^\circ C$

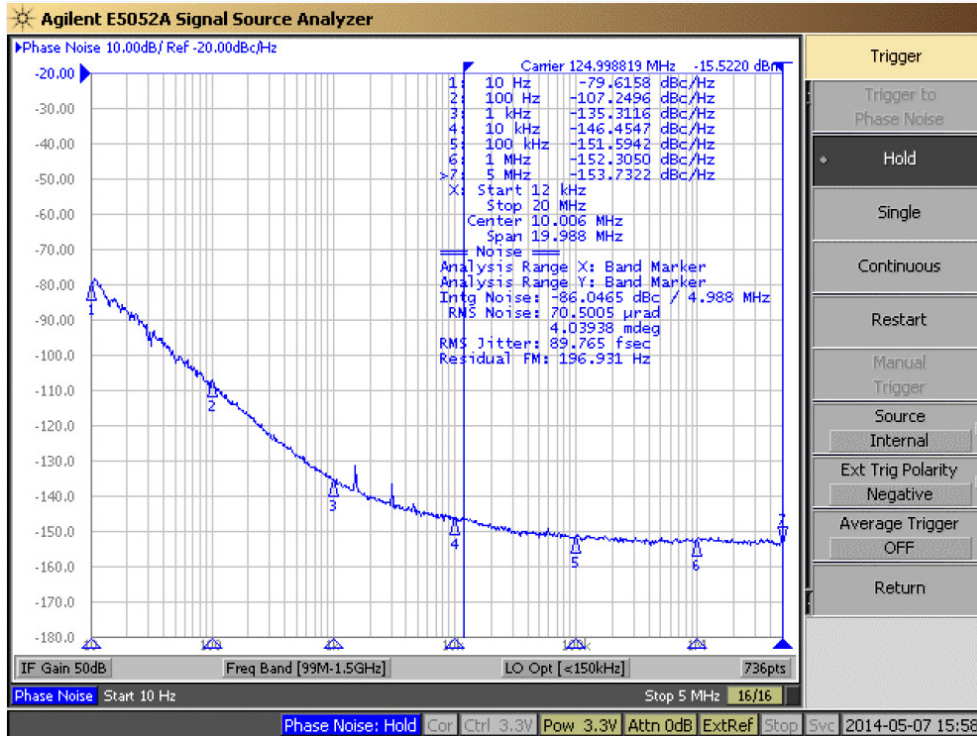

156.25MHz, LVPECL, $V_{CC} = 3.3V$, $T_A = +25^\circ C$

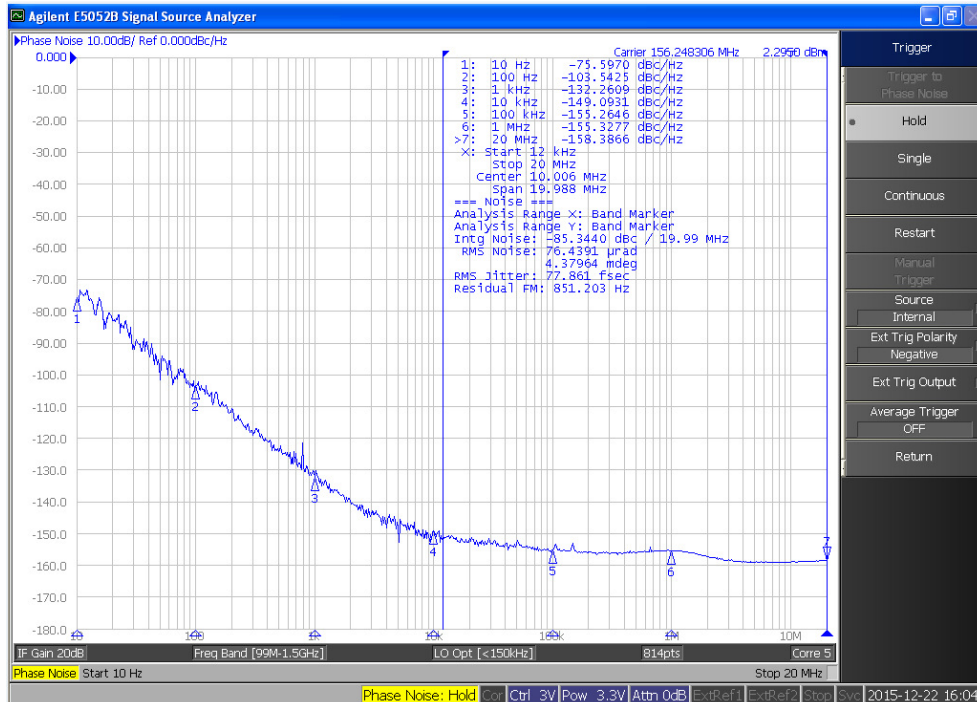

Electrical Specifications

Performance Data

Phase Noise [typical]

156.25MHz, LVDS, $V_{CC} = 3.3V$, $T_A = +25^\circ C$

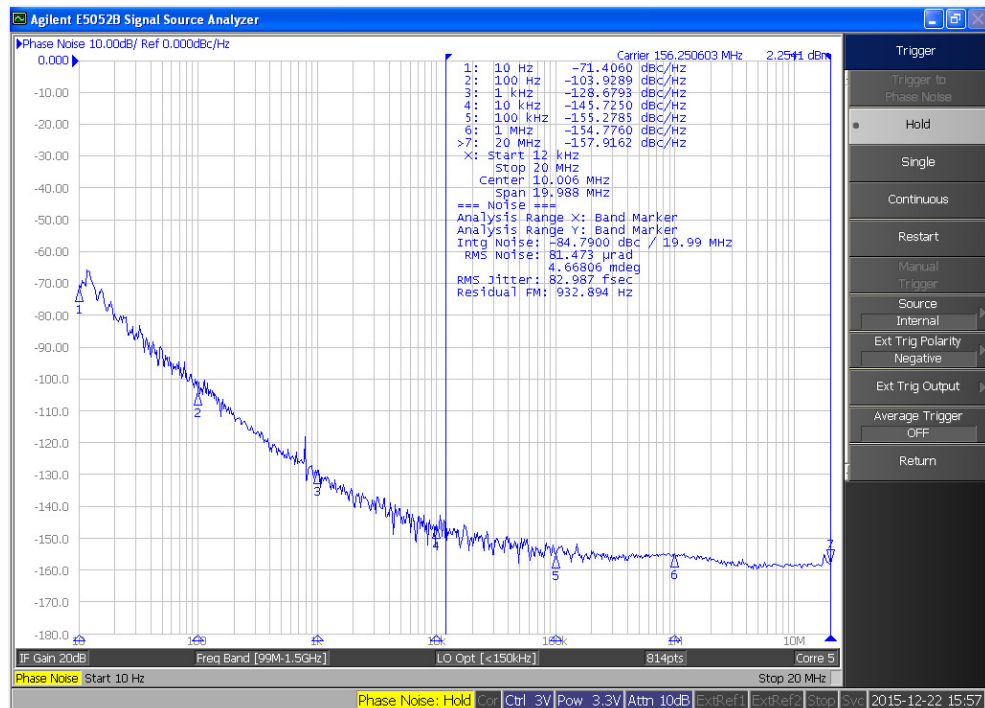

Phase Noise Tabulated

Typical, $V_{CC} = 3.3V$, $T_A = +25^\circ C$

PARAMETER	SYMBOL	CONDITIONS	TYP	UNIT
LVPECL @ 125.00MHz				
Phase Noise		Single Side Band		
		@ 10Hz	-79.62	
		@ 100Hz	-107.25	
		@ 1kHz	-135.31	
		@ 10kHz	-146.45	dBc/Hz
		@ 100kHz	-151.59	
		@ 1MHz	-152.31	
	@ 5MHz	-153.73		
Phase Jitter, RMS	tjrms	Integration Bandwidth 12kHz - 20MHz	89.77	fs

PARAMETER	SYMBOL	CONDITIONS	TYP	UNIT
LVPECL @ 156.25MHz				
Phase Noise		Single Side Band		
		@ 10Hz	-75.60	
		@ 100Hz	-103.54	
		@ 1kHz	-132.26	
		@ 10kHz	-149.09	dBc/Hz
		@ 100kHz	-155.26	
		@ 1MHz	-155.33	
	@ 20MHz	-158.39		
Phase Jitter, RMS	tjrms	Integration Bandwidth 12kHz - 20MHz	77.86	fs

PARAMETER	SYMBOL	CONDITIONS	TYP	UNIT
LVDS @ 156.25MHz				
Phase Noise		Single Side Band		
		@ 10Hz	-71.41	
		@ 100Hz	-103.93	
		@ 1kHz	-128.68	
		@ 10kHz	-145.73	dBc/Hz
		@ 100kHz	-155.28	
		@ 1MHz	-154.78	
	@ 20MHz	-157.92		
Phase Jitter, RMS	tjrms	Integration Bandwidth 12kHz - 20MHz	82.99	fs

Mechanical Specifications

Package Drawing

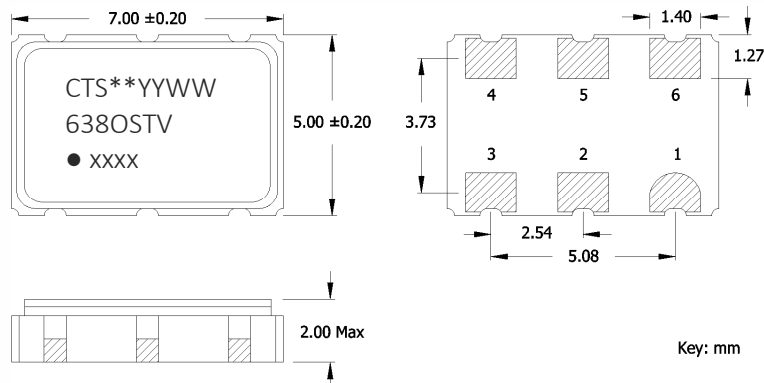

Marking Information

- ** - Manufacturing Site Code.
- YYWW – Date Code; YY – year, WW – week.
- O – Output Type; P or E = LVPECL, L or V = LVDS.
- ST – Frequency Stability/Temperature Code.
[Refer to Ordering Information]
- V – Voltage Code; 3 = 3.3V, 2 = 2.5V.
- xxxx – Frequency Code.
3-digits, frequencies below 100MHz
4-digits, frequencies 100MHz or greater
[See document 016-1454-0, Frequency Code Tables.]

Recommended Pad Layout

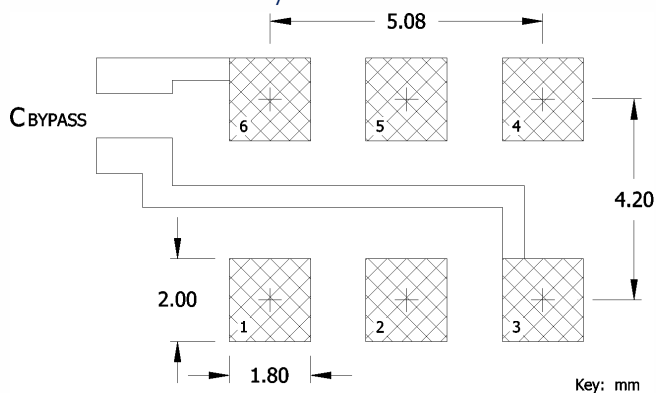

Notes

- JEDEC termination code (e4). Barrier-plating is nickel [Ni] with gold [Au] flash plate.
- Reflow conditions per JEDEC J-STD-020; +260°C maximum, 20 seconds.
- MSL = 1.

Pin Assignments

Pin	Symbol	Function
1	EOH or N.C.	Enable [std] or No Connect
2	N.C. or EOH	No Connect or Enable [opt]
3	GND	Circuit & Package Ground
4	Output	RF Output
5	Output	Complimentary RF Output
6	V _{CC}	Supply Voltage

Packaging - Tape and Reel

Tape Drawing

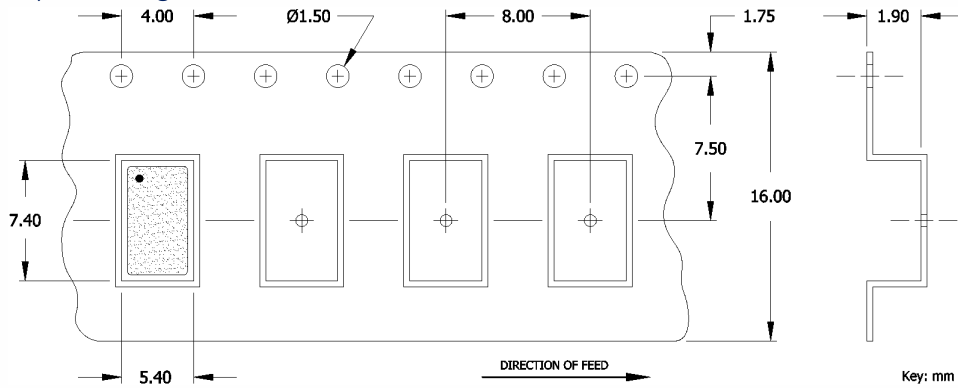

Reel Drawing

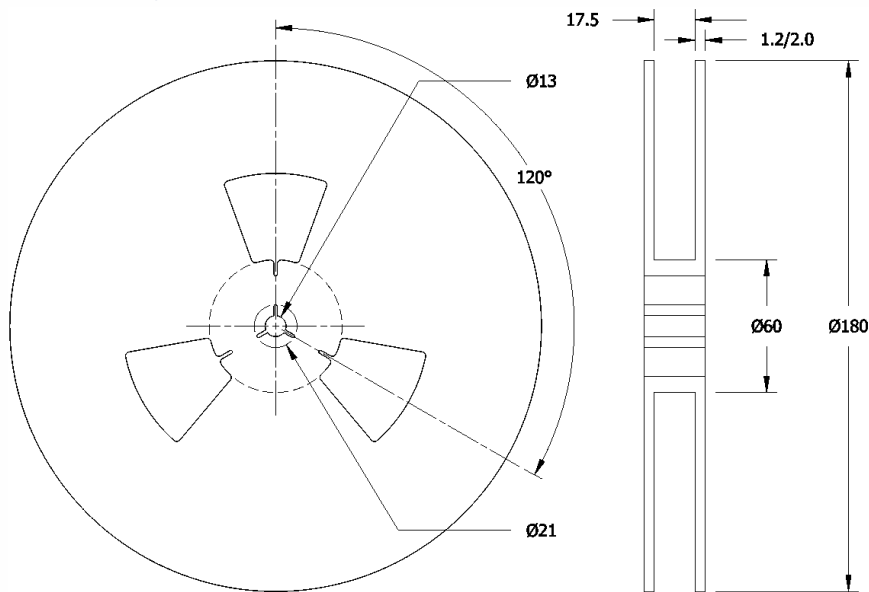

Notes

1. Device quantity is 1k pieces maximum per 180mm reel.
2. Complete CTS part number, frequency value and date code information must appear on reel and carton labels.



Addendum

Common Frequencies Available – MHz

FREQUENCY	FREQUENCY CODE	FREQUENCY	FREQUENCY CODE	FREQUENCY	FREQUENCY CODE	FREQUENCY	FREQUENCY CODE
80.000000	800	156.250000	1562				
100.000000	1000	156.253900	156E				
120.000000	1200	156.253906	156A				
125.000000	1250	161.132800	1611				
133.000000	1330	167.372800	167A				
148.351600	148A						
148.500000	1485						
150.000000	1500						
153.600000	1536						
155.520000	1555						
