

Features

- 2μA Ground Current at no Load
- ±2% Output Accuracy
- 150mA Output Current
- Wide Operating Input Voltage Range: 2V to 20V
- Dropout Voltage: 0.18V at 50mA ($V_{OUT}=5V$)
- Support Fixed Output Voltage
1.8V, 2.5V, 2.8V, 3.0V, 3.3V, 3.6V, 5V
- Stable with Ceramic or Tantalum Capacitor
- Current Limit Protection
- Over-Temperature Protection
- SOT-23-5 Package Available

Applications

- Portable, Battery Powered Equipment
- Low Power Microcontrollers
- Laptop, Palmtops and PDAs
- Wireless Communication Equipment
- Audio/Video Equipment
- Car Navigation Systems
- Industrial Controls
- Weighting Scales
- Meters
- Home Automation

General Description

The Devices is a low-dropout (LDO) voltage regulators with enable function offering the benefits of high input voltage, low-dropout voltage, low-power consumption, and miniaturized packaging.

The features of low quiescent current as low as 2.0μA and zero disable current is ideal for powering the battery equipment to a longer service life. The Devices

is stable with the ceramic output capacitor over its wide input range from 2V to 20V and the entire range of output load current.

Ordering Information

TPMIC5205-5.0YM5

Output voltage: 1.8=1.8V
2.5=2.5V
2.8=2.8V
3.0=3.0V
3.3=3.3V
3.6=3.6V
5.0=5.0V

Marking

TPMIC5205-1.8YM5: KB18
TPMIC5205-2.5YM5: KB25
TPMIC5205-2.8YM5: KB28
TPMIC5205-3.0YM5: KB30
TPMIC5205-3.3YM5: KB33
TPMIC5205-3.6YM5: KB36
TPMIC5205-5.0YM5: KB50

PIN CONFIGURATION

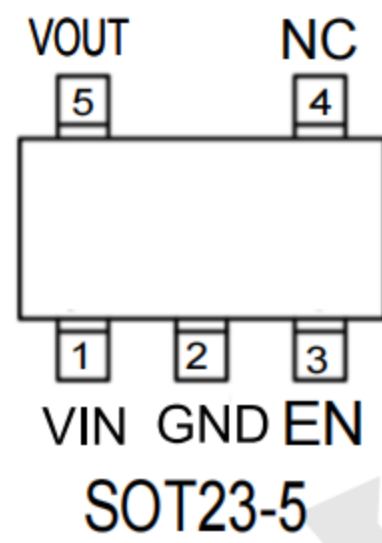

Pin No	Pin Name	Pin Function
1	VIN	Input of Supply Voltage.
2	GND	Ground
3	EN	Enable Control Input.
4	NC	No Internal Connection.
5	VOUT	Output of the Regulator

BLOCK DIAGRAM

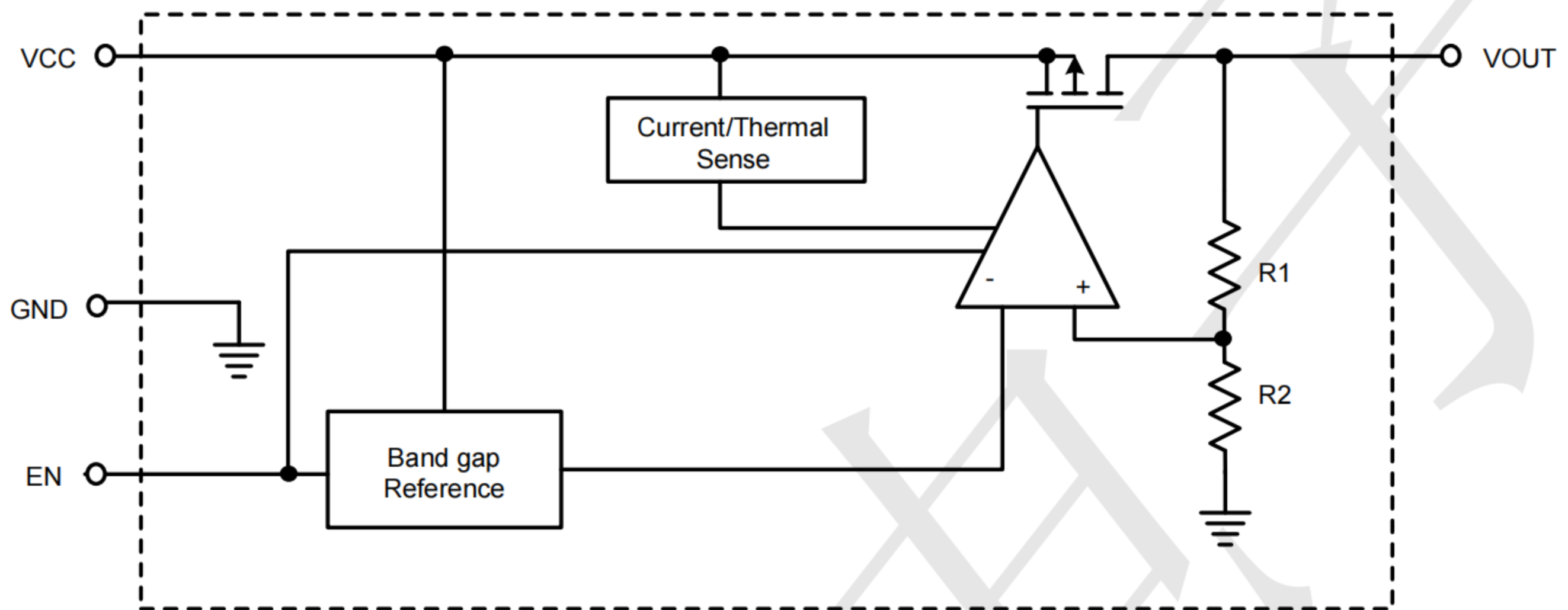

Absolute Maximum Ratings

VIN Pin to GND Pin Voltage	-0.3V to 24V
VOUT Pin to GND Pin Voltage	-0.3V to 6.0V
VOUT Pin to VIN Pin Voltage	-24V to 0.3V
Package Thermal Resistance (Note 2)	
SOT-23-5, SOT-23-3, θ_{JA}	200 °C /W
Lead Temperature (Soldering, 10 sec.)	260 °C
Junction Temperature	150 °C
Storage Temperature Range	-40 °C to 150 °C
ESD Susceptibility	
HBM	2KV
MM	200V

Recommended Operating Conditions

Supply Input Voltage	-2.0V to 20V
Junction Temperature Range	-40°C to 125°C
Ambient Temperature Range	-40°C to 85°C

Electrical Characteristics

($V_{IN}=15V$, $V_{EN}=5V$, $T_A=25^{\circ}C$, unless otherwise specified) (Note 1)

Parameter	Symbol	Test Conditions	Min	Typ	Max	Unit
Supply Voltage	V_{IN}		2	--	20	V
DC Output Voltage Accuracy		$I_{LOAD} = 0.1mA$	-2		2	%
Dropout Voltage ($I_{LOAD} = 50mA$)	V_{DROP}	$V_{OUT} \geq 5V$	--	0.18		V
	$V_{DROP_3.3V}$	$V_{OUT} = 3.3V$		0.2		
	$V_{DROP_1.8V}$	$V_{OUT} = 1.8V$		0.25		
Ground Current ($I_{LOAD} = 0mA$)	I_Q	$V_{OUT} \leq 5V$		2.0	4.5	μA
Shutdown Ground Current	I_{SD}	$V_{EN} = 0V$, $V_{OUT} = 0V$		0.01	0.5	μA
V_{OUT} Shutdown Leakage Current	I_{LEAK}			0.01	0.5	μA
Enable Threshold Voltage	V_{IH}	EN Rising	1.1			V
	V_{IL}	EN Falling			0.4	
EN Input Current	I_{EN}	$V_{EN} = 27V$		10	100	nA
Line Regulation	Δ_{LINE}	$I_{LOAD} = 1mA$, $10 \leq V_{IN} \leq 20V$	--	0.3		%
Load Regulation	Δ_{LOAD}	$10mA \leq I_{LOAD} \leq 0.2A$		0.3		%
Output Current Limit	I_{LIM}	$V_{OUT} = 0$	150			mA
Power Supply Rejection Ratio	PSRR	$V_{OUT} = 5V$, $I_{LOAD} = 30mA$, $V_{IN} = 12V$, $f = 1kHz$		70		dB
Thermal Shutdown Temperature	T_{SD}	$I_{LOAD} = 10mA$	--	160	--	$^{\circ}C$
Thermal Shutdown Hysteresis	ΔT_{SD}			15		$^{\circ}C$

Typical Application Circuit

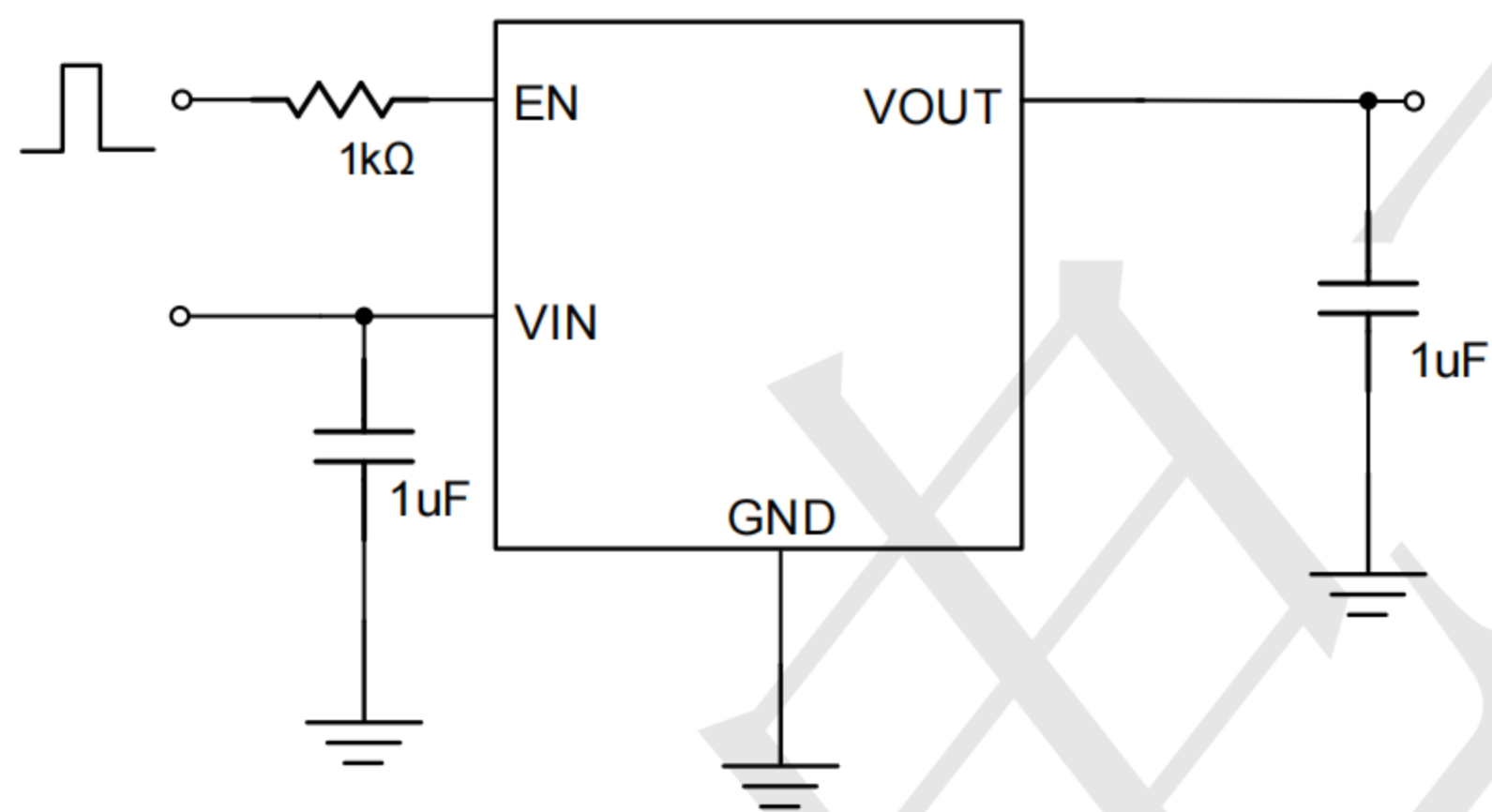
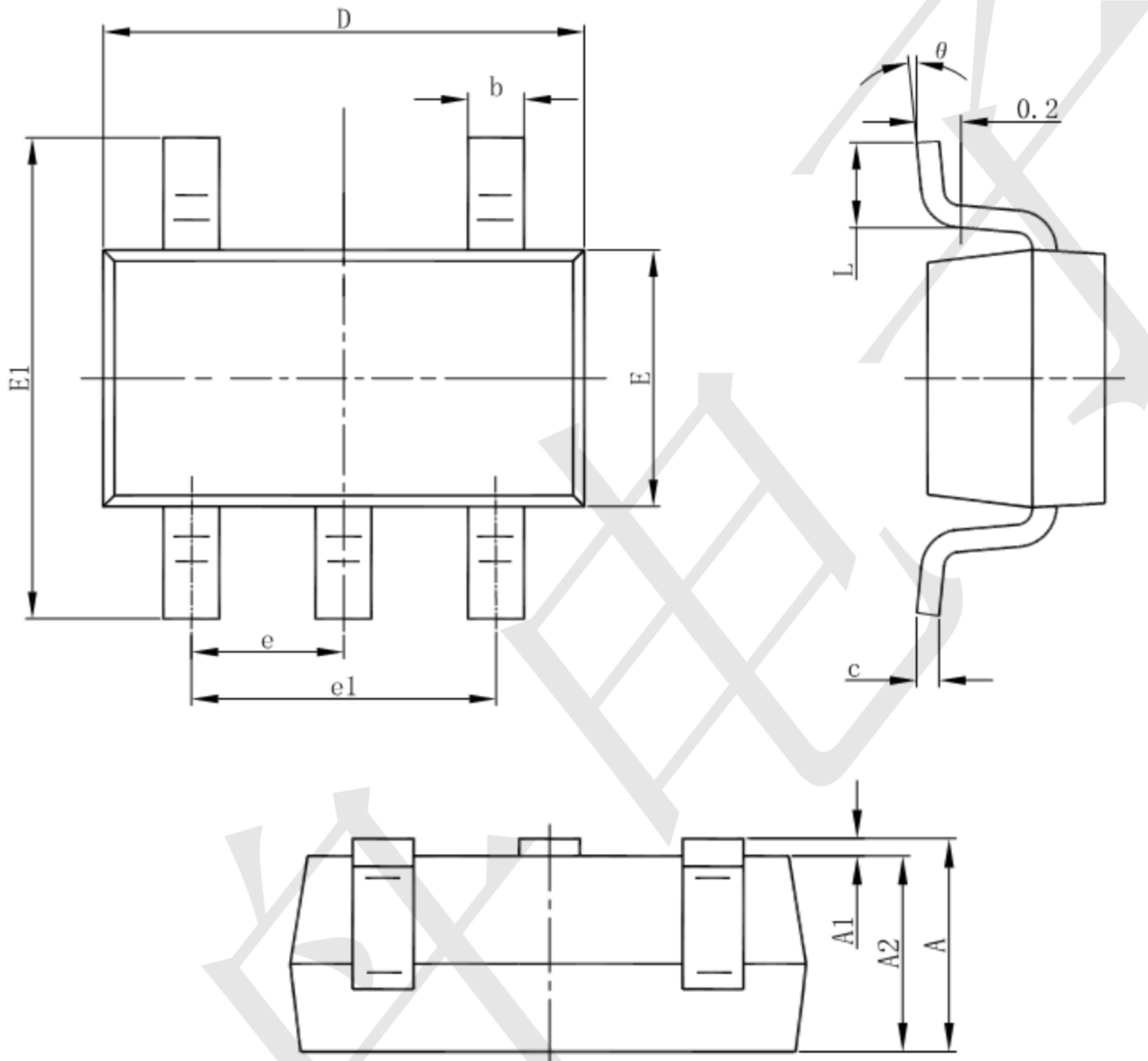

Figure 1: Application circuit of Fixed VOUT LDO with enable function



Package informantion

SOT23-5



Symbol	Dimensions In Millimeters		Dimensions In Inches	
	Min	Max	Min	Max
A	1.050	1.250	0.041	0.049
A1	0.000	0.100	0.000	0.004
A2	1.050	1.150	0.041	0.045
b	0.300	0.500	0.012	0.020
c	0.100	0.200	0.004	0.008
D	2.820	3.020	0.111	0.119
E	1.500	1.700	0.059	0.067
E1	2.650	2.950	0.104	0.116
e	0.950(BSC)		0.037(BSC)	
e1	1.800	2.000	0.071	0.079
L	0.300	0.600	0.012	0.024
theta	0°	8°	0°	8°