

REVISIONS				
REV.	ECO. NO	DESCRIPTION	DATE	BY
D	3780	ADD DEFAULT MATERIAL COLOR, ADD S328 FOR BROWN PPS OPTION	12/15/2017	JH
E	4435	ADD MOLDED KEY OPTION	09/21/2021	PL

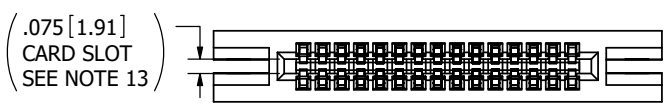

--- C --- FSLQ  
 --- C --- FSLQ-S328

- NOTES:
- INSULATOR MATERIAL: SEE PART NUMBER CODING
  - CONTACT MATERIAL: SEE PART NUMBER CODING
  - PLATING: SEE PART NUMBER CODING
  - OPERATING TEMPERATURE: SEE PART NUMBER CODING
  - UL FLAMMABILITY RATING: 94V-0
  - DIELECTRIC WITHSTANDING VOLTAGE: 1125 VAC
  - CURRENT RATING: 3 AMP
  - CONTACT RESISTANCE: 30 MILLI OHMS MAX
  - INSULATION RESISTANCE: 5000 MEGA OHMS
  - DURABILITY: 500 CYCLES MINIMUM
  - CONNECTOR IDENTIFICATION: THE PART SHALL BE MARKED WITH A PART NUMBER AND LOT CODE
  - BOARD THICKNESS ACCOMMODATED: .062 ± .008 [1.57 ± 0.20]
  - INSERTION FORCE: 8 OZ MAX PER CONTACT PAIR WHEN USING A .062 [1.57] TEST BLADE
  - INTERNAL INSPECTION TO BE PER SULLINS WORK INSTRUCTION WI-8.6-03
  - WITHDRAWAL FORCE: 1 OZ MIN PER CONTACT PAIR USING .062 [1.57] TEST BLADE
  - MODIFICATION: SEE PART NUMBER CODING

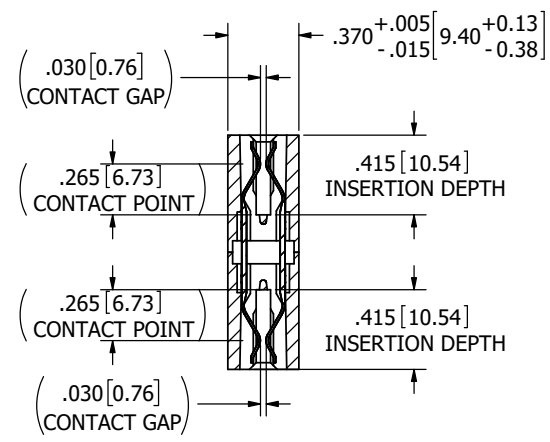
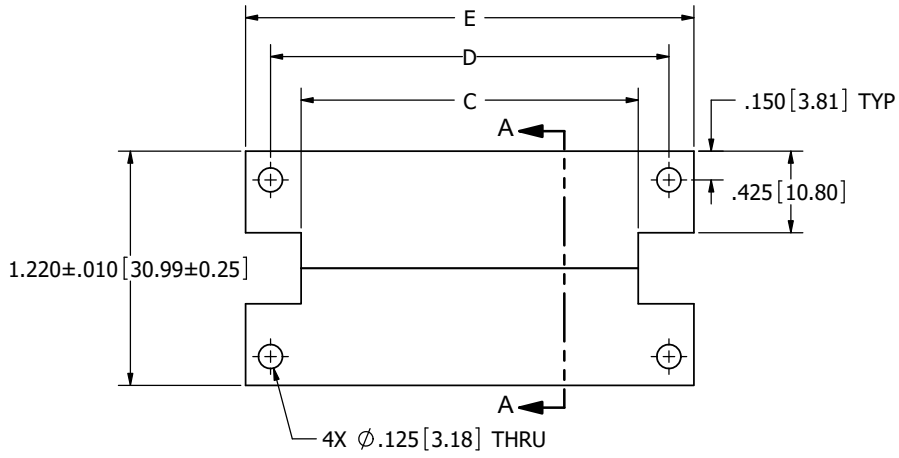
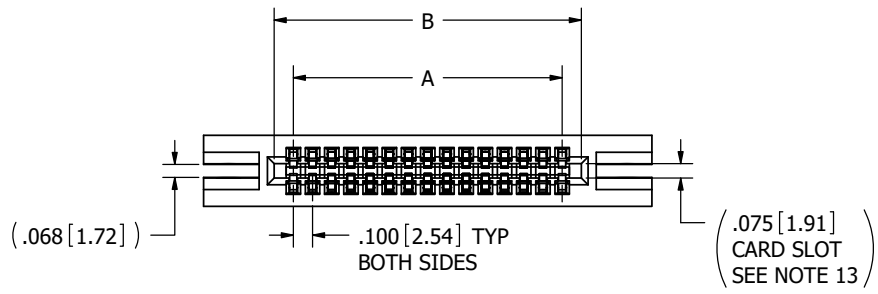
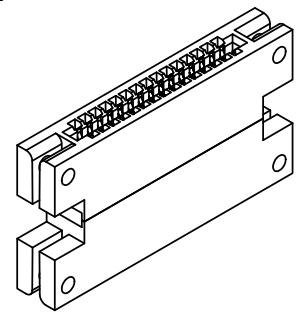

**CUSTOMER COPY**



UNLESS OTHERWISE SPECIFIED, DIMENSIONS ARE IN INCHES [MM]	DRAWN	DATE	NAME	
		5/26/11	MNH	
TOLERANCES:	<small>THE INFORMATION HEREIN CONTAINS PROPRIETARY INFORMATION OF SULLINS ELECTRONICS AND IS NOT TO BE REPRODUCED, USED OR DISCLOSED TO OTHERS FOR ANY PURPOSE EXCEPT AS SPECIFICALLY AUTHORIZED IN WRITING BY AN OFFICER OF SULLINS ELECTRONICS.</small>			
ANGULAR: ± 1°	TITLE <b>DUAL-EDGE .100" PITCH CONNECTOR</b>			
DECIMALS .XX = ± .02 [5] .XXX = ± .005 [13] .XXXX = ± .0005 [13]	PART NUMBER <b>--- C --- FSL (-S328)</b>			
	SIZE	CAGE CODE	DWG. NO.	REV
	C	54453	C10823	E
	SCALE: 2:1	SHEET 1 OF 3		

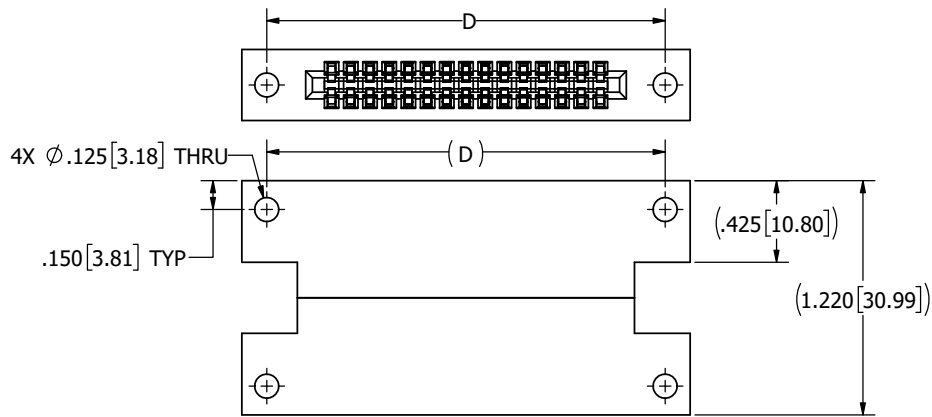

--- C --- FSLZ  
--- C --- FSLZ-S328

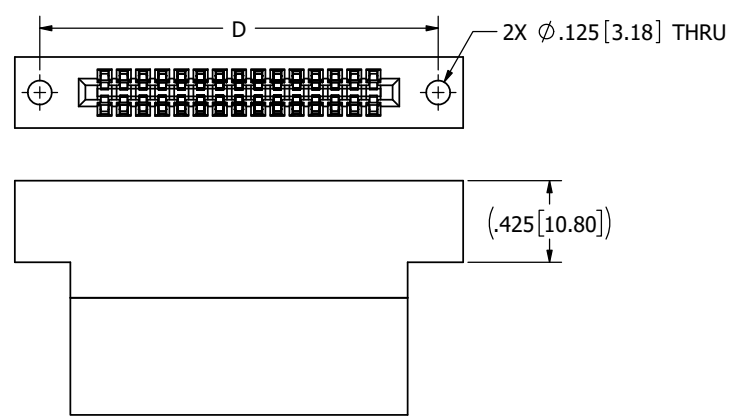

--- C --- FSLD  
--- C --- FSLD-S328

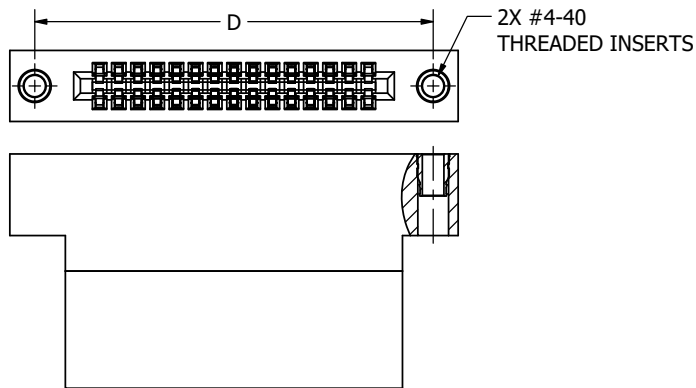

--- C --- FSLI  
--- C --- FSLI-S328

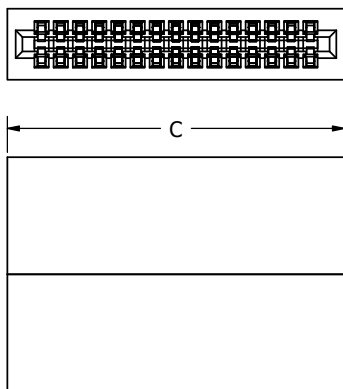

--- C --- FSLN  
--- C --- FSLN-S328

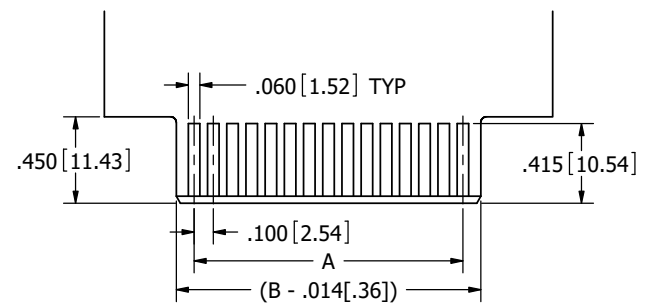

PCB LAYOUT RECOMMENDED 'N', 'D', 'Z', & 'I' MOUNTING

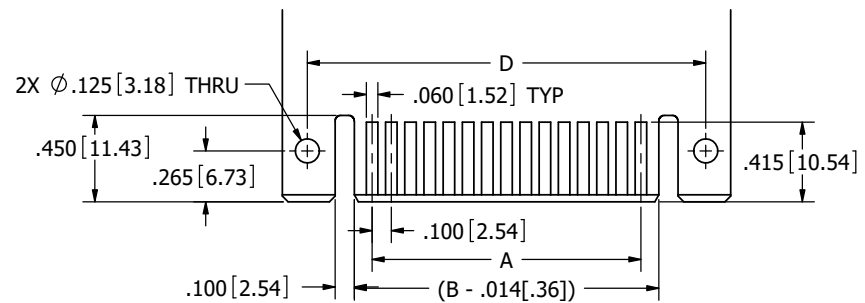

PCB LAYOUT RECOMMENDED 'Q' MOUNTING

# CUSTOMER COPY



RoHS COMPLIANT

UNLESS OTHERWISE SPECIFIED: DIMENSIONS ARE IN INCHES [MM]		DRAWN	DATE	NAME		
TOLERANCES: ANGULAR: ± 1° DECIMALS .XX = ± .02 [5] .XXX = ± .005 [13] .XXXX = ± .0005 [013]			5/26/11	MNH		TITLE <b>DUAL-EDGE .100" PITCH CONNECTOR</b> PART NUMBER --- C --- FSL (-S328)
THE INFORMATION HEREIN CONTAINS PROPRIETARY INFORMATION OF SULLINS ELECTRONICS AND IS NOT TO BE REPRODUCED, USED OR DISCLOSED TO OTHERS FOR ANY PURPOSE EXCEPT AS SPECIFICALLY AUTHORIZED IN WRITING BY AN OFFICER OF SULLINS ELECTRONICS.			SIZE <b>C</b>	CAGE CODE <b>54453</b>	DWG. NO. <b>C10823</b>	REV <b>E</b>
SCALE: 2:1		SHEET 2 OF 3				

PART NUMBER	NO. OF POSITIONS	A±.008[0.20]		B±.008[0.20]		C±.015[0.38]		D±.010[0.25]		E±.020[0.25]	
		INCH	MM	INCH	MM	INCH	MM	INCH	MM	INCH	MM
C02FSL	2	0.100	2.54	0.300	7.62	0.456	11.58	0.775	19.69	1.035	26.29
C05FSL	5	0.400	10.16	0.600	15.24	0.756	19.20	1.075	27.31	1.335	33.91
C06FSL	6	0.500	12.70	0.700	17.78	0.856	21.74	1.175	29.85	1.435	36.45
C07FSL	7	0.600	15.24	0.800	20.32	0.956	24.28	1.275	32.39	1.535	38.99
C08FSL	8	0.700	17.78	0.900	22.86	1.056	26.82	1.375	34.93	1.635	41.53
C09FSL	9	0.800	20.32	1.000	25.40	1.156	29.36	1.475	37.47	1.735	44.07
C10FSL	10	0.900	22.86	1.100	27.94	1.256	31.90	1.575	40.01	1.835	46.61
C11FSL	11	1.000	25.40	1.200	30.48	1.356	34.44	1.675	42.55	1.935	49.15
C12FSL	12	1.100	27.94	1.300	33.02	1.456	36.98	1.775	45.09	2.035	51.69
C13FSL	13	1.200	30.48	1.400	35.56	1.556	39.52	1.875	47.63	2.135	54.23
C14FSL	14	1.300	33.02	1.500	38.10	1.656	42.06	1.975	50.17	2.235	56.77
C15FSL	15	1.400	35.56	1.600	40.64	1.756	44.60	2.075	52.71	2.335	59.31
C16FSL	16	1.500	38.10	1.700	43.18	1.856	47.14	2.175	55.25	2.435	61.85
C17FSL	17	1.600	40.64	1.800	45.72	1.956	49.68	2.275	57.79	2.535	64.39
C18FSL	18	1.700	43.18	1.900	48.26	2.056	52.22	2.375	60.33	2.635	66.93
C19FSL	19	1.800	45.72	2.000	50.80	2.156	54.76	2.475	62.87	2.735	69.47
C20FSL	20	1.900	48.26	2.100	53.34	2.256	57.30	2.575	65.41	2.835	72.01
C21FSL	21	2.000	50.80	2.200	55.88	2.356	59.84	2.675	67.95	2.935	74.55
C22FSL	22	2.100	53.34	2.300	58.42	2.456	62.38	2.775	70.49	3.035	77.09
C23FSL	23	2.200	55.88	2.400	60.96	2.556	64.92	2.875	73.03	3.135	79.63
C24FSL	24	2.300	58.42	2.500	63.50	2.656	67.46	2.975	75.57	3.235	82.17
C25FSL	25	2.400	60.96	2.600	66.04	2.756	70.00	3.075	78.11	3.335	84.71
C26FSL	26	2.500	63.50	2.700	68.58	2.856	72.54	3.175	80.65	3.435	87.25
C27FSL	27	2.600	66.04	2.800	71.12	2.956	75.08	3.275	83.19	3.535	89.79
C28FSL	28	2.700	68.58	2.900	73.66	3.056	77.62	3.375	85.73	3.635	92.33
C29FSL	29	2.800	71.12	3.000	76.20	3.156	80.16	3.475	88.27	3.735	94.87
C30FSL	30	2.900	73.66	3.100	78.74	3.256	82.70	3.575	90.81	3.835	97.41
C31FSL	31	3.000	76.20	3.200	81.28	3.356	85.24	3.675	93.35	3.935	99.95
C32FSL	32	3.100	78.74	3.300	83.82	3.456	87.78	3.775	95.89	4.035	102.49
C33FSL	33	3.200	81.28	3.400	86.36	3.556	90.32	3.875	98.43	4.135	105.03
C34FSL	34	3.300	83.82	3.500	88.90	3.656	92.86	3.975	100.97	4.235	107.57
C35FSL	35	3.400	86.36	3.600	91.44	3.756	95.40	4.075	103.51	4.335	110.11
C36FSL	36	3.500	88.90	3.700	93.98	3.856	97.94	4.175	106.05	4.435	112.65
C37FSL	37	3.600	91.44	3.800	96.52	3.956	100.48	4.275	108.59	4.535	115.19
C38FSL	38	3.700	93.98	3.900	99.06	4.056	103.02	4.375	111.13	4.635	117.73
C39FSL	39	3.800	96.52	4.000	101.60	4.156	105.56	4.475	113.67	4.735	120.27
C40FSL	40	3.900	99.06	4.100	104.14	4.256	108.10	4.575	116.21	4.835	122.81
C41FSL	41	4.000	101.60	4.200	106.68	4.356	110.64	4.675	118.75	4.935	125.35
C42FSL	42	4.100	104.14	4.300	109.22	4.456	113.18	4.775	121.29	5.035	127.89
C43FSL	43	4.200	106.68	4.400	111.76	4.556	115.72	4.875	123.83	5.135	130.43
C44FSL	44	4.300	109.22	4.500	114.30	4.656	118.26	4.975	126.37	5.235	132.97
C45FSL	45	4.400	111.76	4.600	116.84	4.756	120.80	5.075	128.91	5.335	135.51
C46FSL	46	4.500	114.30	4.700	119.38	4.856	123.34	5.175	131.45	5.435	138.05
C47FSL	47	4.600	116.84	4.800	121.92	4.956	125.88	5.275	133.99	5.535	140.59
C48FSL	48	4.700	119.38	4.900	124.46	5.056	128.42	5.375	136.53	5.635	143.13
C49FSL	49	4.800	121.92	5.000	127.00	5.156	130.96	5.475	139.07	5.735	145.67
C50FSL	50	4.900	124.46	5.100	129.54	5.256	133.50	5.575	141.61	5.835	148.21
C51FSL	51	5.000	127.00	5.200	132.08	5.356	136.04	5.675	144.15	5.935	150.75
C52FSL	52	5.100	129.54	5.300	134.62	5.456	138.58	5.775	146.69	6.035	153.29
C53FSL	53	5.200	132.08	5.400	137.16	5.556	141.12	5.875	149.23	6.135	155.83
C54FSL	54	5.300	134.62	5.500	139.70	5.656	143.66	5.975	151.77	6.235	158.37
C55FSL	55	5.400	137.16	5.600	142.24	5.756	146.20	6.075	154.31	6.335	160.91
C56FSL	56	5.500	139.70	5.700	144.78	5.856	148.74	6.175	156.85	6.435	163.45
C57FSL	57	5.600	142.24	5.800	147.32	5.956	151.28	6.275	159.39	6.535	165.99
C58FSL	58	5.700	144.78	5.900	149.86	6.056	153.82	6.375	161.93	6.635	168.53
C59FSL	59	5.800	147.32	6.000	152.40	6.156	156.36	6.475	164.47	6.735	171.07
C60FSL	60	5.900	149.86	6.100	154.94	6.256	158.90	6.575	167.01	6.835	173.61
C70FSL	70	6.900	175.26	7.100	180.34	7.256	184.30	7.575	192.41	7.835	199.01

### PART NUMBER CODING

#### MATERIALS (INSULATOR / CONTACT)

**E = BLACK PBT/PHOSPHOR BRONZE**  
OPERATING TEMP: -65°C TO +125°C

**R = BLACK PPS/PHOSPHOR BRONZE**  
OPERATING TEMP: -65°C TO +125°C

**H = BLACK PBT/BERYLLIUM COPPER**  
OPERATING TEMP: -65°C TO +125°C

**A = BLACK PPS/BERYLLIUM COPPER**  
OPERATING TEMP: -65°C TO +150°C

#### PLATING

ALL PLATINGS HAVE .000100" NICKEL UNDERPLATE OVERALL

CONTACT SURFACE BOTH SIDES

A = .000030" GOLD

#### MODIFICATION CODE

OMIT FOR STANDARD, EX: 'EAC06FSLD'  
S328 = BROWN PPS (MATERIAL CODE 'R' OR 'A' ONLY)  
OTHER S# FOR MOLDED KEY OPTION  
(SEE DRAWING C13556 FOR S#, G & H DIMENSIONS)

#### MOUNTING STYLE

Q = STRADDLE MOUNT  
D = .125 MOUNTING HOLES  
N = NO MOUNTING  
I = #4-40 THREADED INSERT  
Z = SIDE MOUNTING

#### NUMBER OF POSITIONS

(CONTACTS PER ROW)

### KEY IN POSITION

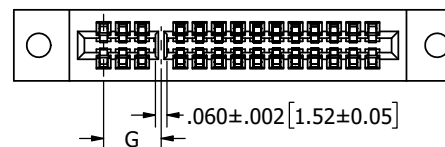

### KEY BETWEEN POSITIONS

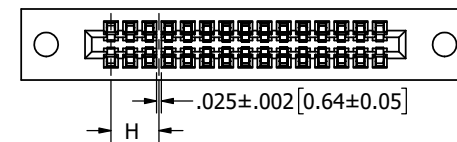

(‘D’ MOUNTING AS SHOWN FOR EXAMPLE)

## CUSTOMER COPY



UNLESS OTHERWISE SPECIFIED:  
DIMENSIONS ARE IN INCHES (MM)

TOLERANCES:  
ANGULAR: ± 1°  
DECIMALS  
XX = ± .02 [5]  
XXX = ± .005 [13]  
XXXX = ± .0005 [013]

DRAWN: 5/26/11  
DATE: 5/26/11  
NAME: MNH  
THE INFORMATION HEREIN CONTAINS PROPRIETARY INFORMATION OF SULLINS ELECTRONICS AND IS NOT TO BE REPRODUCED, USED OR DISCLOSED TO OTHERS FOR ANY PURPOSE EXCEPT AS SPECIFICALLY AUTHORIZED IN WRITING BY AN OFFICER OF SULLINS ELECTRONICS.

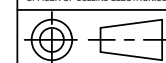

TITLE: DUAL-EDGE .100" PITCH CONNECTOR

PART NUMBER: C\_FSL (-S328)

SIZE: C CAGE CODE: 54453 DWG. NO.: C10823 REV: E  
SCALE: 2:1 SHEET 3 OF 3