

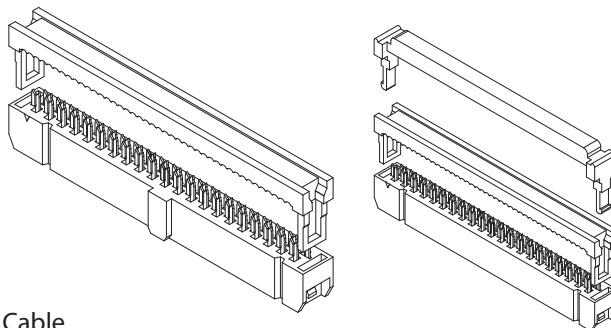

.100" [2.54 mm] Contact Centers, IDC Socket, Insulation Displacement- SFH Series With or Without Strain Relief Mates with SBH11 series

SPECIFICATIONS

- Centered Polarizing Key Optional
- Operating Temperature: -40°C to +105°C
- UL Flammability Rating: 94V-0
- Current Rating: 1 Amp
- Dielectric Withstanding: 500 VAC
- Insulation Resistance: 3,000 Megohms
- For .050" [1.27 mm] Pitch AWG 26-28 Flat Ribbon Cable



PART NUMBER OPTIONS

SFH210 - P P P C - D 10 - ID - BK - Mxxx

SERIES

- SFH210 = IDC Socket, Without Strain Relief
- SFH213 = IDC Socket, With Strain Relief

INSULATOR MATERIAL

P = PBT

CONTACT MATERIAL

P = Phosphor Bronze

CONTACT FINISH - RoHS Compliant

- P = Gold Flash Overall
- E = .000100" Pure Tin, Matte, Overall
- V = Gold Flash on Contact Surface, Nickel on Termination
- J = .000015" Gold on Contact Surface, Gold Flash on Termination
- K = .000015" Gold on Contact Surface, Nickel on Termination

MODIFICATION (Omit for Standard)

- M181 = Without Centered Polarizing Key
- M207 = With Polarizing Key, With Mylar in Tape & Reel (only for SFH210)
- M208 = Without Polarizing Key, With Mylar in Tape and Reel (only for SFH210)

COLOR

BK = Black

TERMINATION TYPE

ID = Insulation Displacement

NUMBER OF CONTACT POSITIONS

03 thru 13, 15, 17, 20, 25, 30, 32

*M208 and M207 not available in 30 or 32

NUMBER OF ROWS

D = Dual Row

CONTACT CENTERS

C = .100" [2.54 mm]

DIMENSIONS For complete drawings, go to www.sullinscorp.com or e-mail techsupport@sullinscorp.com

Dimensions in [] are in millimeters, all others are in inches.

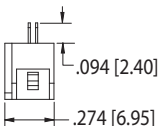
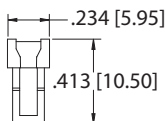

INSULATION DISPLACEMENT (ID) without Strain Relief requires SFH210

Example P/N: SFH210-PPPC-D03-ID-BK

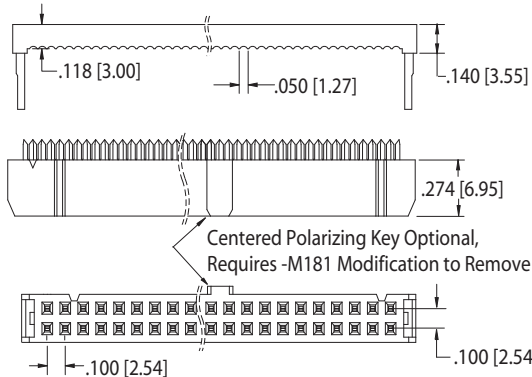

Centered Polarizing Key Optional, Requires -M181 Modification to Remove

-M181 Modification (No Centered Polarizing Key)

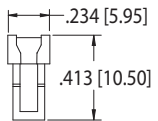
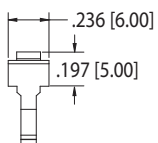
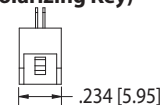

INSULATION DISPLACEMENT (ID) with Strain Relief requires SFH213

Example P/N: SFH213-PPPC-D03-ID-BK

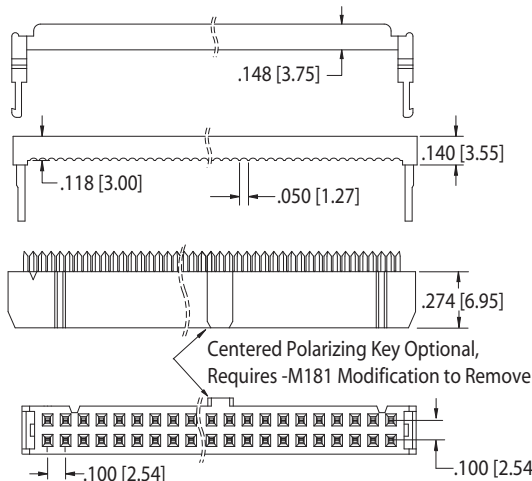

Centered Polarizing Key Optional, Requires -M181 Modification to Remove

-M181 Modification (No Centered Polarizing Key)

