

| | | | | |
|----------|---------------|------------------|-----------|-----------|
| 版次 (REV) | 变更编号 (ECN NO) | 说明 (DESCRIPTION) | 日期 (DATE) | 核准 (APPD) |
| X1 | | 初版发行 | | |
| | | | | |

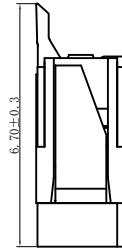

新料号 1025A0-***-***

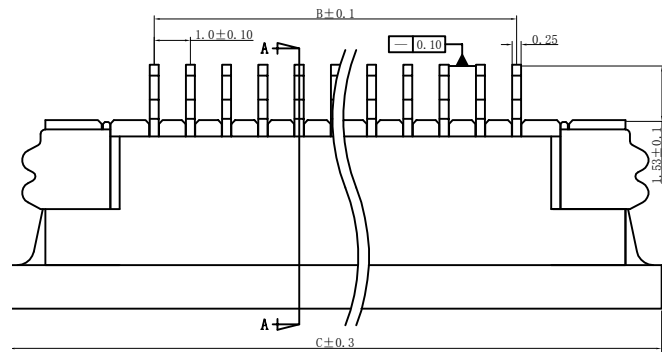
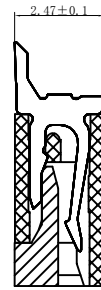

PIN数
 1: LCP 2: PA9T
 D: 袋装 G: 管装 P: 盘装
 1: 雾锡 2: 亮锡 3: 镀金

旧料号 88353-XXX-XX-XX
 PIN数
 电镀: 1镀金 2镀雾锡 3镀亮锡
 包材: A管装 B袋装 C盒装 D卷装

| NO | 胶体材质 | 锁扣材质 | 胶体颜色 | 锁扣颜色 | 柱子 |
|----|------|------|------|------|----|
| 1 | LCP | LCP | 本色 | 黑色 | |
| 2 | PA9T | LCP | 本色 | 黑色 | |

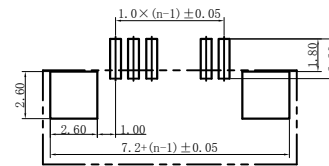
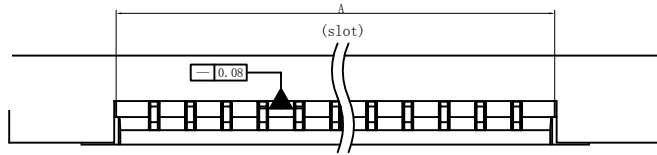

PC BOARD LAYOUT

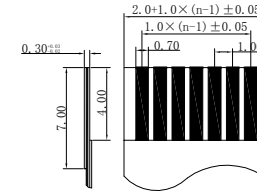

| NO. of Contacts (n) | Dimensions | | |
|---------------------|------------|------|------|
| | A | B | C |
| 004 | 5.1 | 3.0 | 11.0 |
| 005 | 6.1 | 4.0 | 12.0 |
| 006 | 7.1 | 5.0 | 13.0 |
| 007 | 8.1 | 6.0 | 14.0 |
| 008 | 9.1 | 7.0 | 15.0 |
| 009 | 10.1 | 8.0 | 16.0 |
| 010 | 11.1 | 9.0 | 17.0 |
| 011 | 12.1 | 10.0 | 18.0 |
| 012 | 13.1 | 11.0 | 19.0 |
| 013 | 14.1 | 12.0 | 20.0 |
| 014 | 15.1 | 13.0 | 21.0 |
| 015 | 16.1 | 14.0 | 22.0 |
| 016 | 17.1 | 15.0 | 23.0 |
| 017 | 18.1 | 16.0 | 24.0 |
| 018 | 19.1 | 17.0 | 25.0 |
| 019 | 20.1 | 18.0 | 26.0 |
| 020 | 21.1 | 19.0 | 27.0 |
| 021 | 22.1 | 20.0 | 28.0 |
| 022 | 23.1 | 21.0 | 29.0 |
| 023 | 24.1 | 22.0 | 30.0 |
| 024 | 25.1 | 23.0 | 31.0 |
| 025 | 26.1 | 24.0 | 32.0 |
| 026 | 27.1 | 25.0 | 33.0 |
| 027 | 28.1 | 26.0 | 34.0 |
| 028 | 29.1 | 27.0 | 35.0 |
| 029 | 30.1 | 28.0 | 36.0 |
| 030 | 31.1 | 29.0 | 37.0 |
| 031 | 32.1 | 30.0 | 38.0 |
| 032 | 33.1 | 31.0 | 39.0 |

Electrical

Voltage: 50 V AC(rms)/DC
 Current: 0.5 A AC(rms)/DC
 Contact Resistance: 40 mΩ max(initial)
 Dielectric Withstanding Voltage: 200 V AC/rms
 Insulation Resistance: 500 MΩ min
 Operating Temp: -25° C ~ +85° C

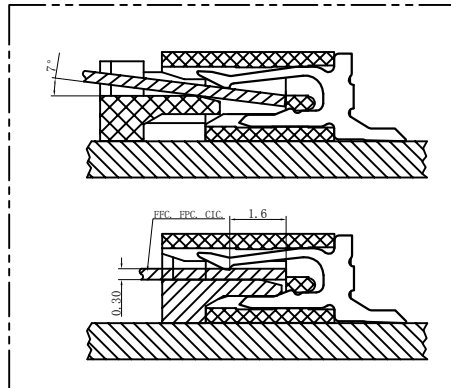

| | | | | | |
|-------------------|---------|-----------------------|-----------|--------------|------------|
| 使用类别 (EXTEND USE) | | 品名 (TITLE) | | 博穆电子有限公司 | |
| FPC1.0拉拔式半包上接 | | FPC1.0拉拔式半包上接 客户图面 | | | |
| 尺寸公差 | | 原材料 (MATERIAL) | 核准 (APPD) | 图号 (DWG NO): | |
| DIMENTION | | 数量 (QTY) | 审核 (CHD) | 1025A0 | |
| . ±0.30 | 角度公差 | 表面处理 (FINISHED) | 绘图 (DRN) | 料号 (P/N): | |
| .0 ±0.20 | ANGLES | 安路路 2011.6.23 | | 页数 (SHEET) | 比例 (SCALE) |
| .00 ±0.10 | . ±3° | | | 1/1 | 1:1 |
| .000 ±0.05 | .0 ±2° | | | | |
| | .00 ±1° | | | | |