

- ★ Green Device Available
- ★ Super Low Gate Charge
- ★ Excellent CdV/dt effect decline
- ★ Advanced high cell density Trench technology

Product Summary



BVDSS	RDS(on)	ID
60V	75mΩ	3A

Description

The 6003 is the high cell density trenched N-ch MOSFETs, which provides excellent RDS(on) and efficiency for most of the small power switching and load switch applications. The 6003 meets the RoHS and Green Product requirement with full function reliability approved.

SOT23 Pin Configuration

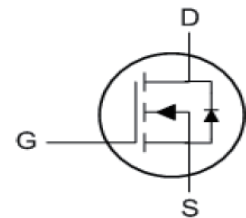
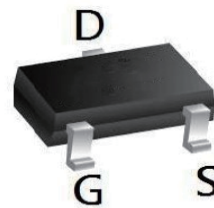

Absolute Maximum Ratings

Symbol	Parameter	Max.	Units
V <sub>DSS</sub>	Drain-Source Voltage	60	V
V <sub>GSS</sub>	Gate-Source Voltage	±20	V
I <sub>D</sub>	Continuous Drain Current	T <sub>A</sub> = 25°C	3 A
		T <sub>A</sub> = 100°C	2 A
I <sub>DM</sub>	Pulsed Drain Current <small>note1</small>	12	A
P <sub>D</sub>	Power Dissipation	T <sub>A</sub> = 25°C	1.5 W
R <sub>θJA</sub>	Thermal Resistance, Junction to Ambient	83	°C/W
T <sub>J</sub> , T <sub>STG</sub>	Operating and Storage Temperature Range	-55 to +150	°C

**Electrical Characteristics ( $T_J = 25^\circ\text{C}$  unless otherwise specified)**

Symbol	Parameter	Test Condition	Min.	Typ.	Max.	Units
<b>Off Characteristic</b>						
$V_{(BR)DSS}$	Drain-Source Breakdown Voltage	$V_{GS}=0V, I_D=250\mu A$	60	-	-	V
$I_{DSS}$	Zero Gate Voltage Drain Current	$V_{DS}=60V, V_{GS}=0V,$	-	-	1	$\mu A$
$I_{GSS}$	Gate to Body Leakage Current	$V_{DS}=0V, V_{GS}=\pm 20V$	-	-	$\pm 100$	nA
<b>On Characteristics</b>						
$V_{GS(th)}$	Gate Threshold Voltage	$V_{DS}=V_{GS}, I_D=250\mu A$	1	1.4	2	V
$R_{DS(on)}$	Static Drain-Source on-Resistance note2	$V_{GS}=10V, I_D=3A$	-	75	100	m $\Omega$
		$V_{GS}=4.5V, I_D=2A$	-	85	120	
<b>Dynamic Characteristics</b>						
$C_{iss}$	Input Capacitance	$V_{DS}=25V, V_{GS}=0V, f=1.0MHz$	-	350	-	pF
$C_{oss}$	Output Capacitance		-	29	-	pF
$C_{riss}$	Reverse Transfer Capacitance		-	23	-	pF
$Q_g$	Total Gate Charge	$V_{DS}=30V, I_D=3A, V_{GS}=10V$	-	9	-	nC
$Q_{gs}$	Gate-Source Charge		-	1.5	-	nC
$Q_{gd}$	Gate-Drain ("Miller") Charge		-	2	-	nC
<b>Switching Characteristics</b>						
$t_{d(on)}$	Turn-on Delay Time	$V_{DD}=30V, I_D=2A, R_{GEN}=3\Omega,$ $V_{GS}=10V$	-	5	-	ns
$t_r$	Turn-on Rise Time		-	7	-	ns
$t_{d(off)}$	Turn-off Delay Time		-	37	-	ns
$t_f$	Turn-off Fall Time		-	22	-	ns
<b>Drain-Source Diode Characteristics and Maximum Ratings</b>						
$I_S$	Maximum Continuous Drain to Source Diode Forward Current		-	-	3	A
$I_{SM}$	Maximum Pulsed Drain to Source Diode Forward Current		-	-	12	A
$V_{SD}$	Drain to Source Diode Forward Voltage	$V_{GS} = 0V, I_S=3A$	-	-	1.2	V

**Notes:**

1. Repetitive Rating: Pulse Width Limited by Maximum Junction Temperature
2. Pulse Test: Pulse Width  $\leq 300\mu s$ , Duty Cycle  $\leq 0.5\%$

Typical Electrical and Thermal Characteristics (Curves)

Figure 1: Output Characteristics

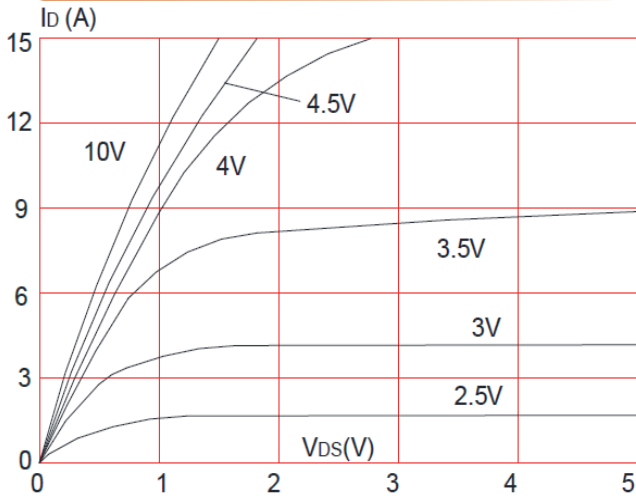

Figure 2: Typical Transfer Characteristics

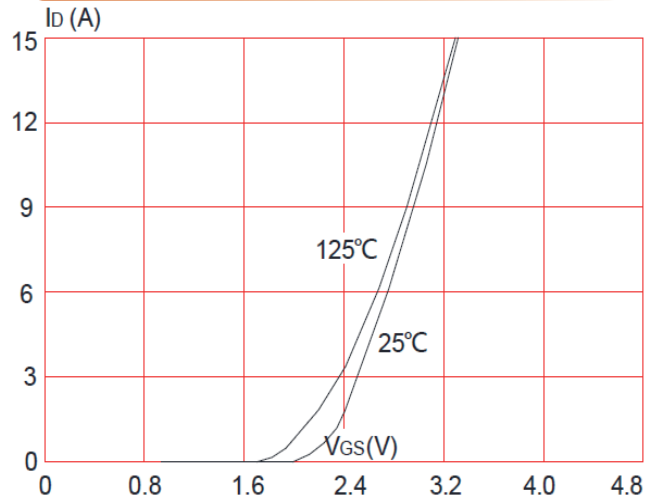

Figure 3: On-resistance vs. Drain Current

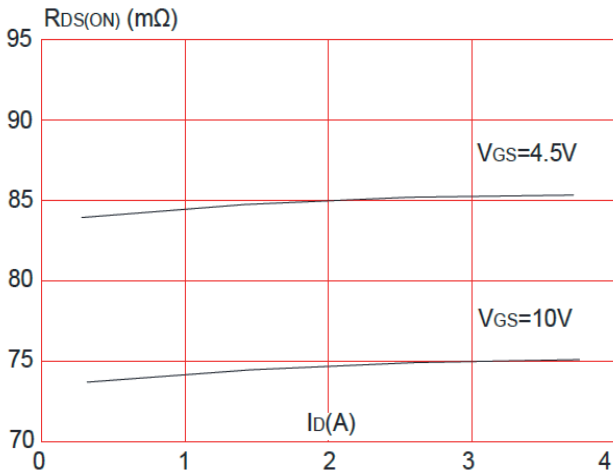

Figure 4: Body Diode Characteristics

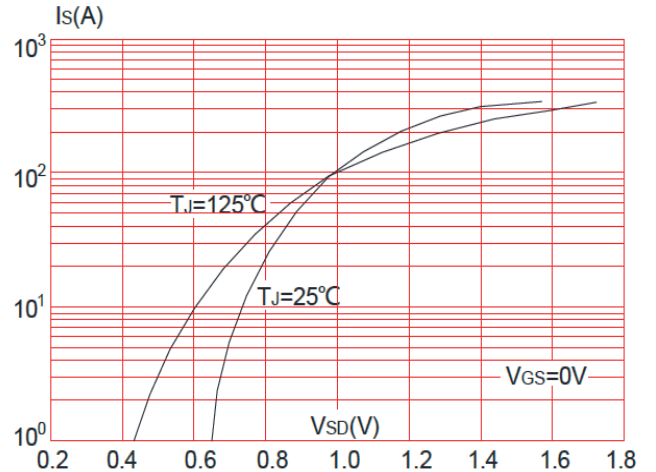

Figure 5: Gate Charge Characteristics

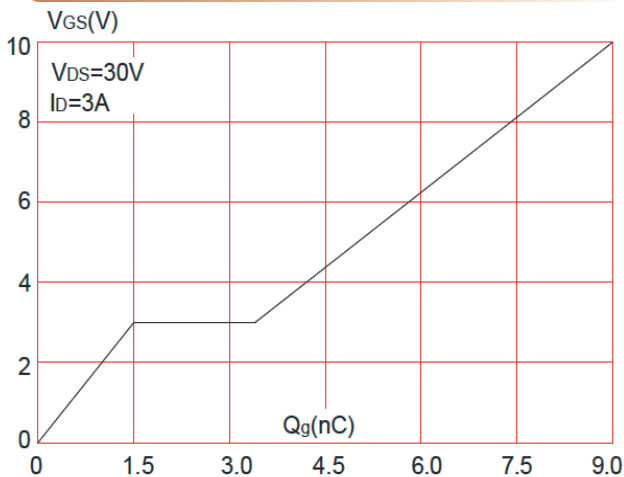
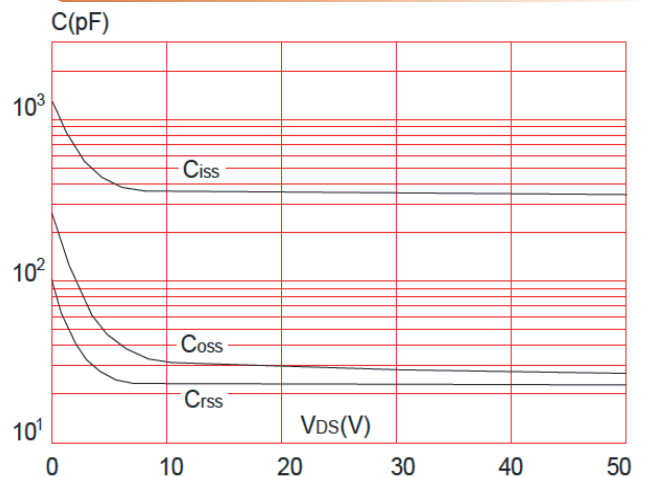

Figure 6: Capacitance Characteristics



Typical Performance Characteristics

Figure 7: Normalized Breakdown Voltage vs. Junction Temperature

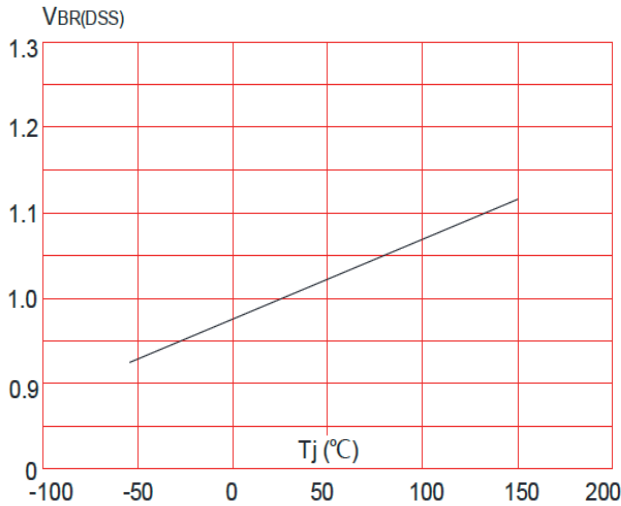

Figure 8: Normalized on Resistance vs. Junction Temperature

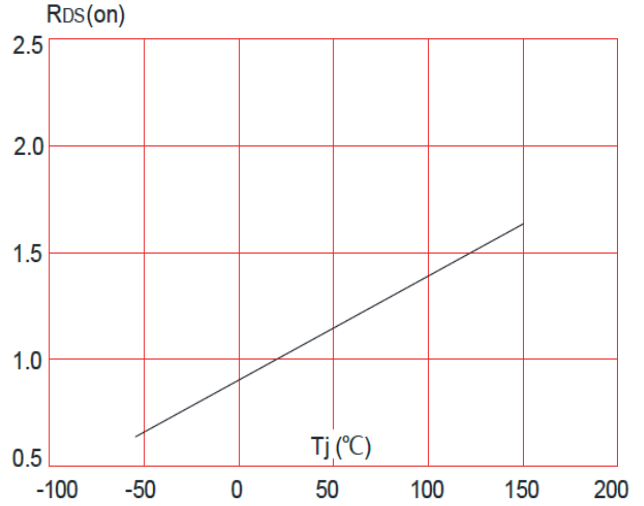

Figure 9: Maximum Safe Operating Area

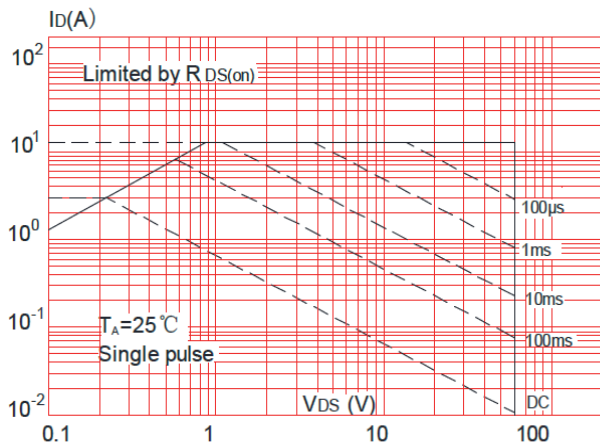

Figure 10: Maximum Continuous Drain Current vs. Ambient Temperature

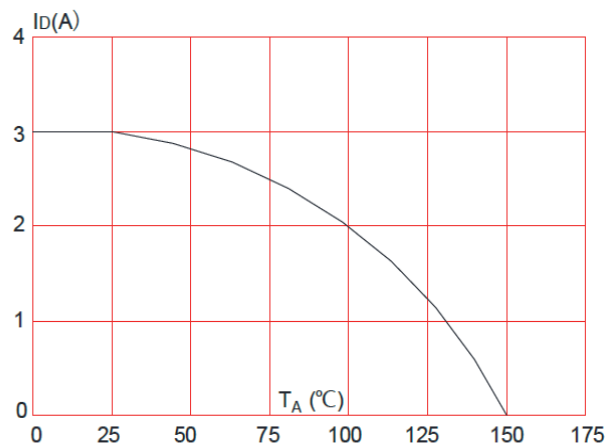
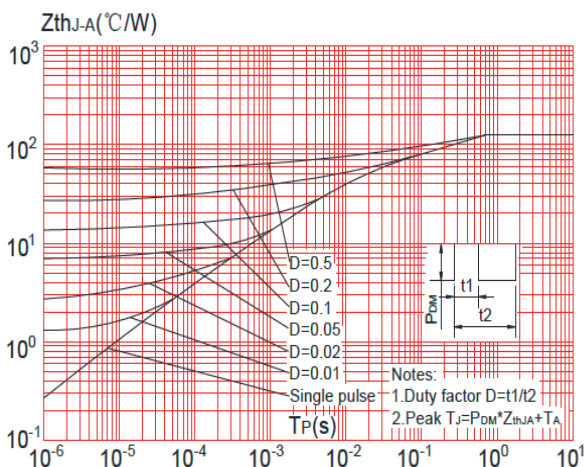

Figure 11: Maximum Effective Transient Thermal Impedance Junction to Ambient



Test Circuit

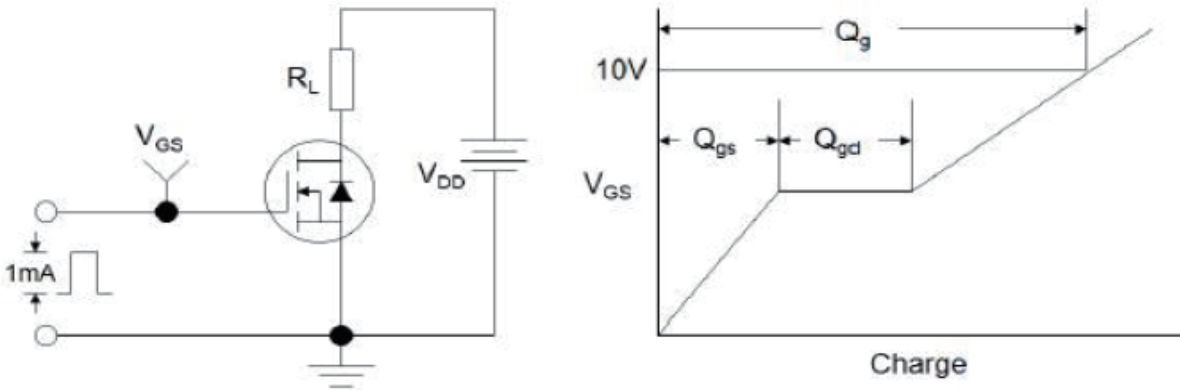

Figure 1: Gate Charge Test Circuit & Waveform

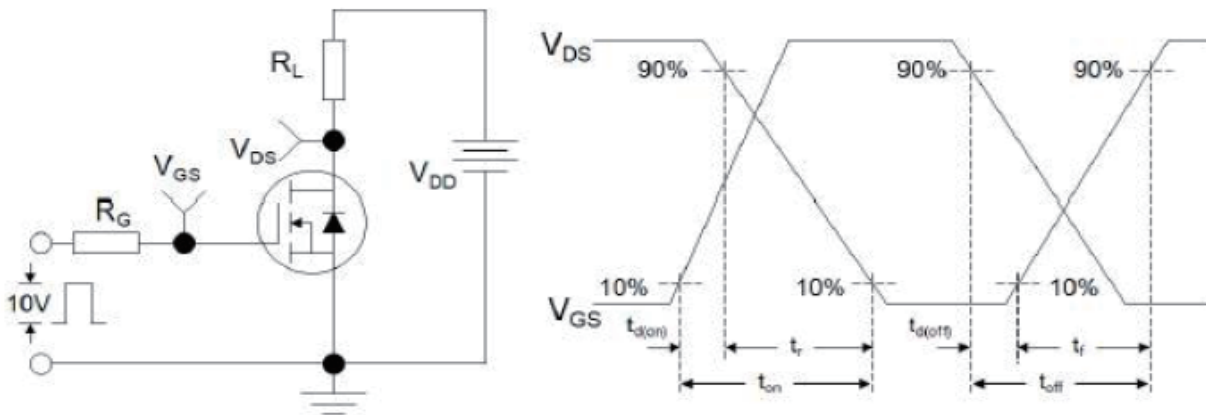

Figure 2: Resistive Switching Test Circuit & Waveforms

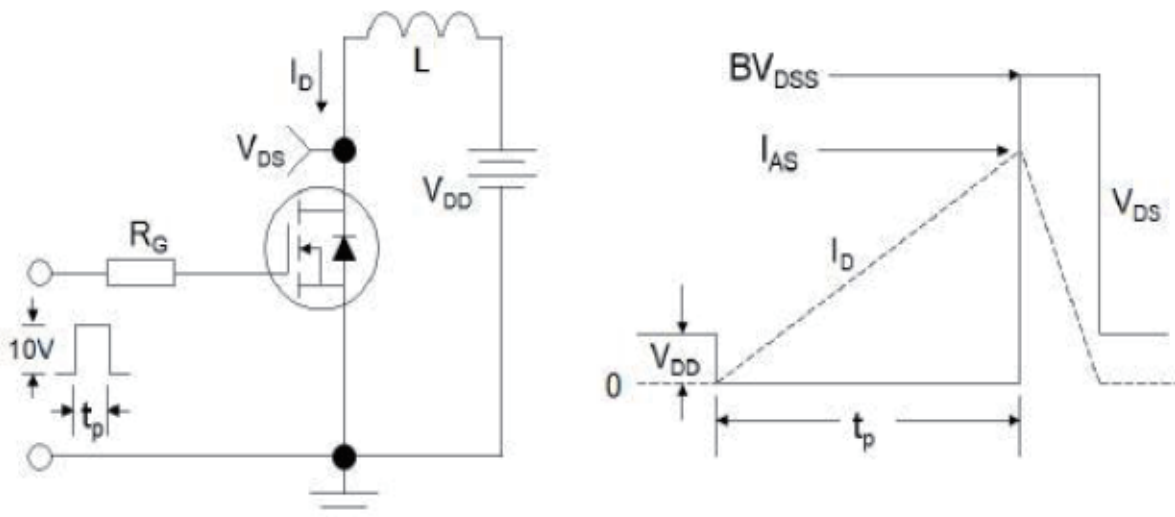
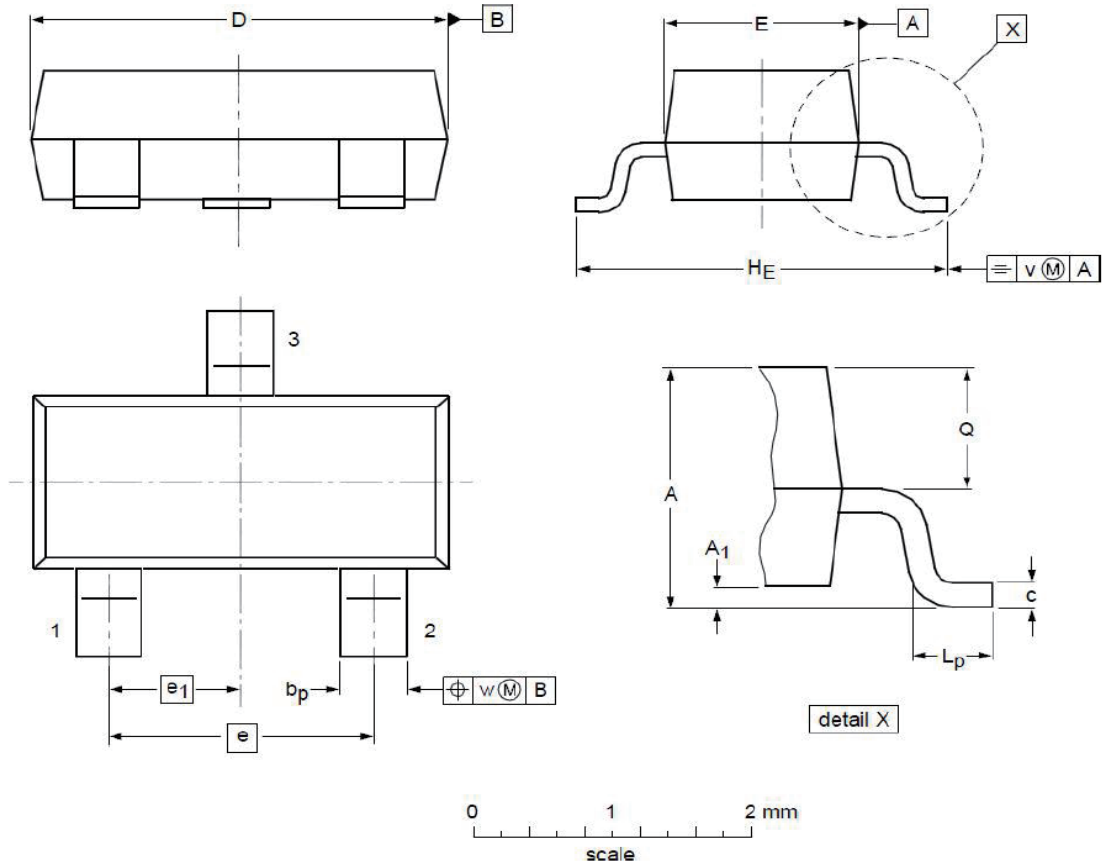

Figure 3: Unclamped Inductive Switching Test Circuit & Waveforms

SOT-23 Package Information



DIMENSIONS ( unit : mm )

Symbol	Min	Typ	Max	Symbol	Min	Typ	Max
<b>A</b>	0.9	1.01	1.15	<b>A<sub>1</sub></b>	0.01	0.05	0.1
<b>b<sub>p</sub></b>	0.3	0.42	0.5	<b>c</b>	0.08	0.13	0.15
<b>D</b>	2.8	2.92	3	<b>E</b>	1.2	1.33	1.4
<b>e</b>	--	1.9	--	<b>e<sub>1</sub></b>	--	0.95	--
<b>H<sub>E</sub></b>	2.25	2.4	2.55	<b>L<sub>p</sub></b>	0.3	0.42	0.5
<b>Q</b>	0.45	0.49	0.55	<b>v</b>	--	0.2	--
<b>w</b>	--	0.1	--				