

### 1. 器件名称

非绝缘型灵敏门极双向三端晶闸管(即: 灵敏门极双向可控硅)

### 2. 主要用途

适合于TTL、HTL、CMOS 电路, 主要用于小功率交流开关、风扇控制、照明控制等

### 3. 极限值 (Ta=25°C)

- T<sub>stg</sub>——贮存温度 ..... -40~125 °C
- T<sub>j</sub>——结温 ..... -40~125 °C
- P<sub>GM</sub>——峰值门极功耗 ..... 1.5W
- V<sub>DRM</sub>——重复峰值断态电压 ..... 800V
- I<sub>T (RMS)</sub>——RMS 通态电流 (Ta=107°C) ..... 4.0A
- V<sub>GM</sub>——峰值门极电压 ..... 7.0V
- I<sub>GM</sub>——峰值门极电流 ..... 1.0A
- I<sub>TSM</sub>——浪涌通态电流(一个周期,50/60Hz,峰值,不重复).....25/30A

### 4. 外形图及引脚排列

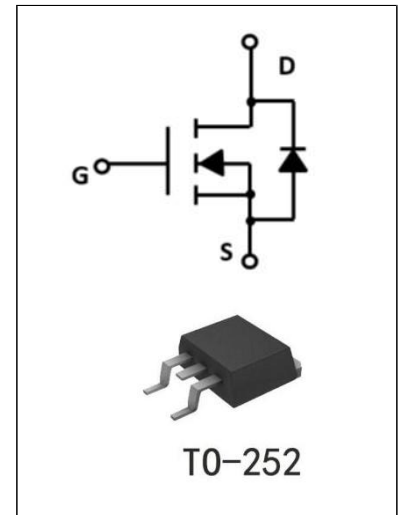

### 5. 电参数 (Ta=25°C)

参数符号	符号说明	最小值	最大值	单位	测试条件
IDRM	重复峰值断态电流		1.0	mA	VD=VDRM,单相,半波,TJ=125°C
VTM	峰值通态电压		1.7	V	IT=7.0A,快速测量
I+GT1	门极触发电流		10	mA	VD=12V, RL=10 ohm
I-GT1	门极触发电流		10	mA	VD=12V, RL=10 ohm
I-GT3	门极触发电流		10	mA	VD=12V, RL=10 ohm
I+GT3	门极触发电流		20	mA	VD=12V, RL=10 ohm
VGT	门极触发电压		1.5	V	VD=12V, RL=10 ohm
VGD	不触发门极电压	0.2		V	TJ=125°C,VD=1/2VDRM
(dv/dt)c	断态电压临界				TJ=125°C,VD=2/3VDRM
	上升率	5		V/μS	(di/dt)c=-0.5A/ms
Rth(j-c)	热阻		3.0	°C/W	结到外壳
IH	维持电流		10	mA	

## 6. 特性曲线

图一、门极特性

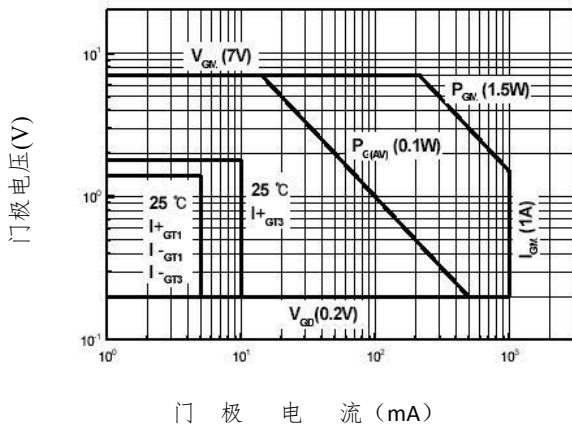

图三、门极触发电压----结温

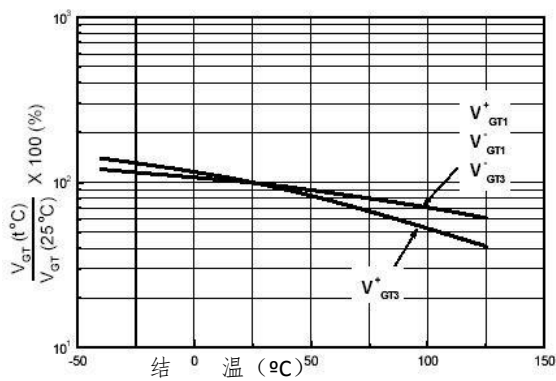

图五、通态电流---外壳温度

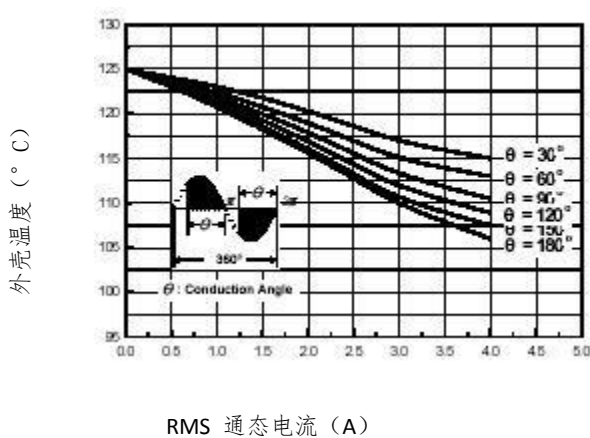

图二、通态电压

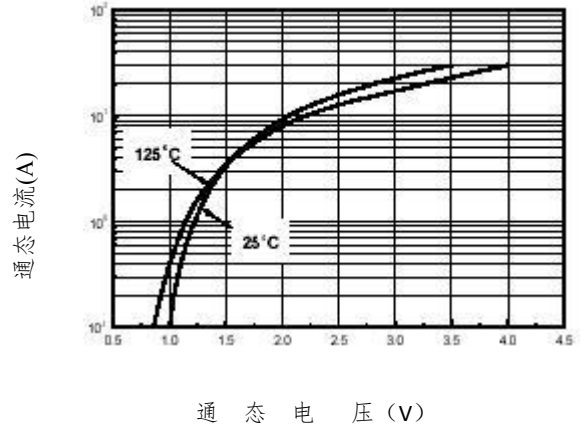

图四、通态电流---最大功耗

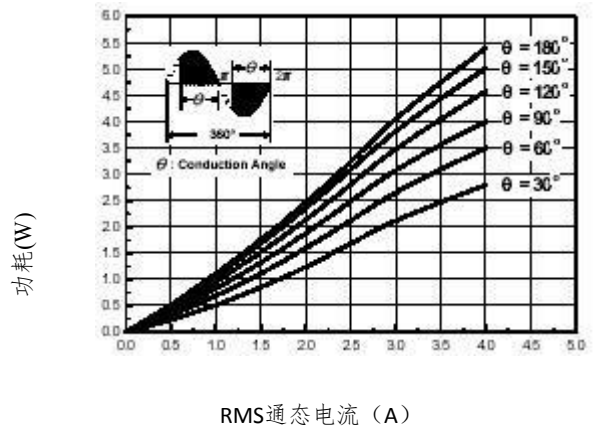

图六、浪涌通态最大电流（不重复）

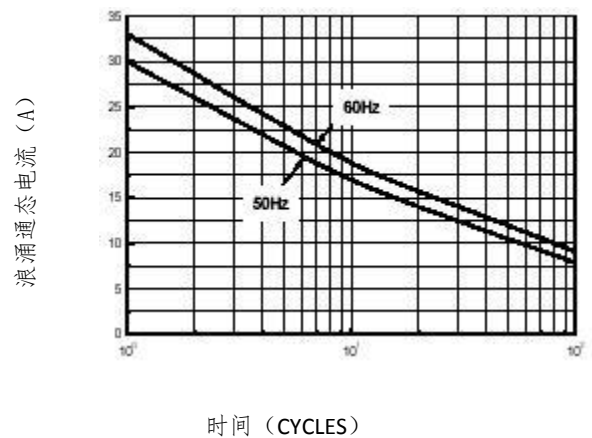

图七、门极触发电流----结温

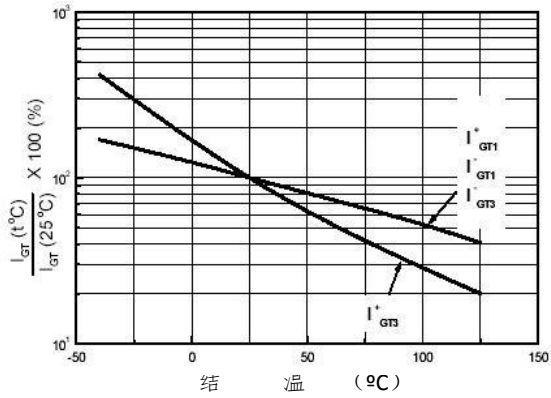

图八、瞬态热阻

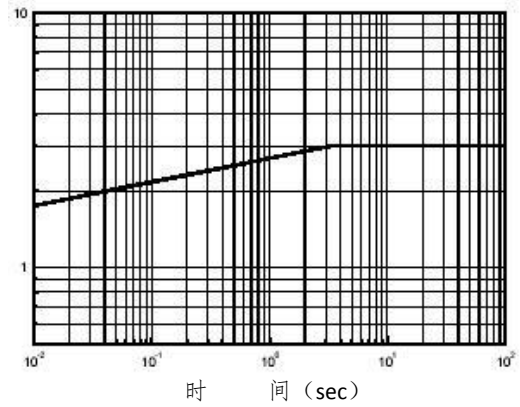

图九、门极触发特性测试电路

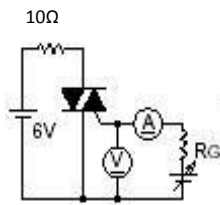

测试方式 I

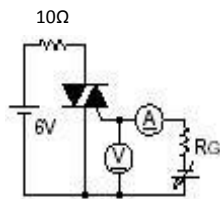

测试方式 II

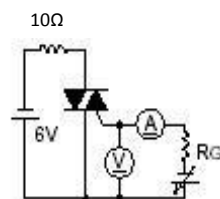

测试方式 III

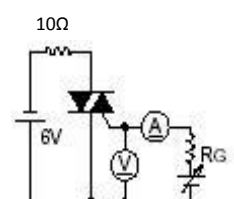

测试方式



**NOTE:**

1. Exceeding the maximum ratings of the device in performance may cause damage to the device, even the permanent failure, which may affect the dependability of the machine. Please do not exceed the absolute maximum ratings of the device when circuit designing.
2. When installing the heat sink, please pay attention to the torsional moment and the smoothness of the heat sink.
3. MOSFETs is the device which is sensitive to the static electricity, it is necessary to protect the device from being damaged by the static electricity when using it.
4. Shenzhen Minos reserves the right to make changes in this specification sheet and is subject to change without prior notice.

**CONTACT:**

**深圳市迈诺斯科技有限公司（总部）**

地址 :深圳市福田区华富街道田面社区深南中路4026号田面城市大厦22B-22C

邮编 : 518025

电话 : 0755-83273777