

REV(版本)	DESCRIPTION(描述)	NAME(名字)	DATE(日期)

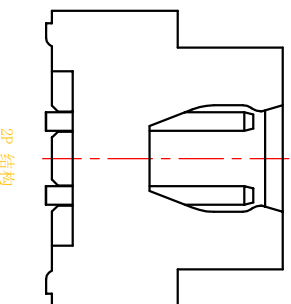

OKT	Dim A	Dim B	Dim C
2	2.50	7.50	10.00
3	5.00	10.00	12.50
4	7.50	12.50	15.00
5	10.00	15.00	17.50
6	12.50	17.50	20.00
7	15.00	20.00	22.50
8	17.50	22.50	25.00
9	20.00	25.00	27.50
10	22.50	27.50	30.00
11	25.00	30.00	32.50
12	27.50	32.50	35.00
13	30.00	35.00	37.50
14	32.50	37.50	40.00
15	35.00	40.00	42.50
16	37.50	42.50	45.00

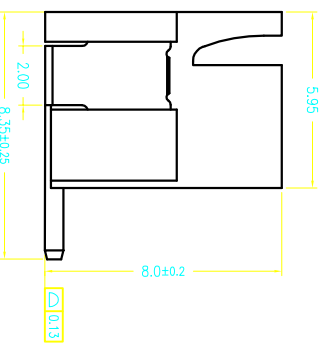
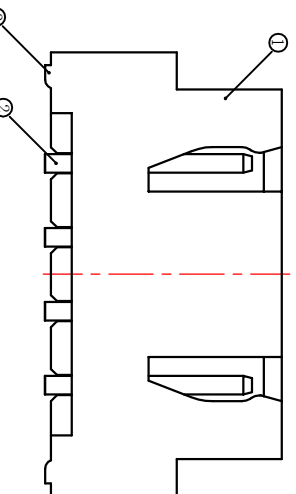
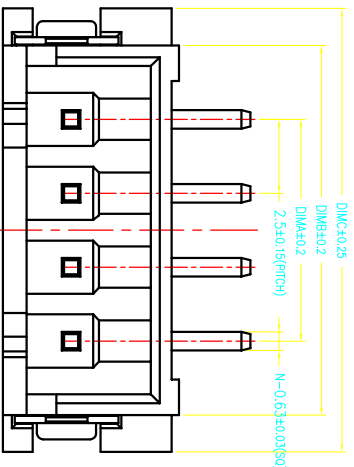
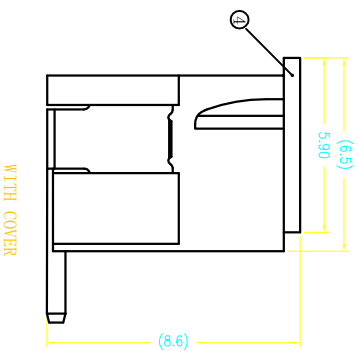
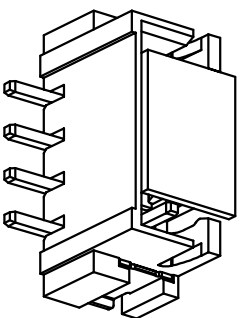
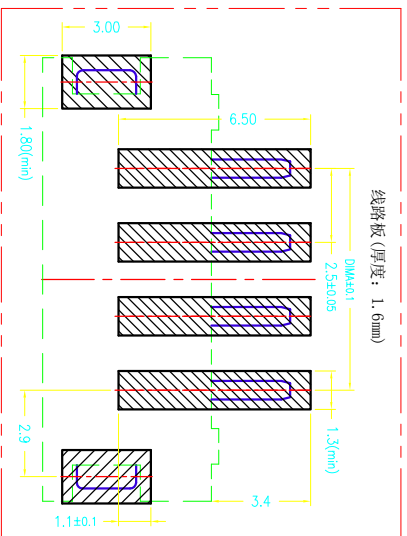

序号	项目	描述	备注
1	塑胶	LCP	
2	端子	黄铜	
3	焊片	黄铜	
4	盖子		

技术指标:

1. 塑件表面应光洁、无毛边、无明显收缩、缺陷、裂纹等现象。
2. 温度范围: -40° C~85° C.
3. 额定电压: 250V, AC/DC.
4. 接触电阻: ≤20mΩ.
5. 绝缘电阻: ≥1000MΩ.
6. 额定电流: 4A, AC/DC.

深圳市连欣科技有限公司

品名 (TITLE) Pitch:2.50mm 立式 SMT 制图 (DR) XIAO

料号 (DMC,NO) XDWF-2501-**P 校对 (CHKD) Alex

比例 (SCALE) 1:1 单位 (UNITS) mm 页码 (SHEET) 1 OF 1 尺寸 (SIZE) A4 版本 (REV) A

一般公差 (TOLERANCE)
 X ±0.10 XX ±0.10
 Y ±0.20 XXX ±0.05
 ANGLES ±1°