



深圳市凯越翔电子有限公司

石英谐振器规格书

产品名称:	石英晶振谐振器
产品型号:	2012/32.768 KHZ
产品参数:	7PF/±10ppm
原厂型号:	K2A327680710
凯越翔技术部:	董宗全

客户确认印栏

认证印章	负责人印章
年 月 日	年 月 日

本规格章程连同本页合共 5 页

CRYSTAL SPECIFICATION

1. Description : Quartz Crystal
2. Nominal Frequency : 32.768 KHz
3. Center Frequency : 32.768 KHz
4. Dimension & Drawing No. : SX-2012 ; SXD-00309
5. Oscillation Mode : Fundamental
6. Cutting Mode :
7. Packing Style : TP-158
8. Measurement Instrument : S&A 250B(Calculated FL)
9. Electrical Characteristics :

[1] Operating Conditions :

Item	Symbol	MIN.	TYP.	MAX.	Unit	Condition
Operating Temperature Range	Topt	-40		85	°C	
Storage Temperature Range	Tstg	-4 0		8 5	°C	
Load Capacitance	CL		7		pF	
Drive Level	DL		0.1	0.5	μW	

[2] Frequency Stability :

Item	Symbol	MIN.	TYP.	MAX.	Unit	Condition
Tolerance	dF/Fo	-10		10	ppm	Refer to Center Frequency @25±3°C DL = 0.1 μW
Freq. vs Temp. Coefficient	dF/dT	-0.04	-0.036		ppm/°C ²	
Turnover Temperature	TT	20	25	30	°C	
Aging	dF/F25	-3		3	ppm	Per Year

dF/Fo: Frequency Deviation Refer to Center

Frequency dF/F25: Frequency Deviation Refer

to 25 °C Frequency

[3] Electrical Performance :

Item	Symbol	MIN.	TYP.	MAX.	Unit	Condition
Equivalent Series Resistance	ESR			30	kΩ	@Series
Shunt Capacitance	Co	1.1	1.5	1.9	pF	
Motional Capacitance	C1	5	6	7	fF	
Motional Inductance	L1	3	3.8	4.6	kH	
Quality Factor	Q	9000				
Insulation Resistance	IR	500			MΩ	@DC 100 Volt

10. Marking : Laser

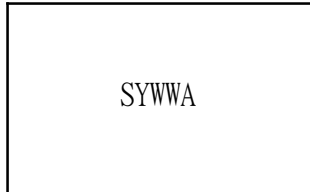
<p>*Y=Last 1 digit of the year *WW=Week of the year * CL : 12.5 -> A</p>	
--	---

11. Remark :

<p>*Lead Free, RoHS compliant</p>

TOP VIEW

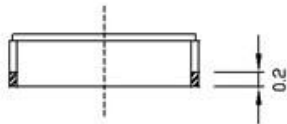
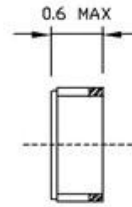
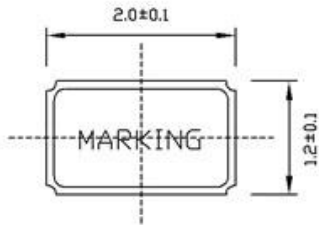

BOTTOM VIEW

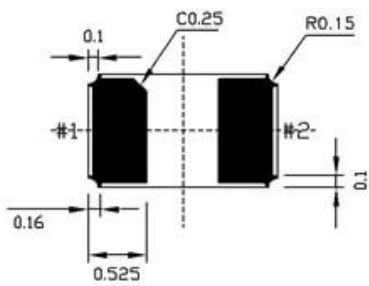

LAND PATTERN (REFERENCE)

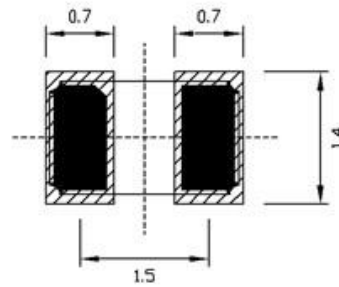

		DRAWING NAME	SX-2012 DIMENSION/MARKING
		DRAWING NO.	SXD-00309

1.CARRIER TYPE

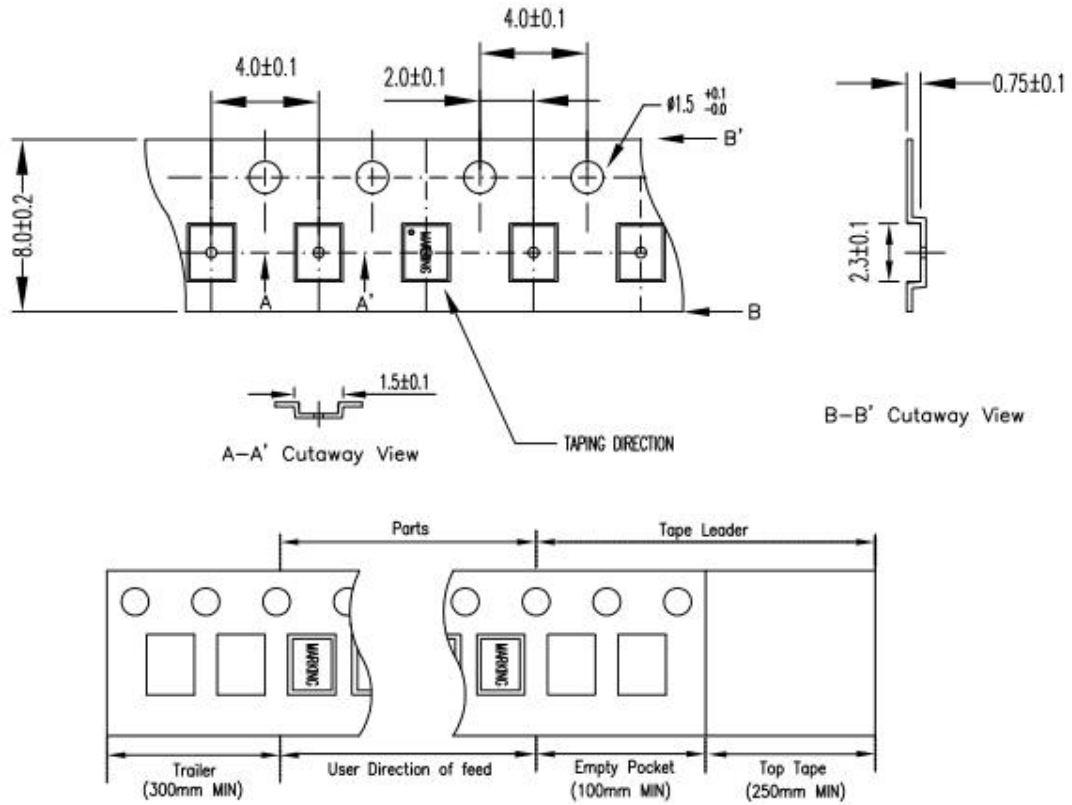

2.REEL : 3000PCS

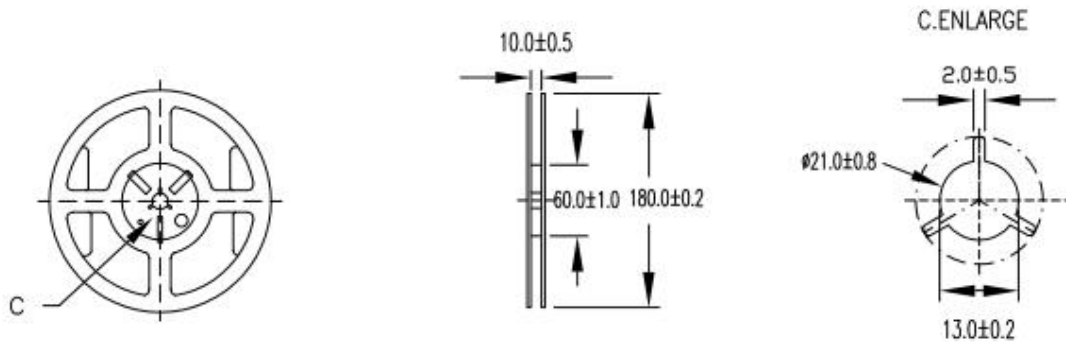

拟制	成望生	审核	董宗全	批准	谢为亮
----	-----	----	-----	----	-----