

General Features

● N-Channel

$$V_{DS} = 40V, I_D = 8A$$

$$R_{DS(ON)} < 19m\Omega @ V_{GS} = 10V$$

$$R_{DS(ON)} < 29m\Omega @ V_{GS} = 4.5V$$

● P-Channel

$$V_{DS} = -40V, I_D = -7A$$

$$R_{DS(ON)} < 35m\Omega @ V_{GS} = -10V$$

$$R_{DS(ON)} < 45m\Omega @ V_{GS} = -4.5V$$

Application

- High power and current handing capability
- Lead free product is acquired
- Surface mount package

Package and Pin Configuration

(SOP-8)

Top View

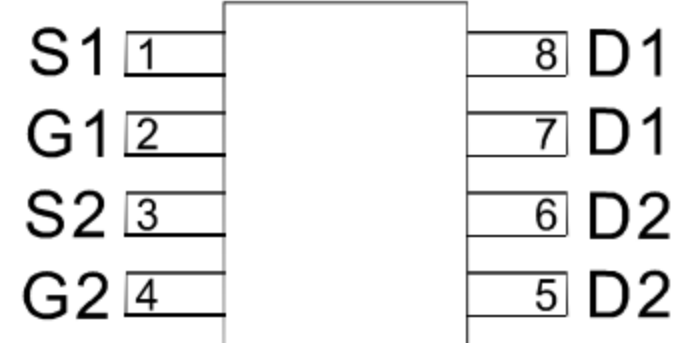

Circuit diagram

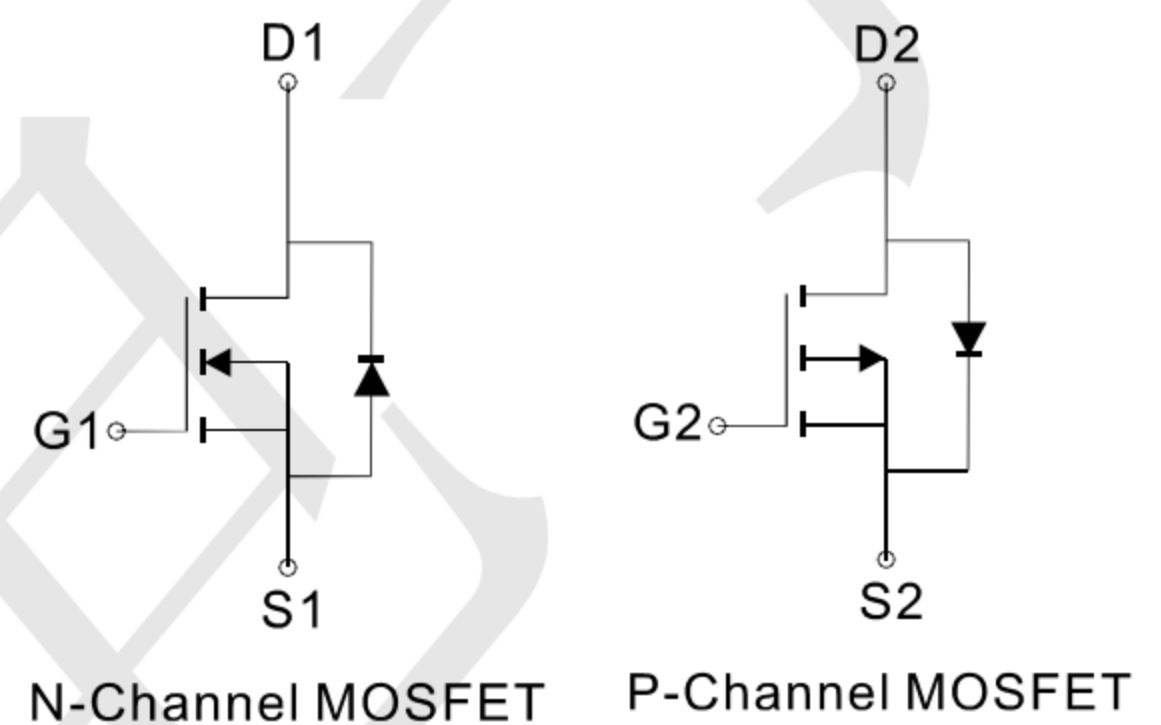

Marking

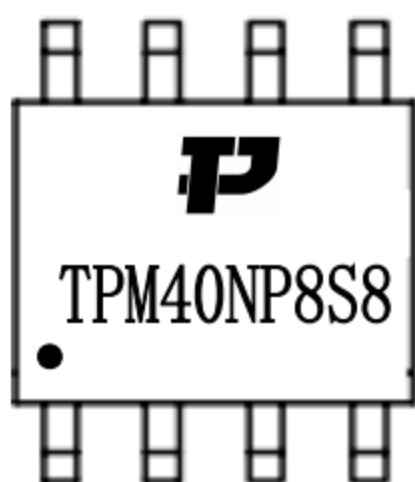

Absolute Maximum Ratings ($T_A = 25^\circ C$ unless otherwise noted)

Parameter	Symbol	N-Channel	P-Channel	Unit
Drain-Source Voltage	V_{DS}	40	-40	V
Gate-Source Voltage	V_{GS}	± 20	± 20	V
Continuous Drain Current	I_D	$T_A = 25^\circ C$	8	-7
		$T_A = 70^\circ C$	6	-5.5
Pulsed Drain Current (Note 1)	I_{DM}	40	-30	A
Maximum Power Dissipation	P_D	2.0	2.0	W
Operating Junction and Storage Temperature Range	T_J, T_{STG}	-55 To 150	-55 To 150	$^\circ C$

Thermal Characteristic

Thermal Resistance, Junction-to-Ambient (Note 2)	$R_{\theta JA}$	N-Ch	62.5	$^\circ C/W$
Thermal Resistance, Junction-to-Ambient (Note 2)	$R_{\theta JA}$	P-Ch	62.5	$^\circ C/W$

N-CH Electrical Characteristics (T_A=25°C unless otherwise noted)

Parameter	Symbol	Condition	Min	Typ	Max	Unit
Off Characteristics						
Drain-Source Breakdown Voltage	BV _{DSS}	V _{GS} =0V, I _D =250μA	40	-	-	V
Zero Gate Voltage Drain Current	I _{DSS}	V _{DS} =40V, V _{GS} =0V	-	-	1	μA
Gate-Body Leakage Current	I _{GSS}	V _{GS} =±20V, V _{DS} =0V	-	-	±100	nA
On Characteristics (Note 3)						
Gate Threshold Voltage	V _{GS(th)}	V _{DS} =V _{GS} , I _D =250μA	1	1.5	2.0	V
Drain-Source On-State Resistance	R _{DS(ON)}	V _{GS} =10V, I _D =8A	-	14	19	mΩ
		V _{GS} =4.5V, I _D =4A	-	19	29	mΩ
Forward Transconductance	g _{FS}	V _{DS} =5V, I _D =8A	33	-	-	S
Dynamic Characteristics (Note 4)						
Input Capacitance	C _{iss}	V _{DS} =20V, V _{GS} =0V, F=1.0MHz	-	415	-	PF
Output Capacitance	C _{oss}		-	112	-	PF
Reverse Transfer Capacitance	C _{rss}		-	11	-	PF
Switching Characteristics (Note 4)						
Turn-on Delay Time	t _{d(on)}	V _{DD} =20V, R _L =2.5Ω V _{GS} =10V, R _{GEN} =3Ω	-	4	-	nS
Turn-on Rise Time	t _r		-	3	-	nS
Turn-Off Delay Time	t _{d(off)}		-	15	-	nS
Turn-Off Fall Time	t _f		-	2	-	nS
Total Gate Charge	Q _g	V _{DS} =20V, I _D =8A, V _{GS} =10V	-	12	-	nC
Gate-Source Charge	Q _{gs}		-	3.2	-	nC
Gate-Drain Charge	Q _{gd}		-	3.1	-	nC
Drain-Source Diode Characteristics						
Diode Forward Voltage (Note 3)	V _{SD}	V _{GS} =0V, I _S =8A	-	0.8	1.2	V

P-CH Electrical Characteristics ($T_A=25^\circ\text{C}$ unless otherwise noted)

Parameter	Symbol	Condition	Min	Typ	Max	Unit
Off Characteristics						
Drain-Source Breakdown Voltage	BV_{DSS}	$V_{GS}=0V, I_D=-250\mu A$	-40	-	-	V
Zero Gate Voltage Drain Current	I_{DSS}	$V_{DS}=-40V, V_{GS}=0V$	-	-	-1	μA
Gate-Body Leakage Current	I_{GSS}	$V_{GS}=\pm 20V, V_{DS}=0V$	-	-	± 100	nA
On Characteristics (Note 3)						
Gate Threshold Voltage	$V_{GS(th)}$	$V_{DS}=V_{GS}, I_D=-250\mu A$	-1.0	-1.5	-2.0	V
Drain-Source On-State Resistance	$R_{DS(on)}$	$V_{GS}=-10V, I_D=-8A$	-	29	35	m Ω
		$V_{GS}=-4.5V, I_D=-4A$	-	34	45	m Ω
Forward Transconductance	g_{FS}	$V_{DS}=-5V, I_D=-8A$	20	-	-	S
Dynamic Characteristics (Note 4)						
Input Capacitance	C_{iss}	$V_{DS}=-20V, V_{GS}=0V,$ $F=1.0MHz$	-	520	-	PF
Output Capacitance	C_{oss}		-	100	-	PF
Reverse Transfer Capacitance	C_{rss}		-	65	-	PF
Switching Characteristics (Note 4)						
Turn-on Delay Time	$t_{d(on)}$	$V_{DD}=-20V, R_L=2.3\Omega$ $V_{GS}=-10V, R_{GEN}=6\Omega$	-	7.5	-	nS
Turn-on Rise Time	t_r		-	5.5	-	nS
Turn-Off Delay Time	$t_{d(off)}$		-	19	-	nS
Turn-Off Fall Time	t_f		-	7	-	nS
Total Gate Charge	Q_g	$V_{DS}=-20V, I_D=-8A$ $V_{GS}=-10V$	-	13	-	nC
Gate-Source Charge	Q_{gs}		-	3.8	-	nC
Gate-Drain Charge	Q_{gd}		-	3.1	-	nC
Drain-Source Diode Characteristics						
Diode Forward Voltage (Note 3)	V_{SD}	$V_{GS}=0V, I_S=-10A$	-	-	-1.2	V

N- Channel Typical Electrical and Thermal Characteristics (Curves)

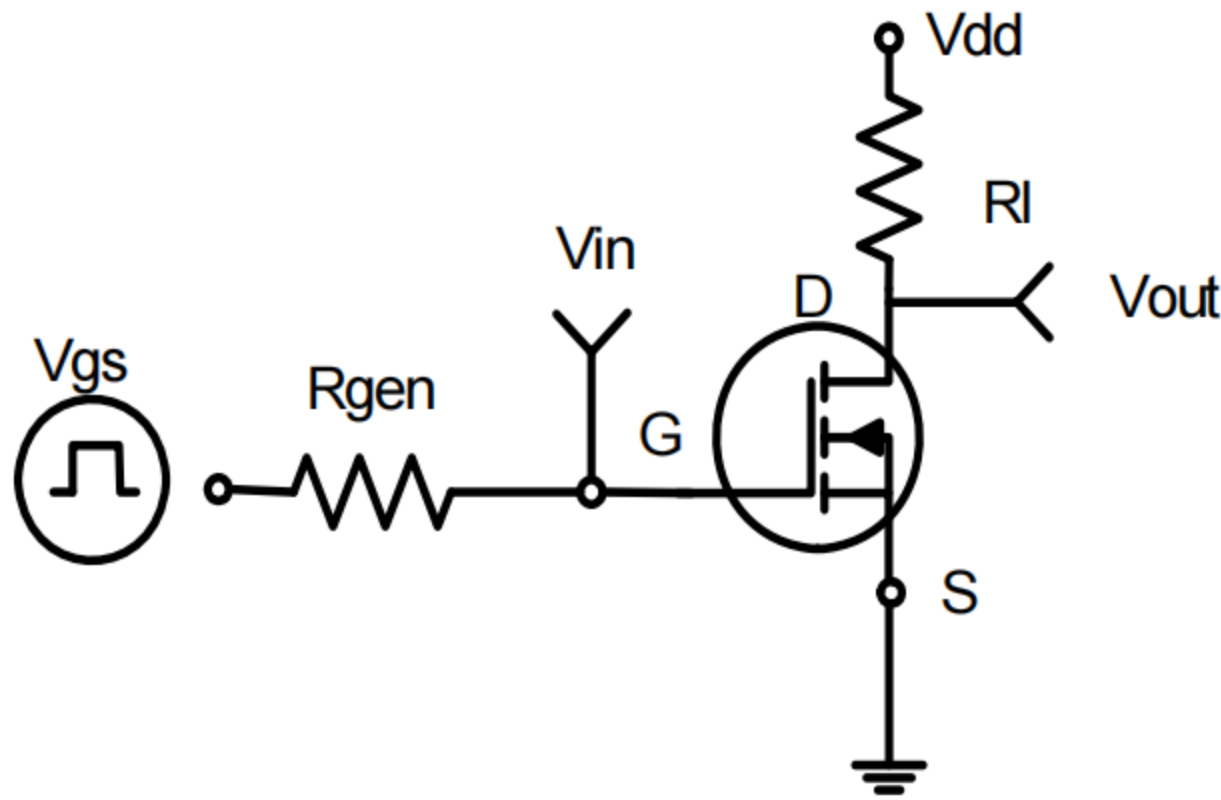

Figure 1: Switching Test Circuit

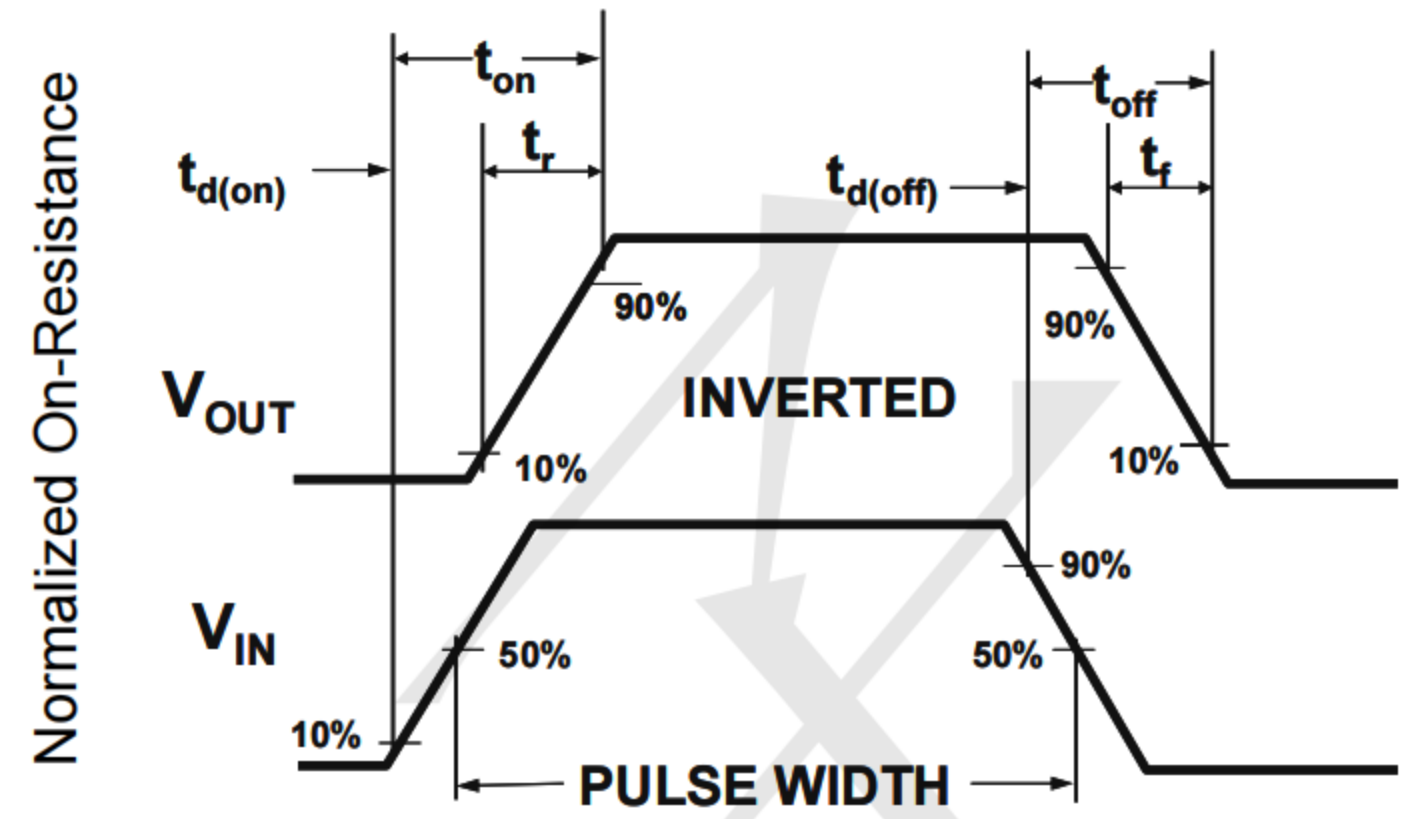

Figure 2: Switching Waveforms

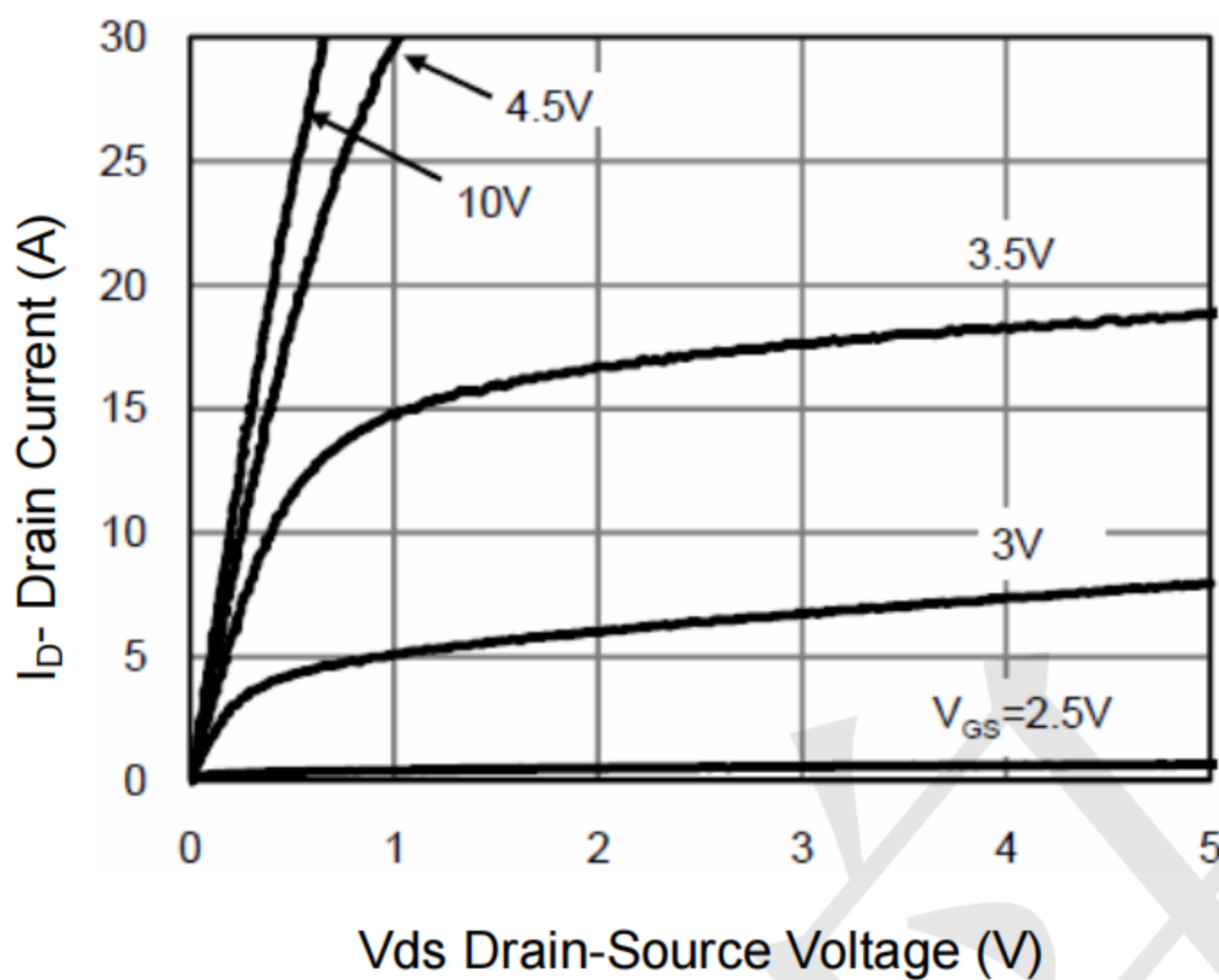

Figure 3 Output Characteristics

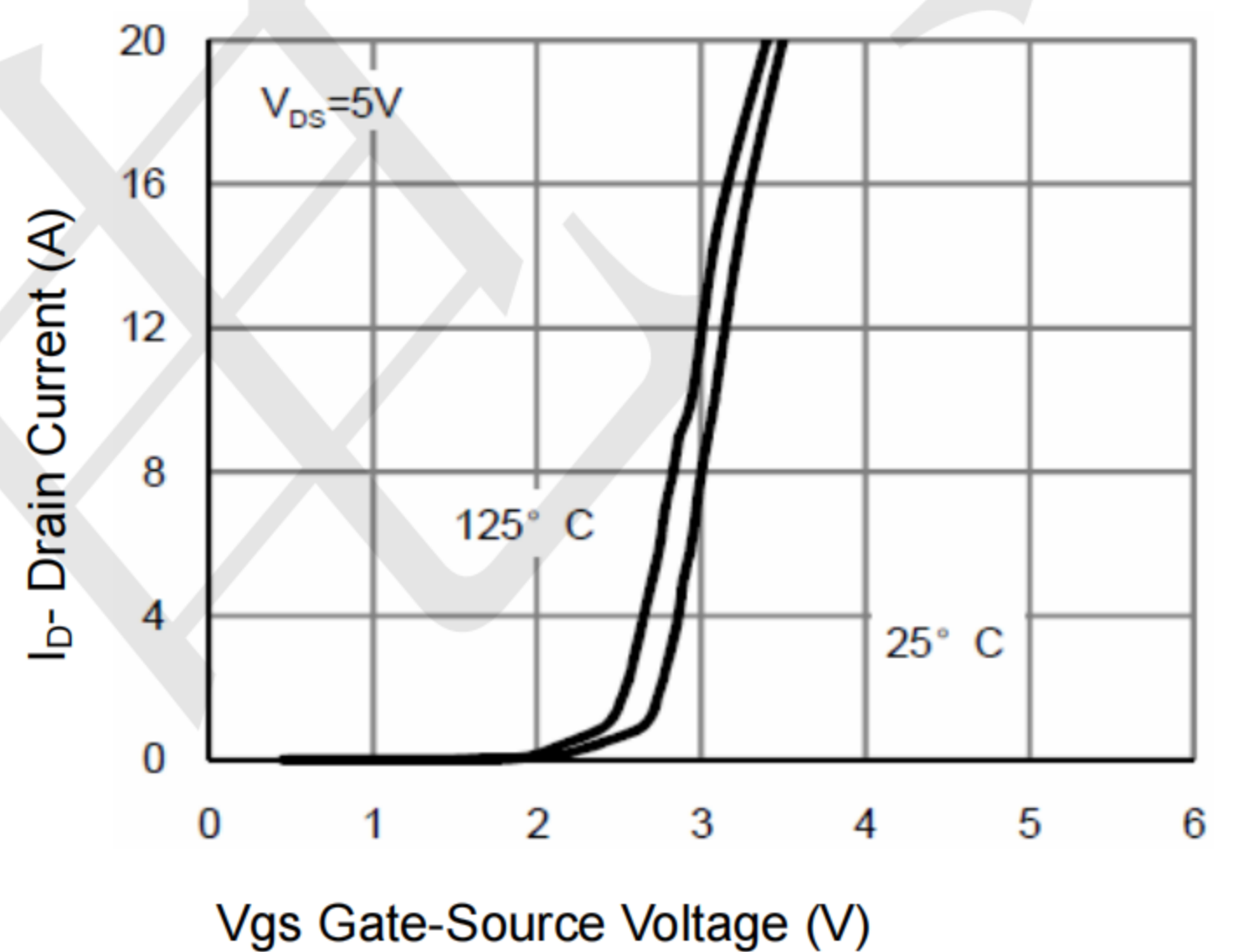

Figure 4 Transfer Characteristics

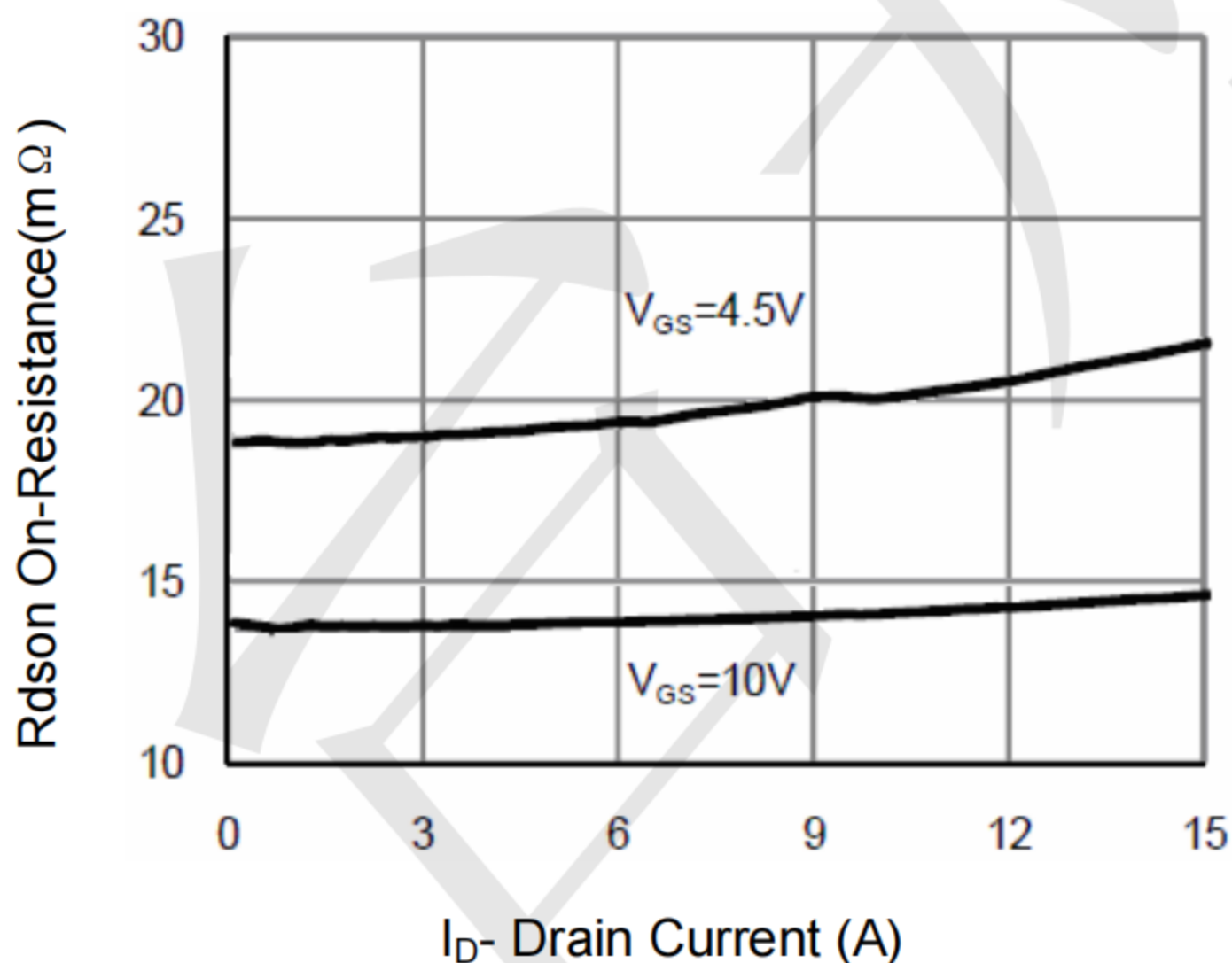

Figure 5 Drain-Source On-Resistance

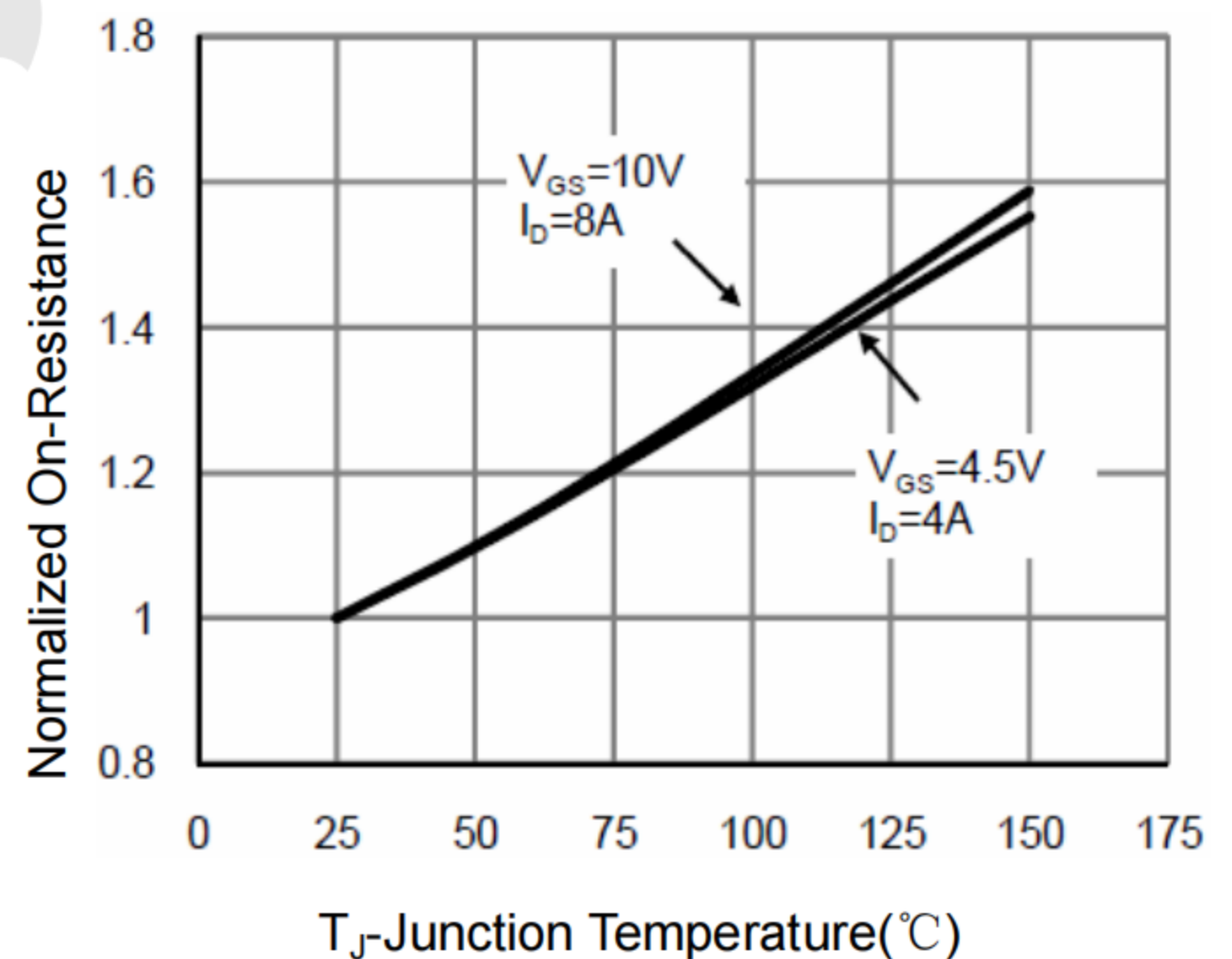

Figure 6 Drain-Source On-Resistance

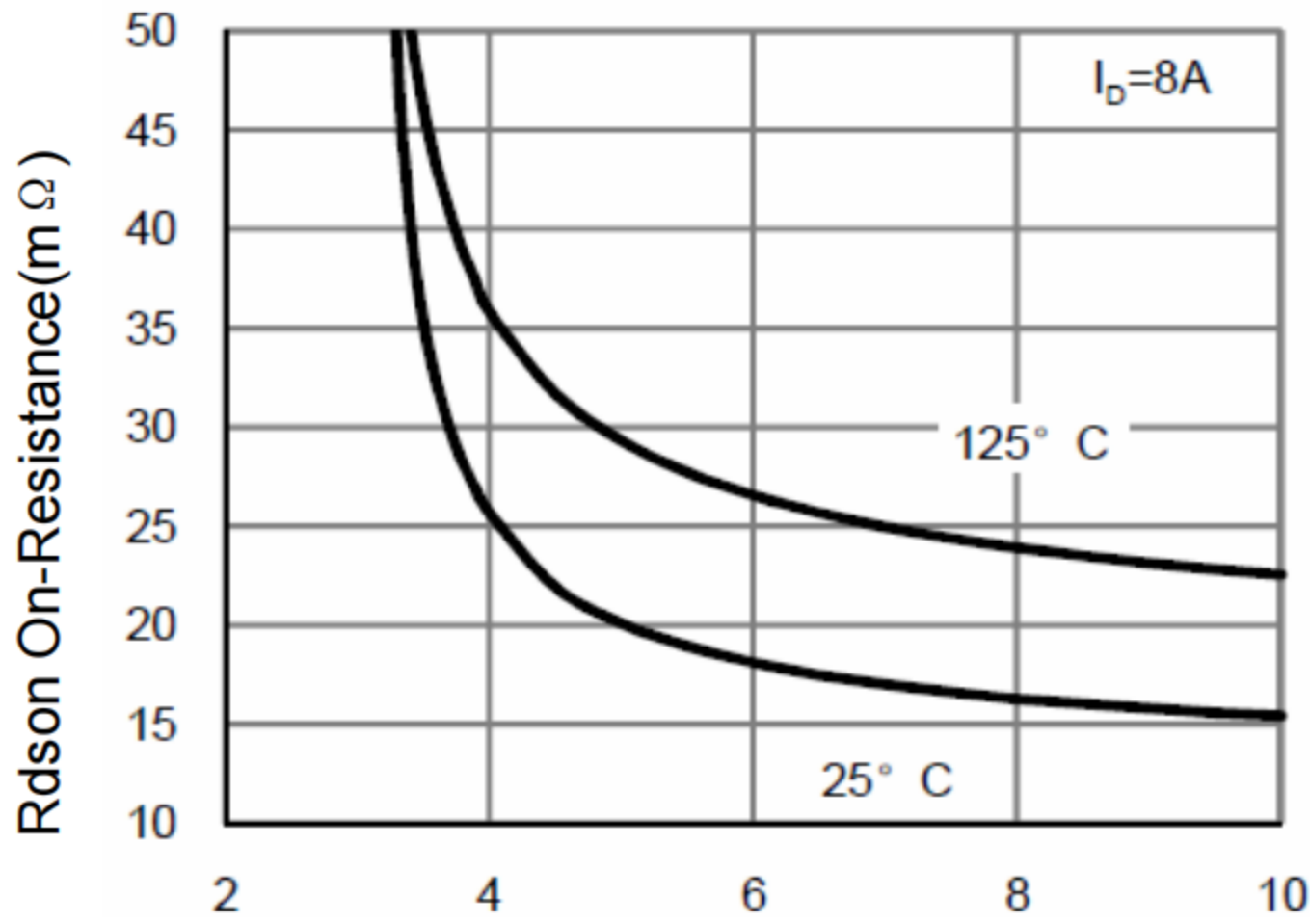

Figure 7 Rdson vs Vgs

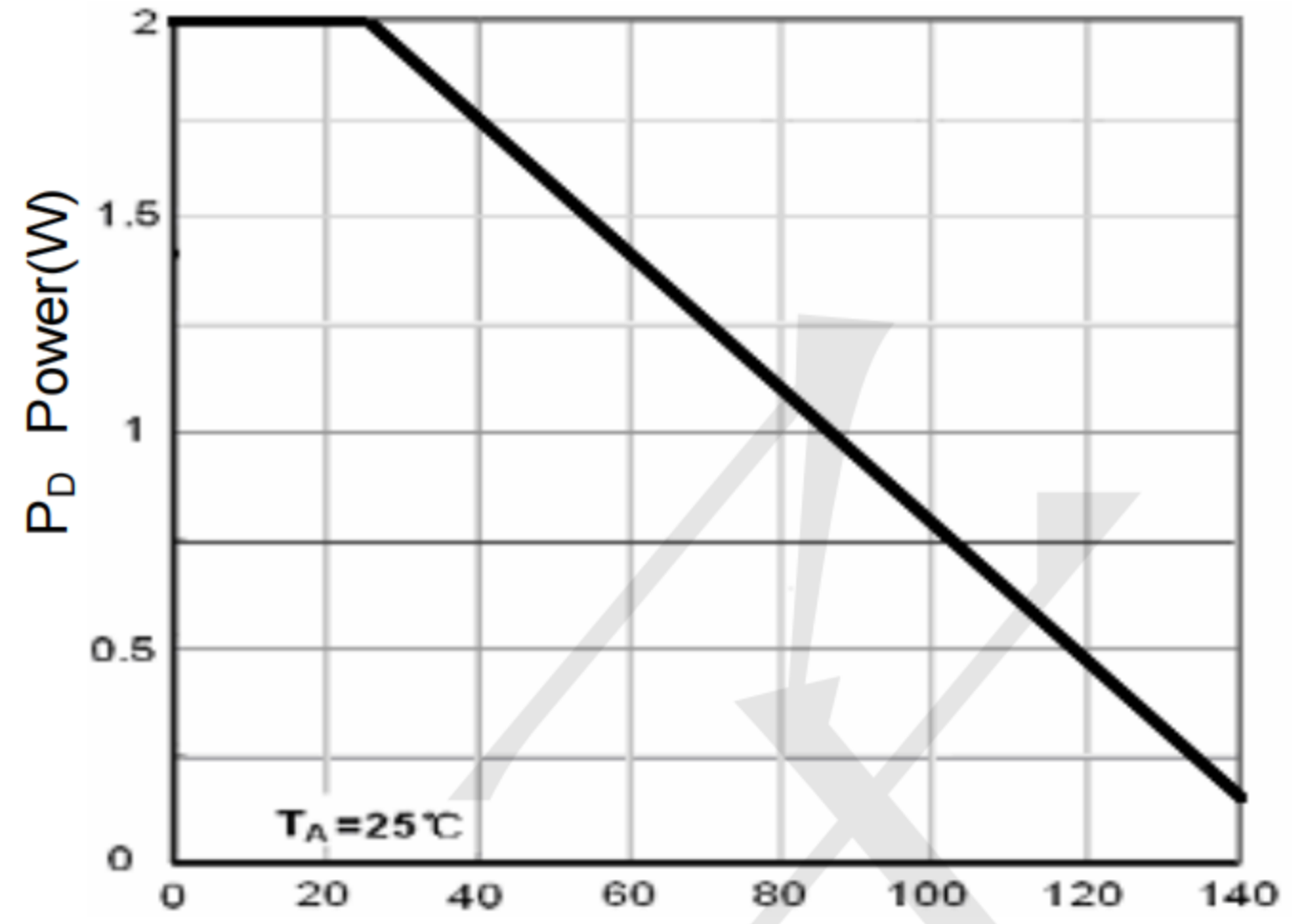

Figure 8 Power Dissipation

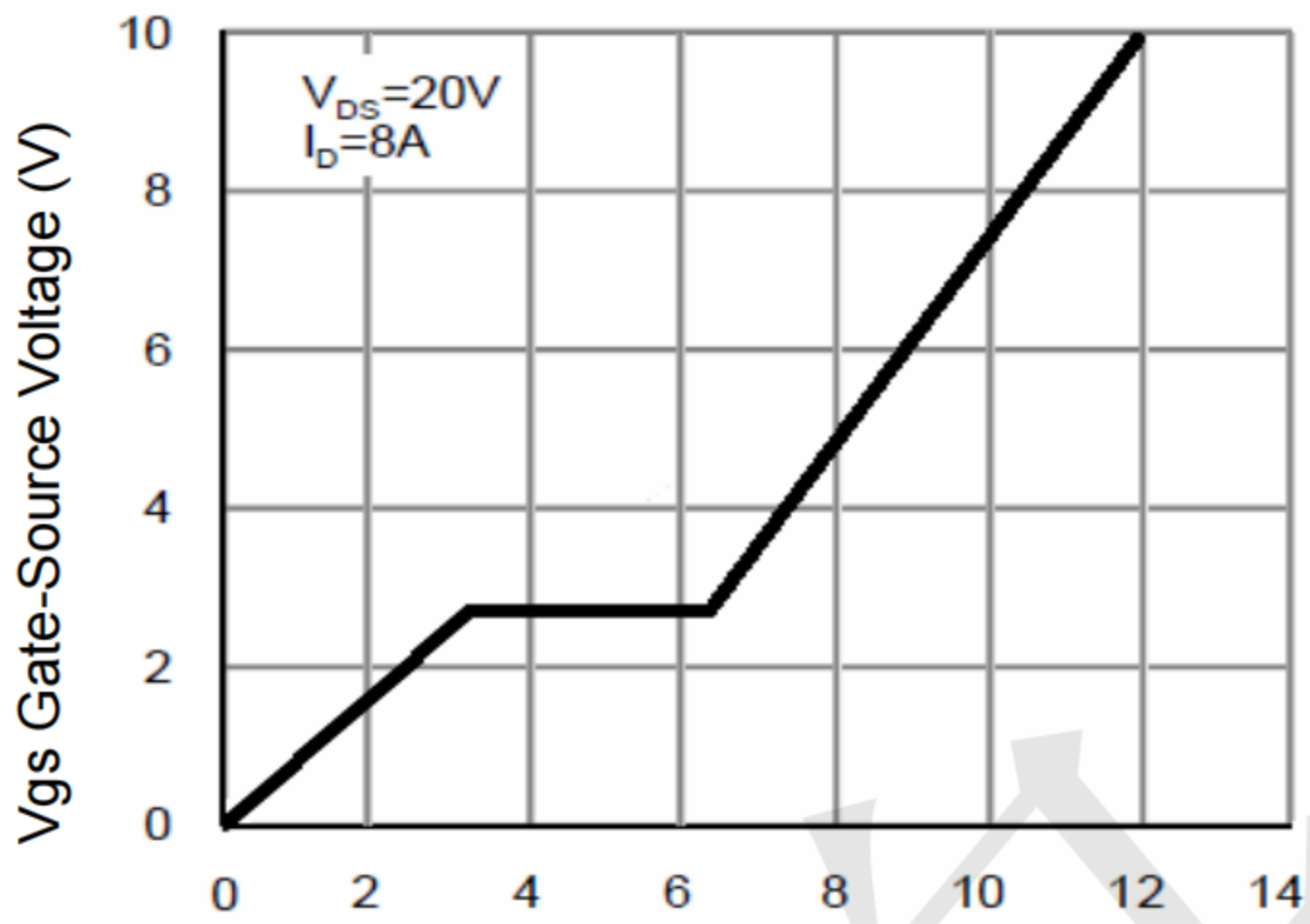

Figure 9 Gate Charge

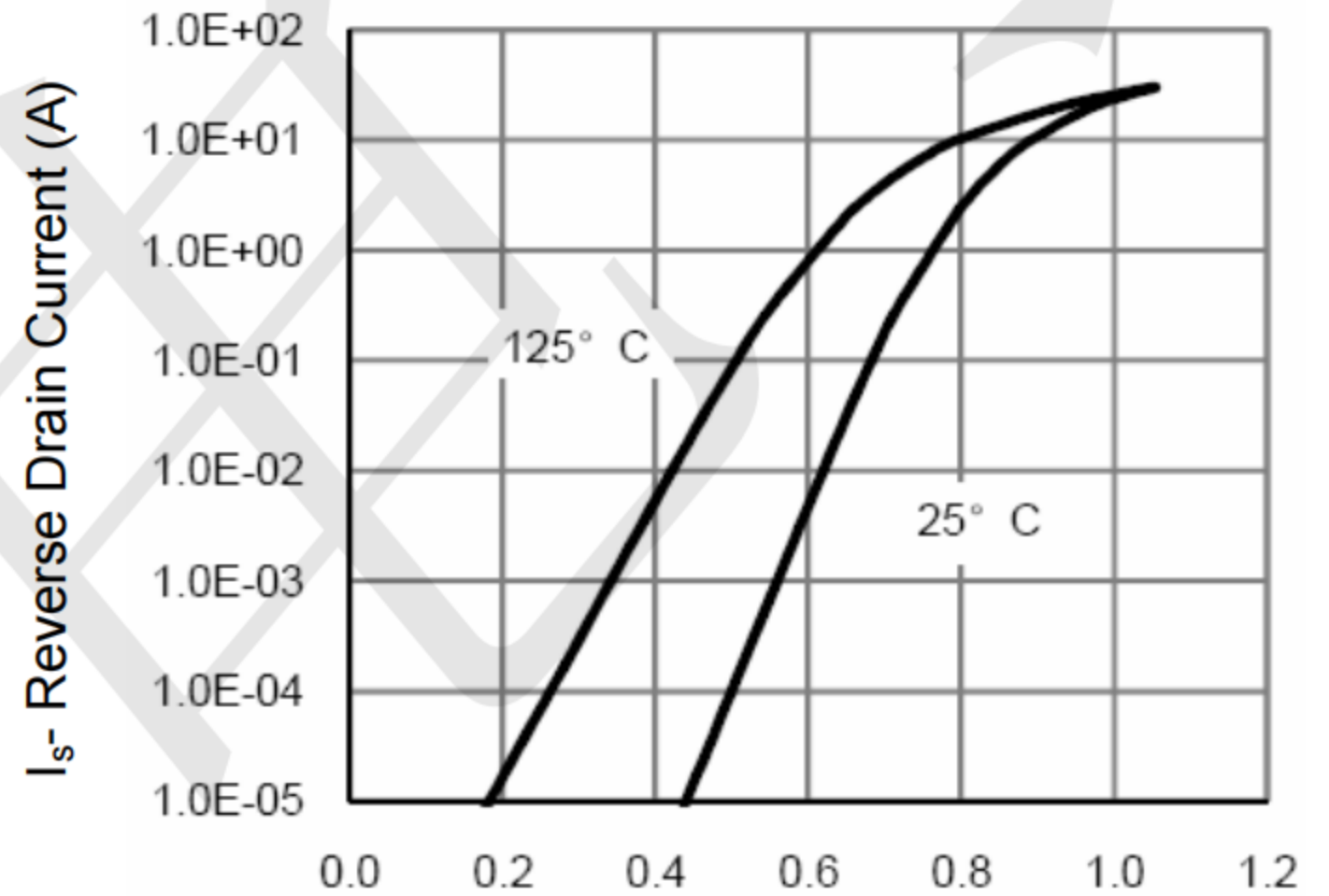

Figure 10 Source- Drain Diode Forward

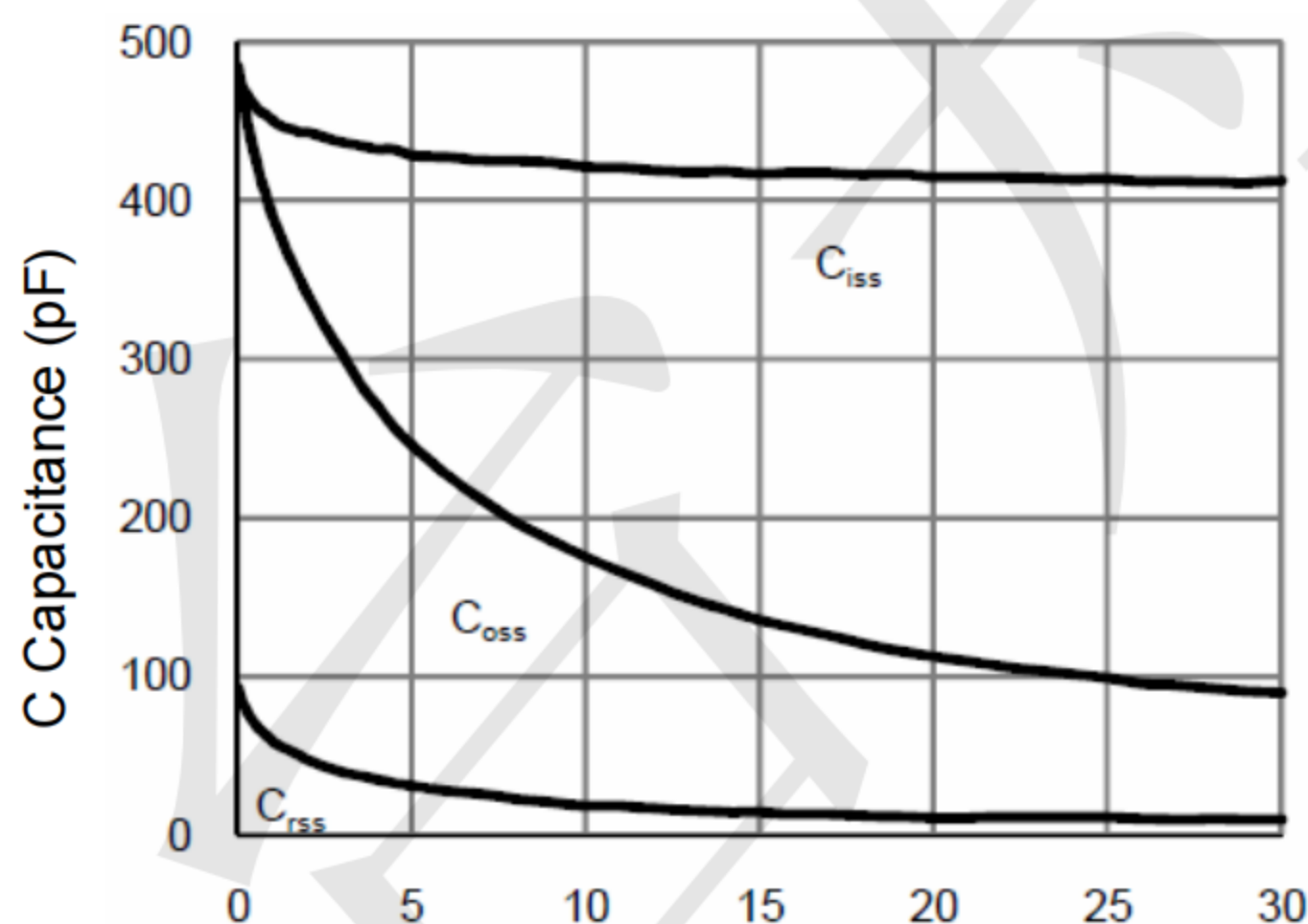

Figure 11 Capacitance vs Vds

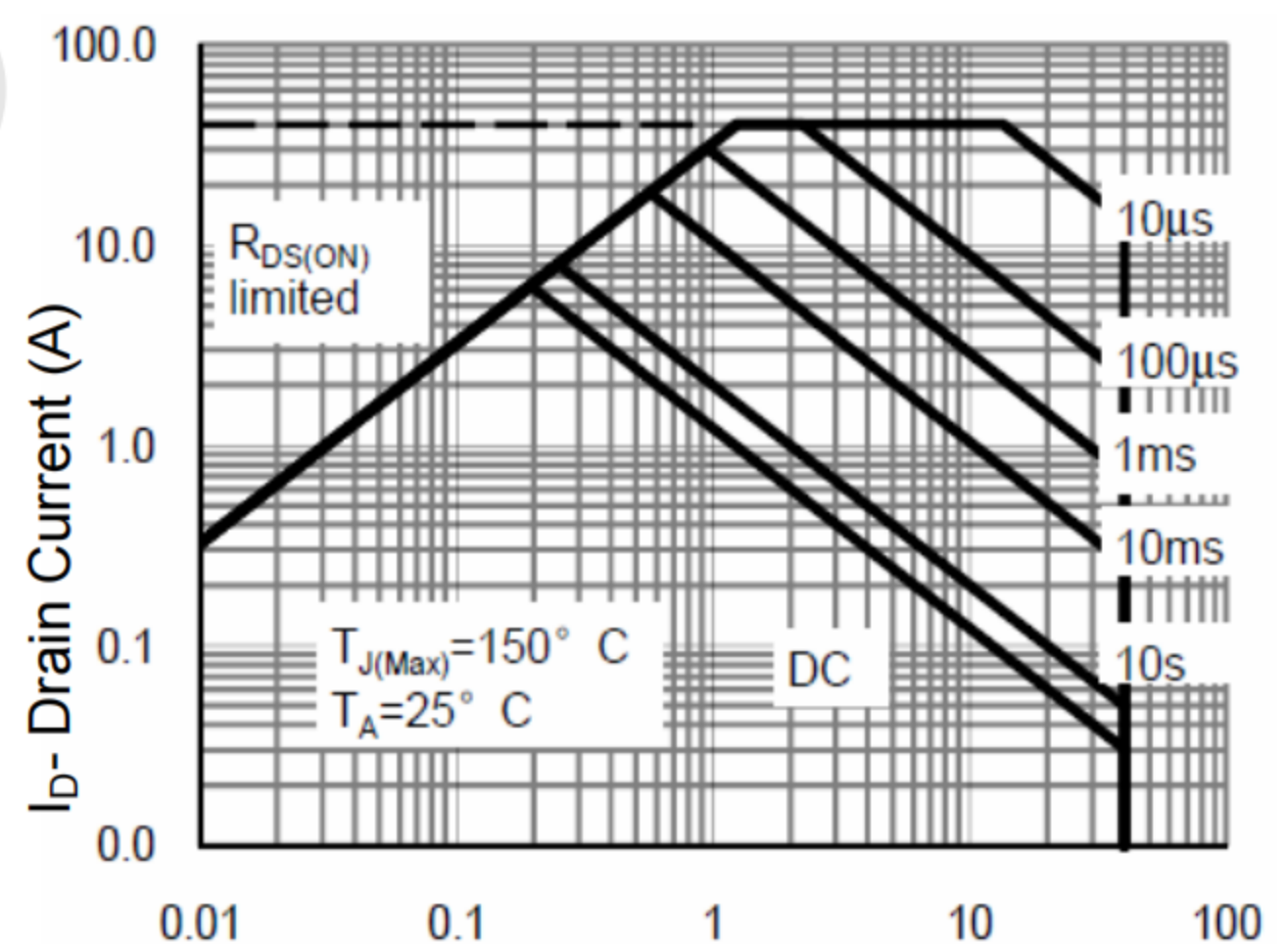

Figure 12 Safe Operation Area

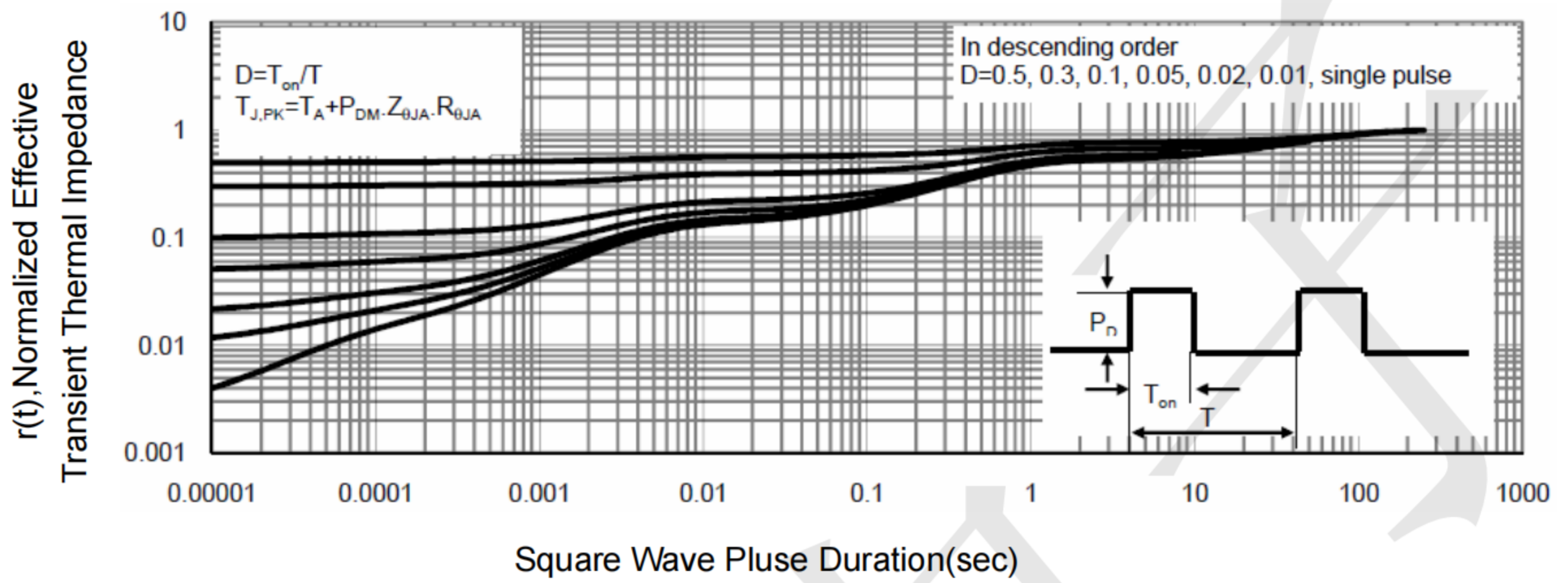

Figure 13 Normalized Maximum Transient Thermal Impedance



P- Channel Typical Electrical and Thermal Characteristics (Curves)

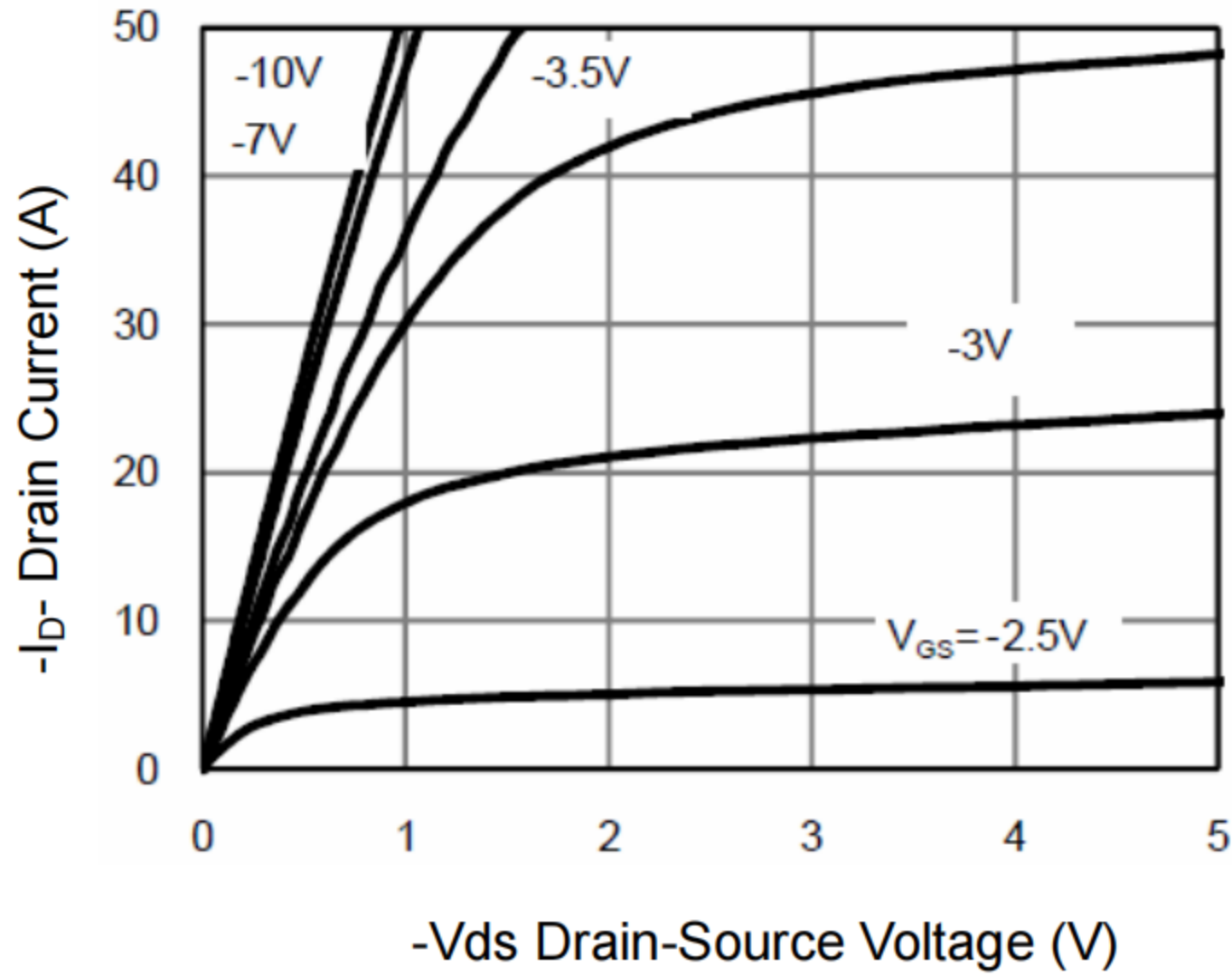

Figure 1 Output Characteristics

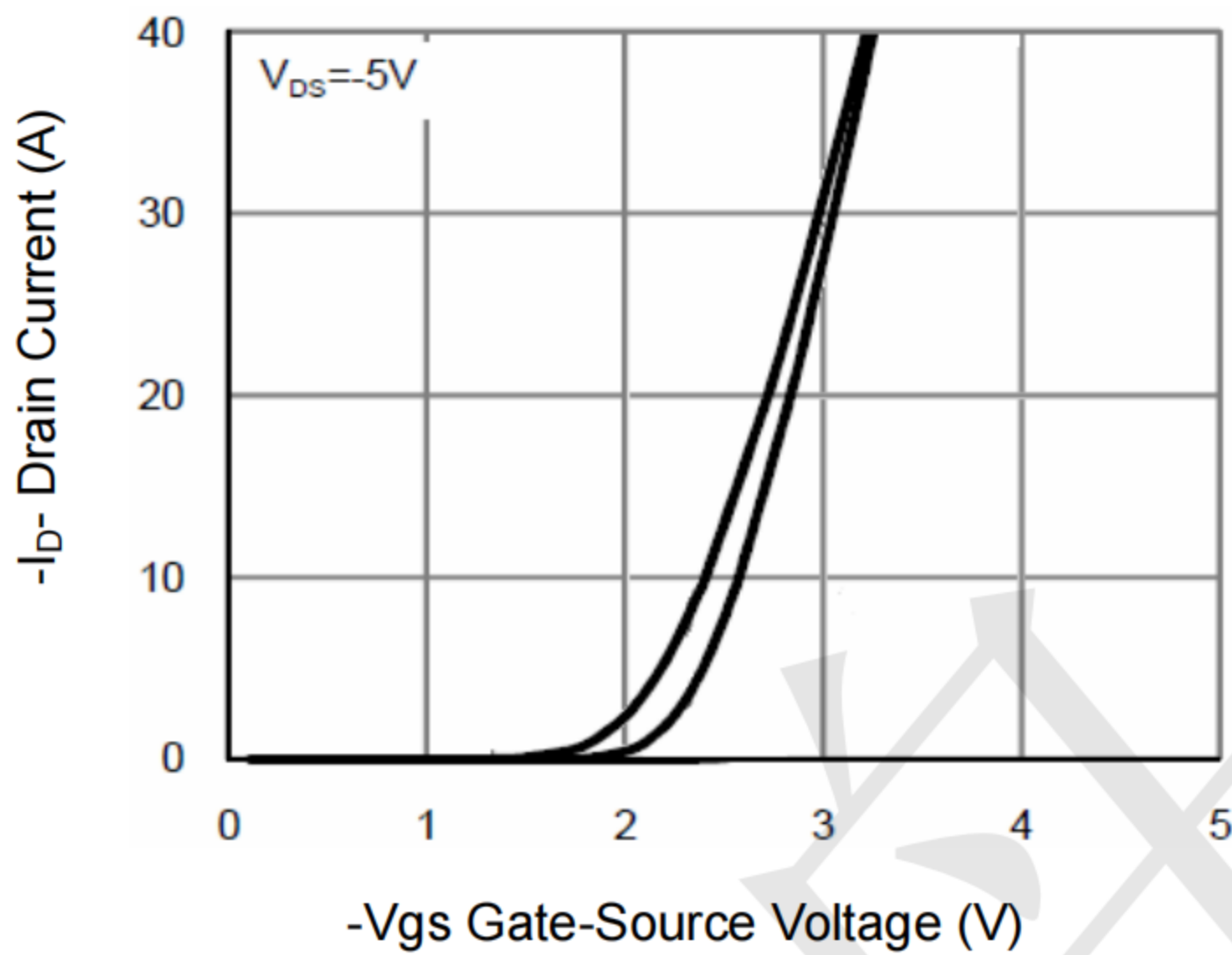

Figure 2 Transfer Characteristics

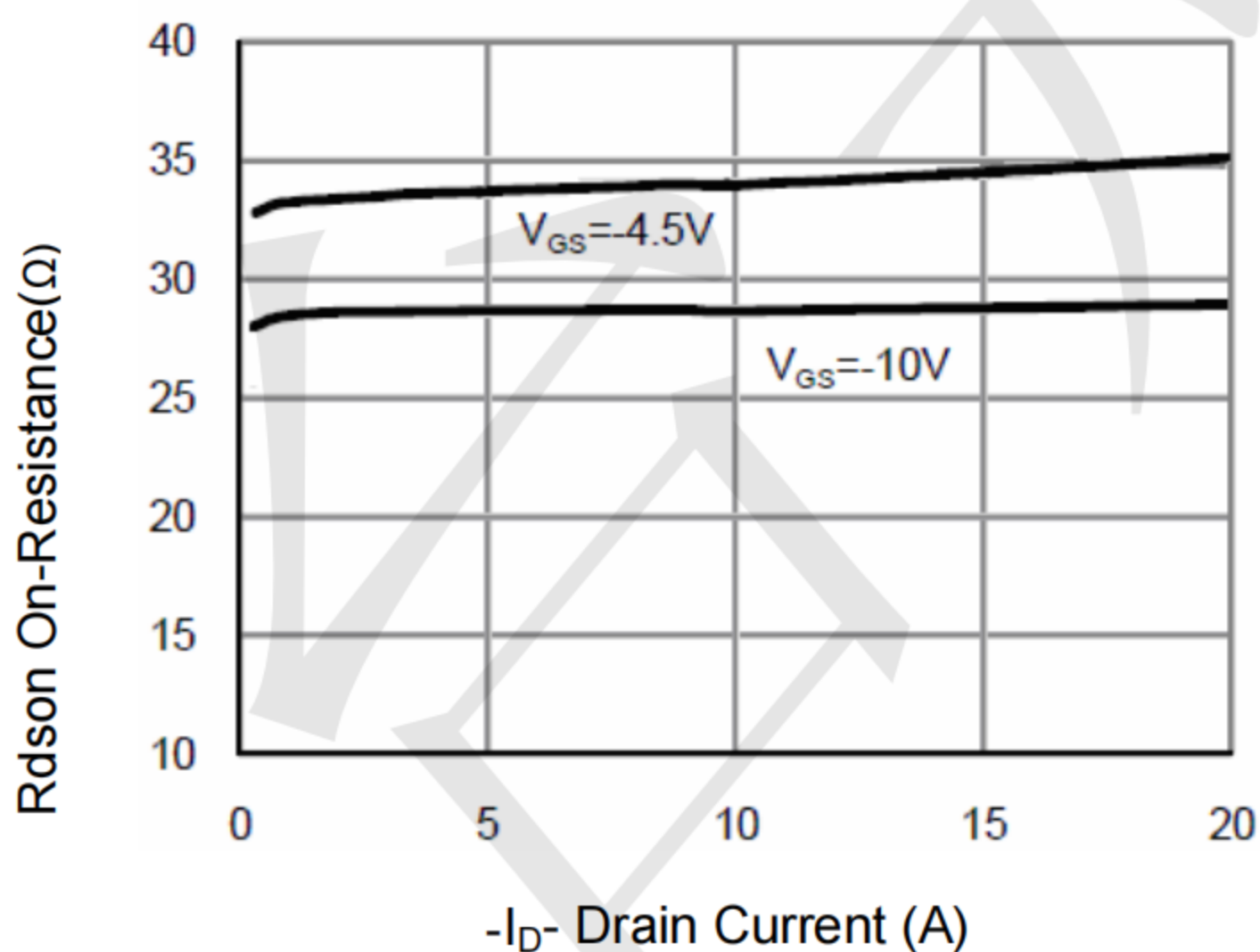

Figure 3 Rdson- Drain Current

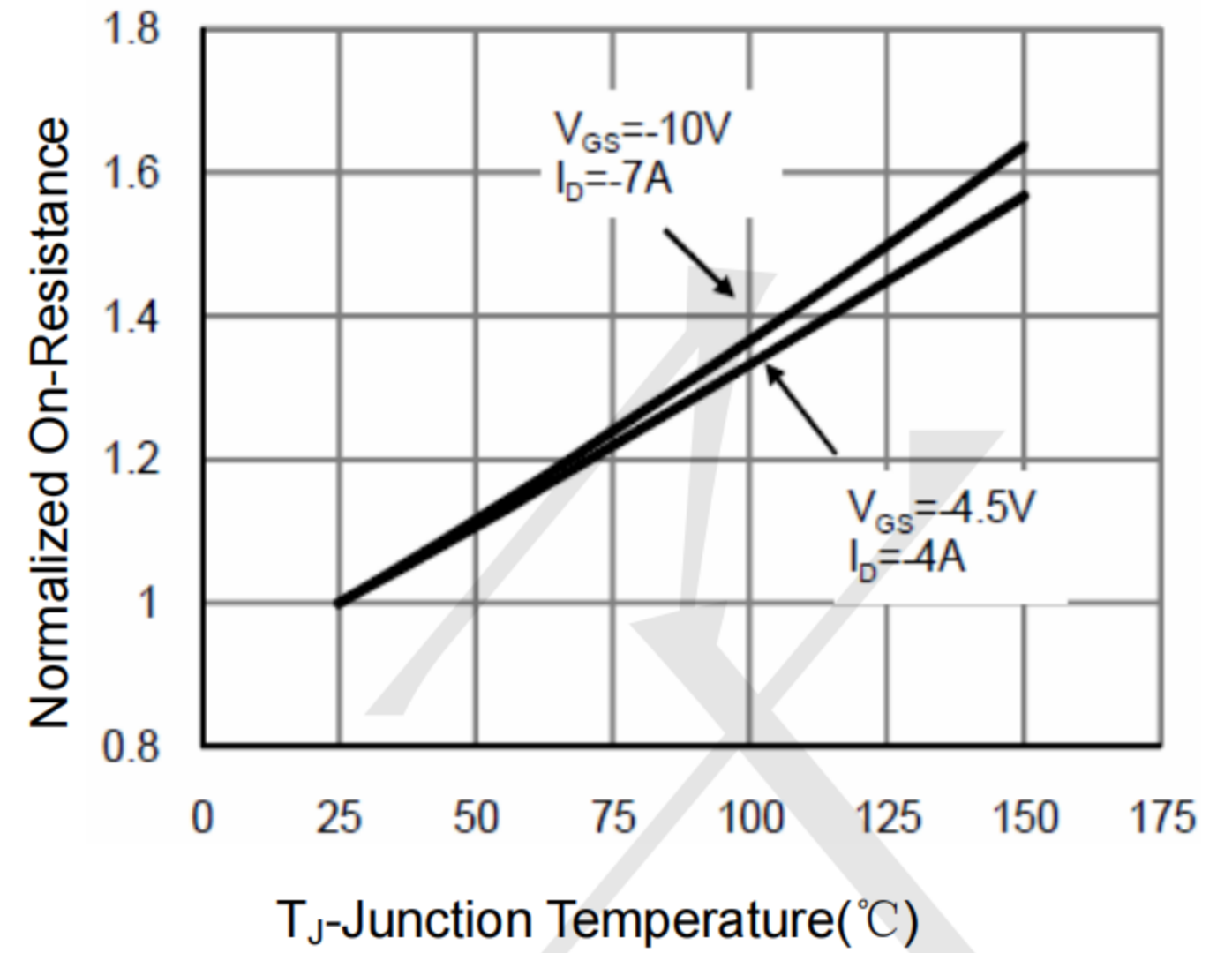

Figure 4 Rdson-Junction Temperature

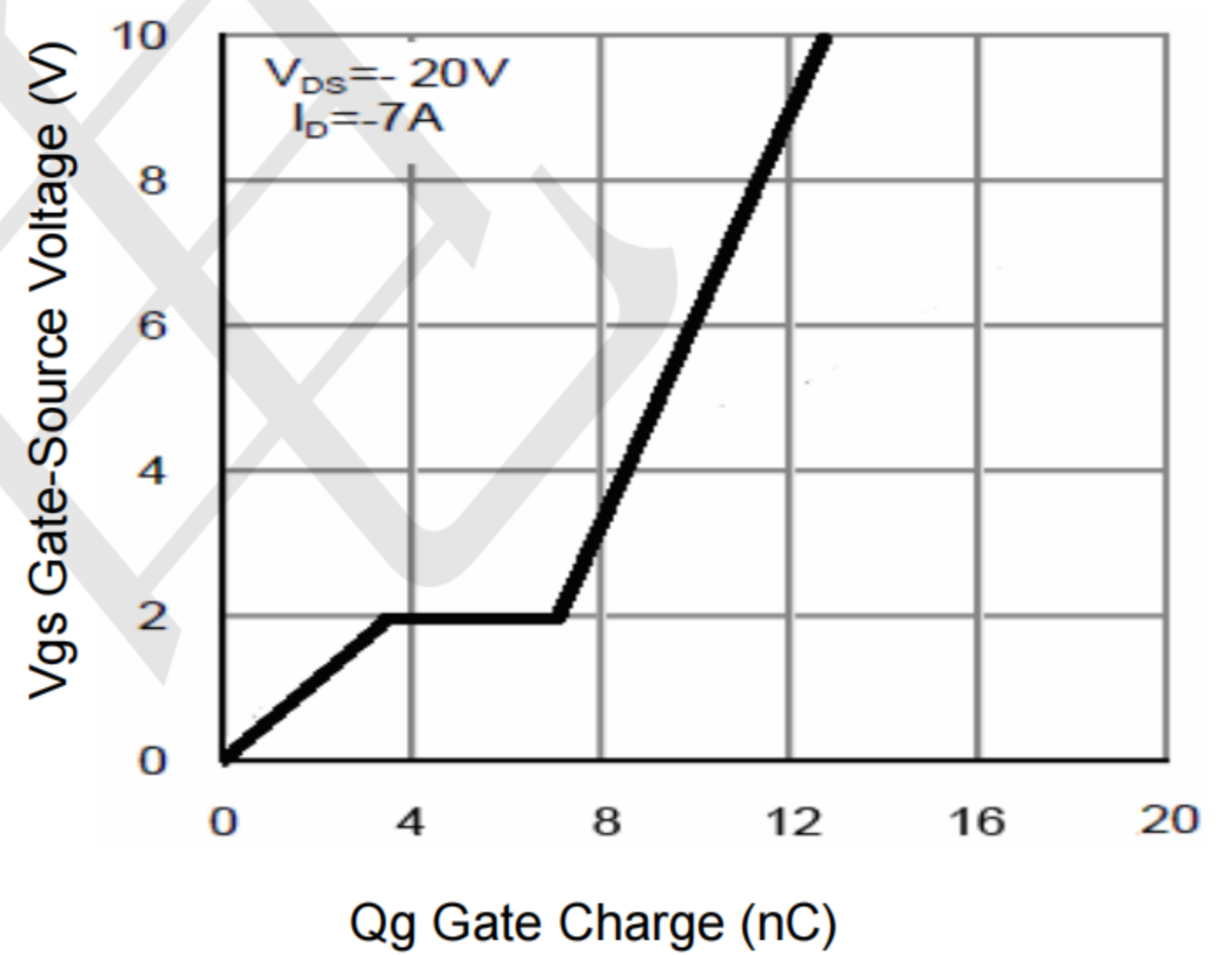

Figure 5 Gate Charge

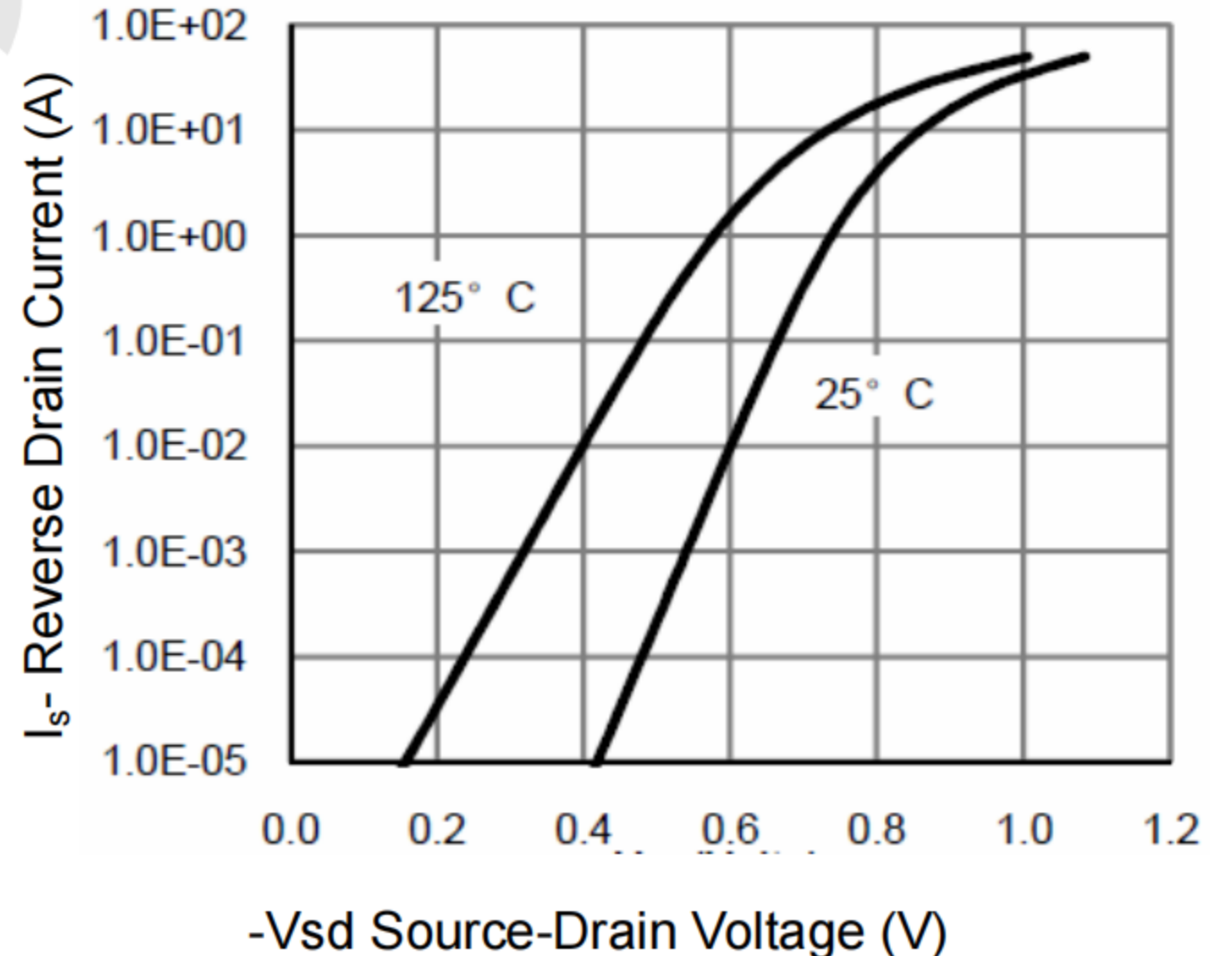
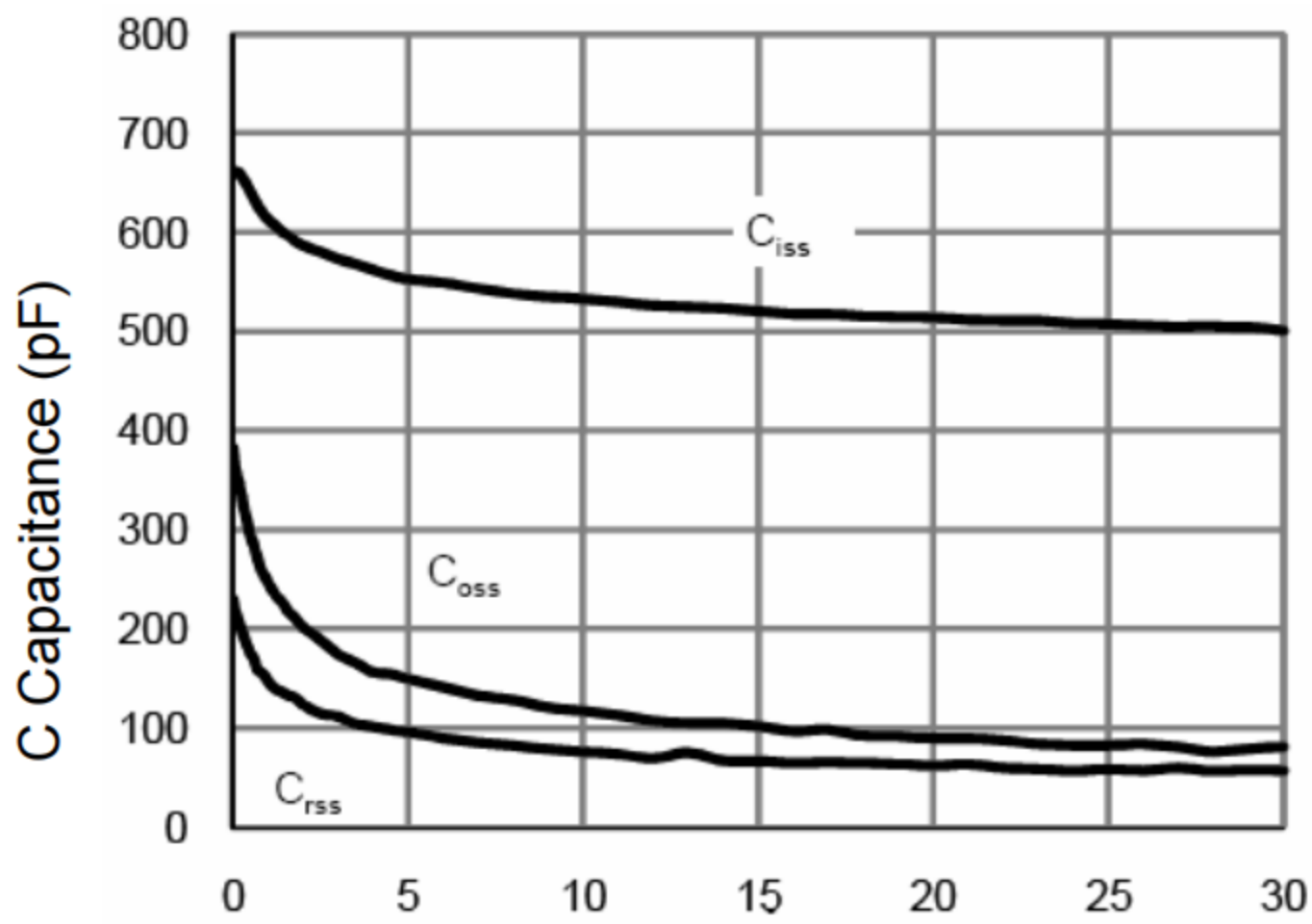
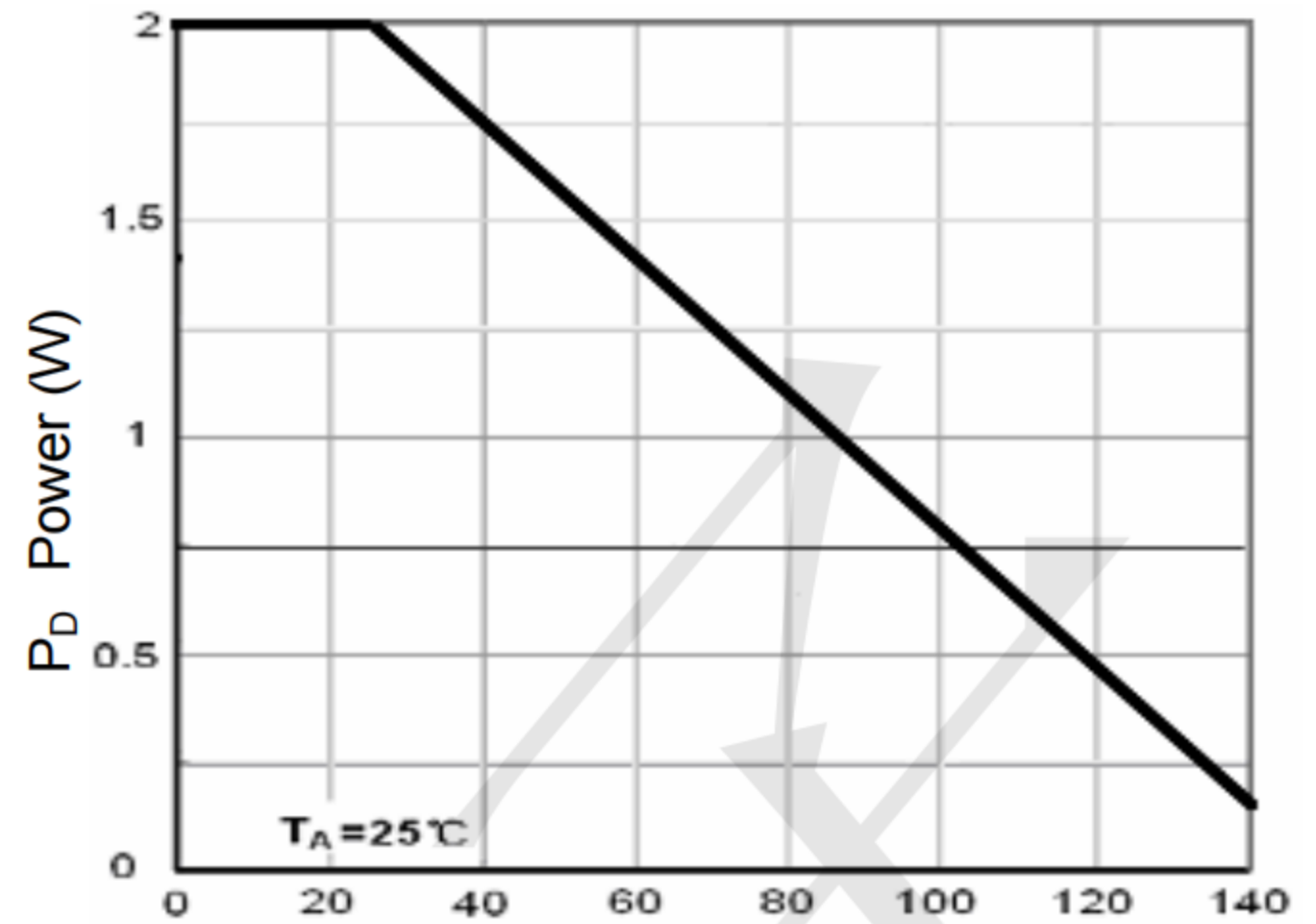

Figure 6 Source- Drain Diode Forward



-Vds Drain-Source Voltage (V)
Figure 7 Capacitance vs Vds



T_J -Junction Temperature($^{\circ}C$)
Figure 9 Power Dissipation

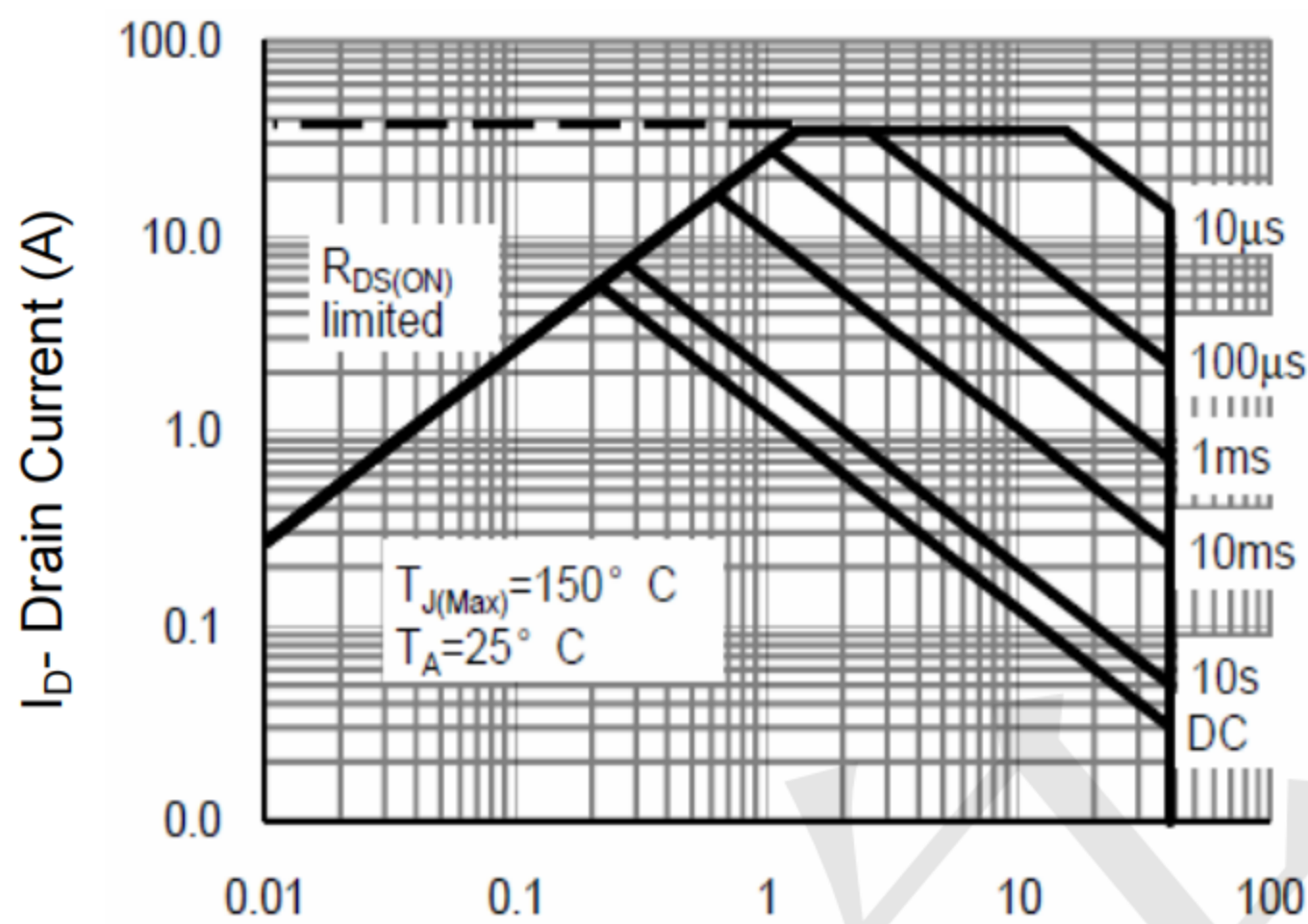

-Vds Drain-Source Voltage (V)
Figure 8 Safe Operation Area

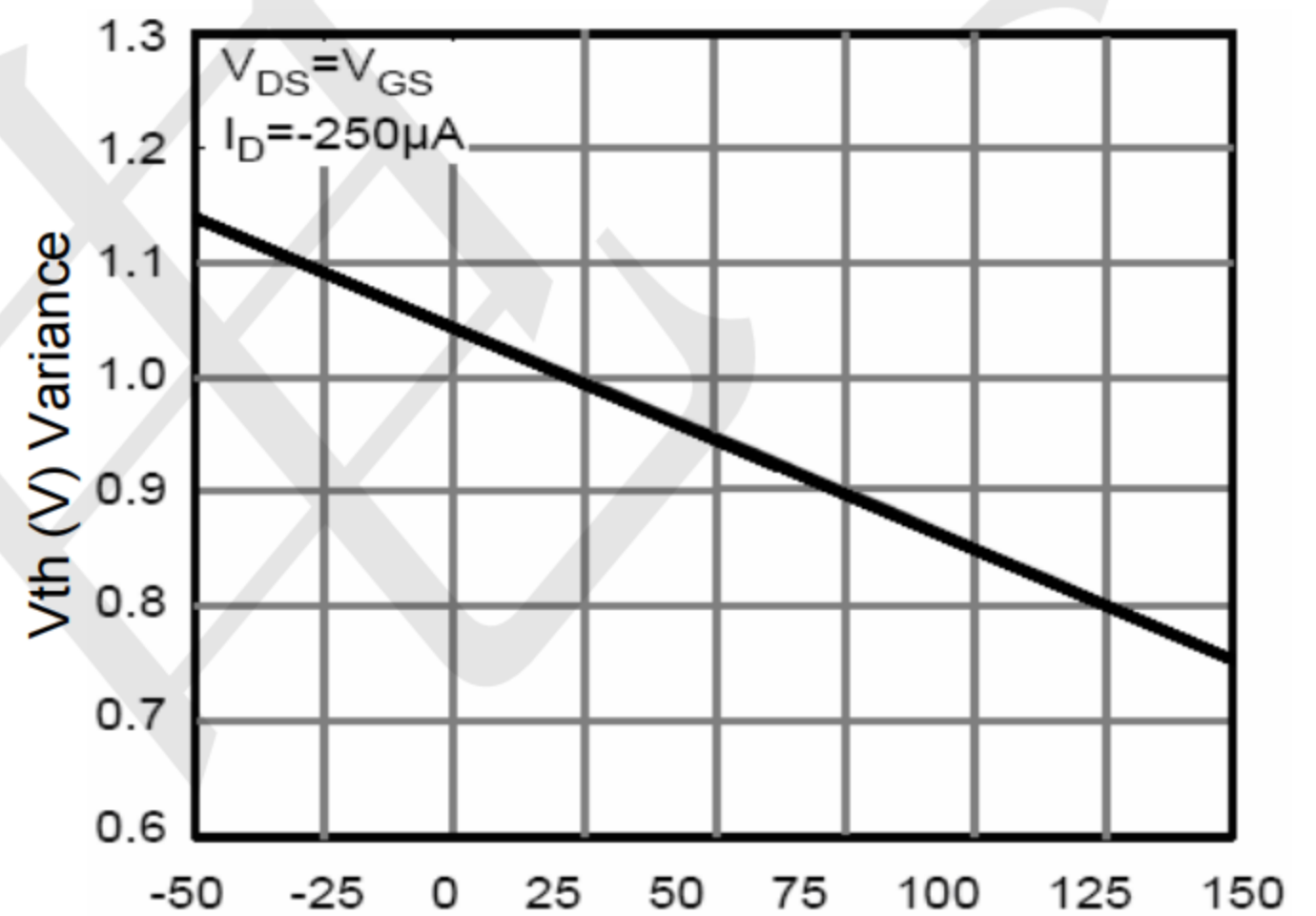

T_J -Junction Temperature($^{\circ}C$)
Figure 10 $V_{GS(th)}$ vs Junction Temperature

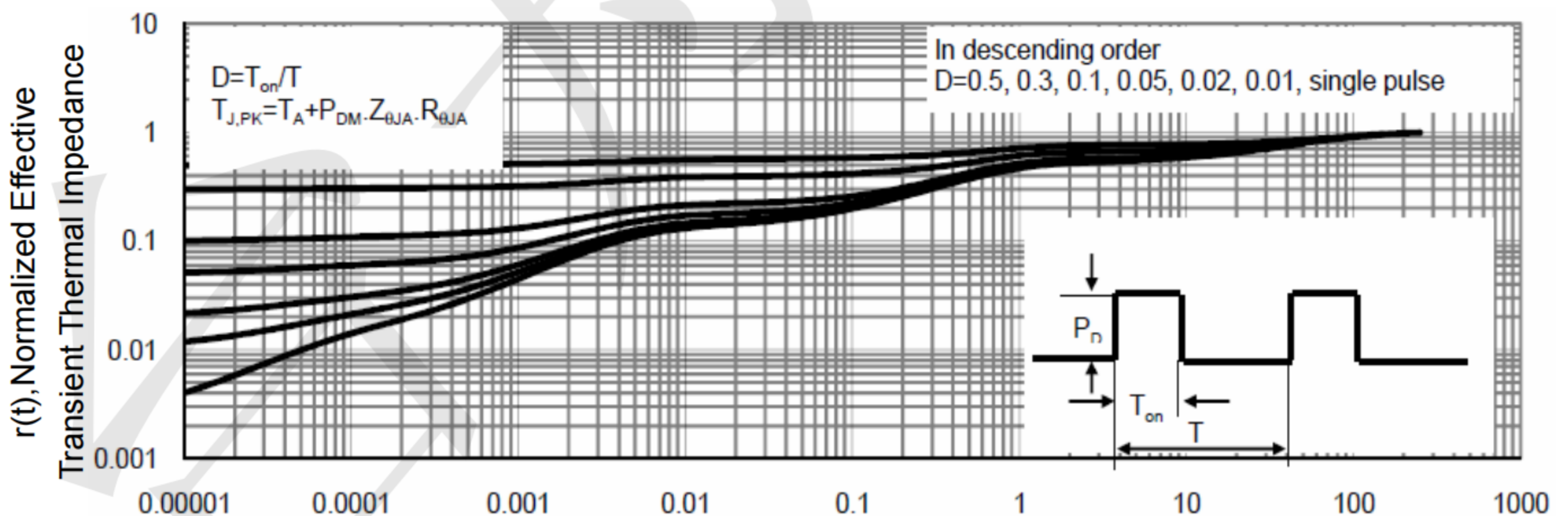

Square Wave Pulse Duration(sec)
Figure 11 Normalized Maximum Transient Thermal Impedance



TECH PUBLIC

—台丹电子—

TPM40NP8S8-1

N and P-Channel Enhancement Mode Power MOSFET

www.sot23.com.tw

SOP-8 Package Information

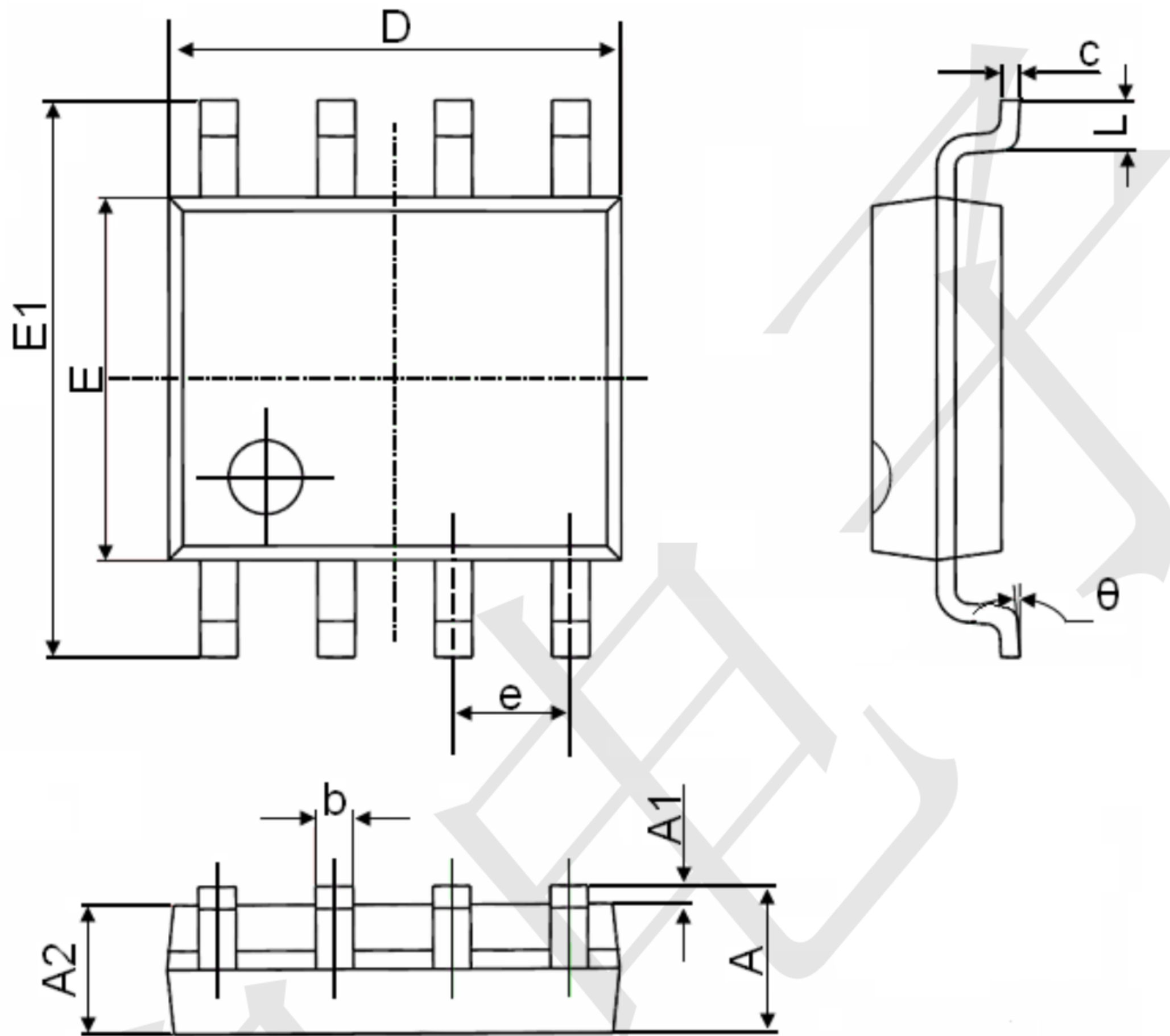

Symbol	Dimensions In Millimeters		Dimensions In Inches	
	Min.	Max.	Min.	Max.
A	1.350	1.750	0.053	0.069
A1	0.100	0.250	0.004	0.010
A2	1.350	1.550	0.053	0.061
b	0.330	0.510	0.013	0.020
c	0.170	0.250	0.006	0.010
D	4.700	5.100	0.185	0.200
E	3.800	4.000	0.150	0.157
E1	5.800	6.200	0.228	0.244
e	1.270(BSC)		0.050(BSC)	
L	0.400	1.270	0.016	0.050
θ	0°	8°	0°	8°