

## ● 特点(Features):

1. 电流转换比(CTR: 最小. 50% 工作条件  $I_F=5\text{mA}$ ,  $V_{CE}=5\text{V}$ )  
Current conversion ratio (Min 50% Working condition  $I_F=5\text{mA}$ ,  $V_{CE}=5\text{V}$ )
2. 绝缘电压: ( $V_{ISO}=5,000\text{Vrms}$ ) Insulation Voltage = 5,000Vrms,
3. 响应时间 (tr: TYP. 4 $\mu\text{s}$ ; tf: TYP. 5 $\mu\text{s}$ )工作条件  $V_{CE}=2\text{V}$ ,  $I_C=2\text{mA}$ ,  $R_L=100\ \Omega$ )  
Response Time (tr: TYP. 4 $\mu\text{s}$ ; tf: TYP. 5 $\mu\text{s}$ )working condition  $V_{CE}=10\text{V}$ ,  $I_C=2\text{mA}$ ,  $R_L=100\ \Omega$ )

## ● 说明 (Instructions)

1. 816 光耦合器的组成是: 由一个 GaAs 的发射管和一个 NPN 的晶体管组成  
816photocoupler consist of one piece of GaAs emitter and one piece of NPN transistor
2. 816 的引脚中心距是 2.54mm Pin pitch of 816 is 2.54mm
3. UL Approved :UL1577,File No.E492440

## ● 应用范围 (Application Range)

1. 开关电源.Switching power supply
2. 电表.Ammeter
3. 电脑. Computer
4. 器具的应用, 测量机. Instrumental application, measurement machine
5. 贮存器, 复印机, 自动售货机. Imbursement equipments, duplicating machine, automat
6. 家用电器, 如风扇等. Family-use electric equipments, such as fans
7. 信号传输系统. Signal transforming systems



## ● 最大绝对额定值 (常温=25°C) Max Absolute rated Value (Normal Temperature=25°C)

参数 Parameter		符号 Symbol	额定值 Rated Value	单位 Unit
输入 Inout	顺向电流 Forward Current	$I_F$	60	mA
	顺向电流峰 Peak forward current(1us pulse)	$I_{FP}$	1	A
	逆向电压 Reverse Voltage	$V_R$	6	V
	功耗率 Consume Power	P	100	mW
输出 Output	集极与射极电压 Collector and emitter Voltage	$V_{CEO}$	80	V
	射极与集极电压 Emitter and collector Voltage	$V_{ECO}$	6	
	集极电流 Collector Current	$I_C$	50	mA
	消耗功率 Consume Power	$P_C$	150	mW
总功率消耗 Total Consume Power		$P_{tot}$	200	mW
*1 绝缘电压 Insulation Voltage		$V_{iso}$	5,000	Vrms
最大绝缘电压 (绝缘油中) Max Insulation Voltage		$V_{IOTM}$	10,000	V
额定脉冲绝缘电压 Rated Impulse Insulation Voltage		$V_{IORM}$	630	V
工作温度 Working Temperature		$T_{opr}$	-55to + 110	°C
存贮温度 Deposit Temperature		$T_{stg}$	-55 to + 125	
*2 焊锡温度 Soldering Temperature		$T_{sol}$	260	

\*1. 交流测试, 时间 1 分钟, 湿度.=40~60% AC Test, 1 minute, humidity = 40~60%

如下是绝缘测试的方法. Insulation test method as below:

- (1) 将产品的两端短路。 Short circuit both terminals of photocoupler
- (2) 测试绝缘电压时无电流通过。 No Current when testing insulation voltage
- (3) 测试时加正弦波形电压。 Adding sine wave voltage when testing

\*2. 锡焊时间为 10 秒 soldering time is 10 seconds

**● 光电特性(常温=25℃) Opto-electronic Characteristics**

参数 Parameter		符号 Symbol	条件 Condition	最小 Min	中.Mid ium	最大 Max	单位 Unit
输入 Input	顺向电压 Forward Current	$V_F$	$I_F=20mA$	---	1.2	1.4	V
	逆向电流 Reverse Voltage	$I_R$	$V_R=4V$	---	---	10	$\mu A$
	集极电容 Collector capacitance	$C_t$	$V=0, f=1KHz$	---	30	250	pF
输出 Output	集极至射极电流 Collector to emitter Current	$I_{CEO}$	$V_{CE}=20V,$ $I_F=0mA$	---	---	100	nA
	集极与射极衰减电压 Collector and Emitter attenuation Voltage	$BV_{CEO}$	$I_C=0.1mA$ $I_F=0mA$	80	---	---	V
	射极与集极衰减电压 Emitter and Collector attenuation Voltage	$BV_{ECO}$	$I_E=0.1mA$ $I_F=0mA$	6	---	---	V
传输特性 Transforming Characteristics	*1 电流转换比 Current conversion ratio	CTR	$I_F=5mA$ $V_{CE}=5V$	50	---	600	%
	集极电流 Collector Current	$I_C$		2.5	---	50	mA
	集极与射极饱和电压 Collector and Emitter Saturation Voltage	$V_{CE(sat)}$	$I_F=20mA$ $I_C=1mA$	---	0.1	0.2	V
	绝缘阻抗 Insulation Impedance	$R_{iso}$	DC500V 40~60%R.H.	---	$1 \times 10^{12}$	---	$\Omega$
	电容量 capacitance	$C_f$	$V=0, f=1MHz$	---	0.6	1.0	pF
	转换频率 Transforming Frequency	$f_c$	$V_{CE}=5V,$ $I_C=2mA$ $R_L=100\Omega, -3dB$	---	80	---	kHz
	上升时间 Risetime	$t_r$	$V_{CE}=10V,$ $I_C=2mA$	---	4	18	$\mu s$
	下降时间 Descend Time	$t_f$	$R_L=100\Omega$	---	3	18	$\mu s$

● 电流转换比 Current Conversion Ratio =  $I_C / I_F \times 100\%$

● 电流转换比的等级分类 **Grades of Current conversion ratio**

等级标示 Grade Sign	最小.Min (%)	最大.Max (%)
L	50	100
A	80	160
B	130	260
C	200	400
D	300	600
L or A or B or C or D	50	600

说明：工作条件:  $I_F=5\text{mA}$ ,  $V_{CE}=5\text{V}$ ,  $T_a=25^\circ\text{C}$ .

Note: Working condition:  $I_F=5\text{mA}$ ,  $V_{CE}=5\text{V}$ ,  $T_a=25^\circ\text{C}$ .

● 外形尺寸 Outer Dimension

DIP-4

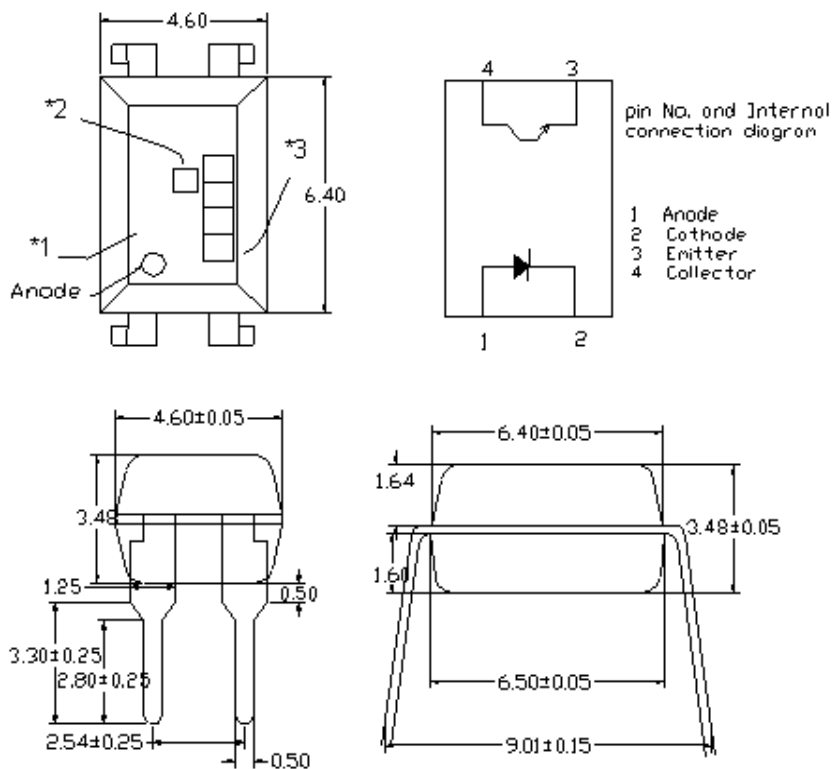

SOP-4

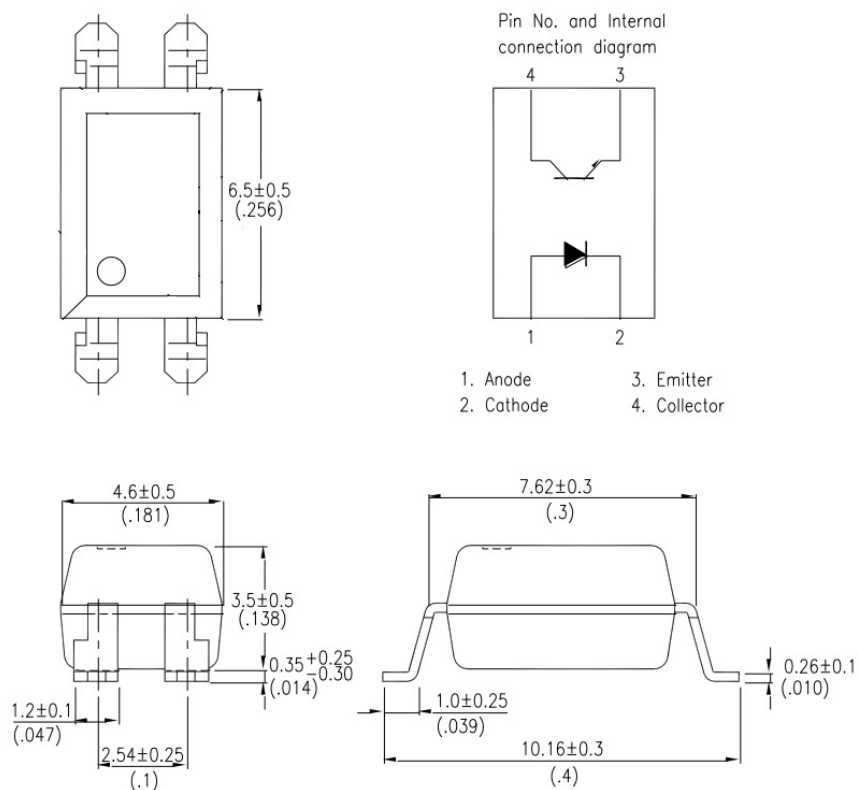

● 注解: Note

- \*1. 公司英文名. Company name
- \*2. BIN 级. Bin
- \*3. 生产周期. Production period

● 焊接温度曲线图 (Temperature Profile Of Soldering)

1. 红外回流焊 (jedec-std-020c 兼容) (IR Reflow soldering (JEDEC-STD-020C compliant))

注意：一次焊接回流建议在温度和时间配置文件如下所示的条件下。不要焊接超过三次。

配置项	条件
预热 (Preheat)	
-最低温度 (TSmin )	150°C
-最高温度 (TSmax )	200°C
-时间 (最小到最大 (TS))	90±30 sec
焊接区 (Soldering zone)	
-温度 (T <sub>L</sub> )	217°C
-时间 (t <sub>L</sub> )	60 sec
峰值温度 (Peak Temperature)	260°C
爬升率 (Ramp-up rate)	3°C / sec max.
下降率 (3°C / sec max.)	3~6°C / sec

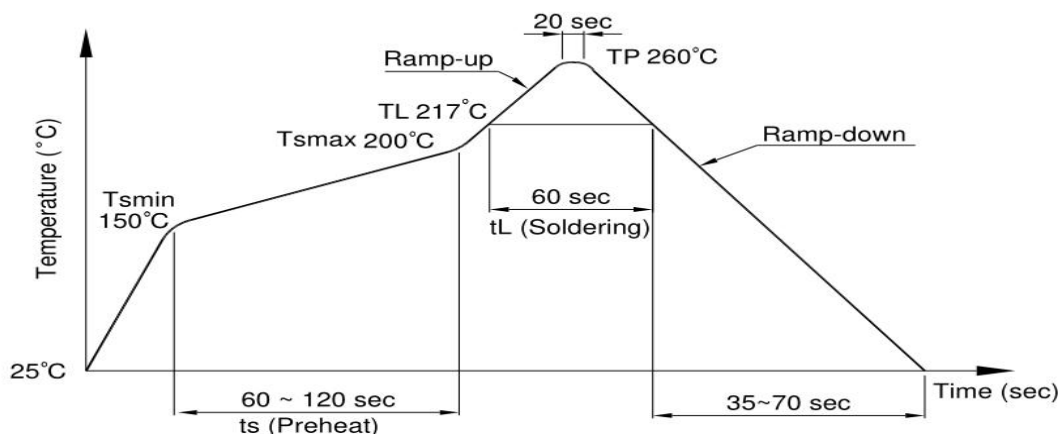

**2. 超声波焊接 (jedec22a111 兼容) (Wave soldering (JEDEC22A111 compliant))**  
 建议在温度条件下一致性焊接。

温度 (Temperature)	260+0/-5°C
时间 (Time)	10 sec
预热温度 (Preheat temperature)	5 to 140°C
预热时间 (Preheat time)	30 to 80 sec

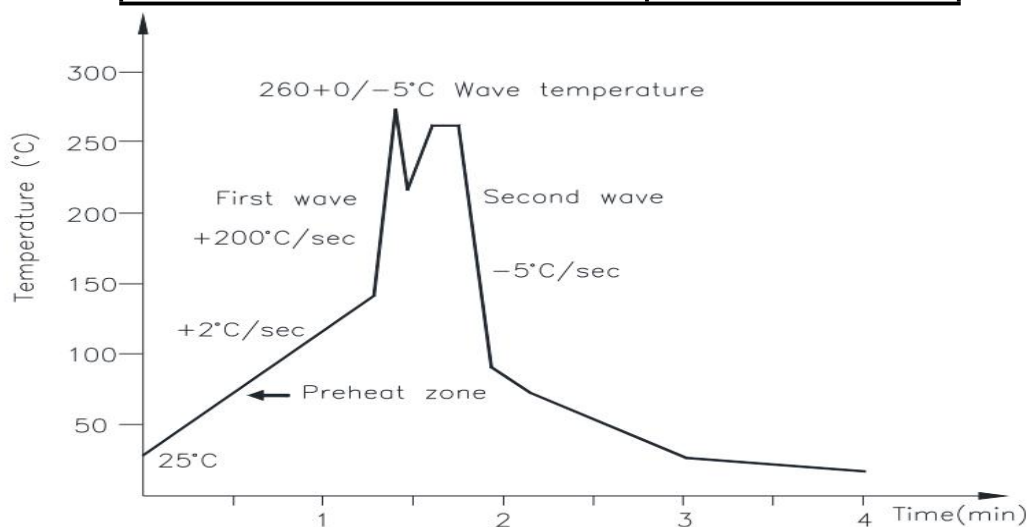

**3. 电烙铁手工焊接 (Hand soldering by soldering iron)**

允许单铅焊接在每一个过程中, 建议一次性焊接。

温度 (Temperature)	380+0/-5°C
时间 (Time)	3 sec max

● 特性曲线 Characteristics Curve

Fig.1 Forward Current vs. Ambient Temperature

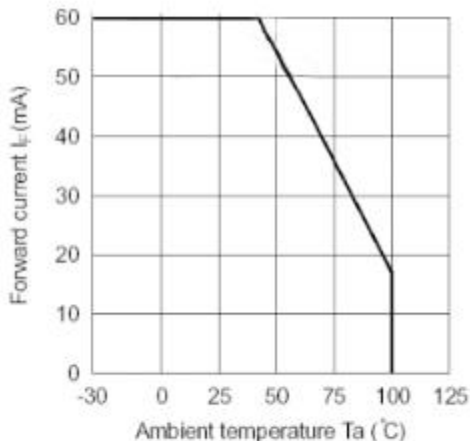

Fig.2 Collector Power Dissipation vs. Ambient Temperature

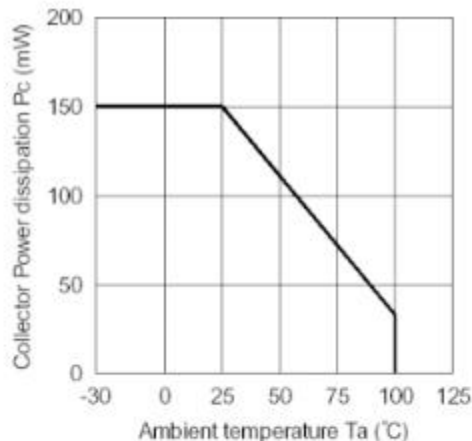

Fig.3 Collector-emitter Saturation Voltage vs. Forward Current

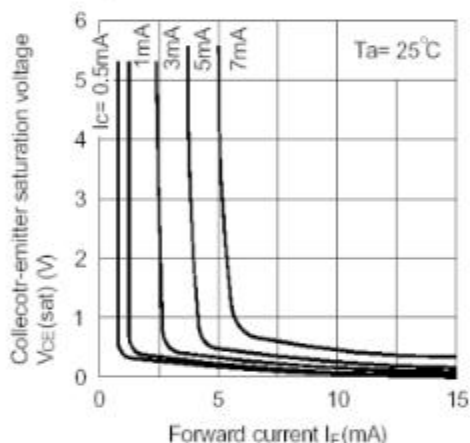

Fig.4 Forward Current vs. Forward Voltage

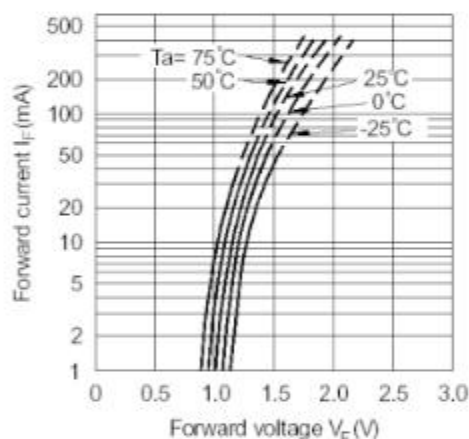

Fig.5 Current Transfer Ratio vs. Forward Current

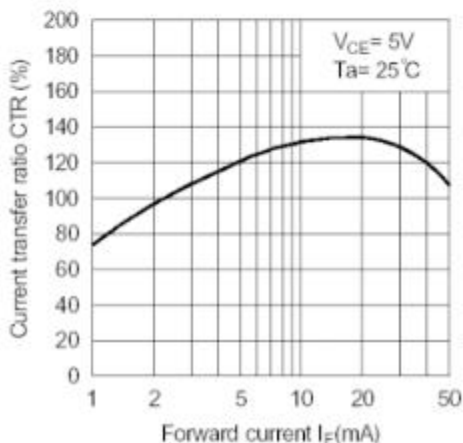
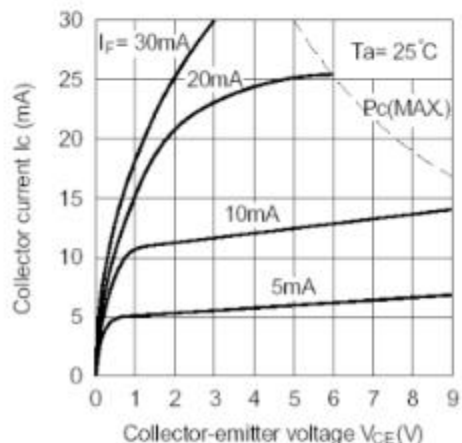

Fig.6 Collector Current vs. Collector-emitter Voltage



● 特性曲线 Characteristics Curve

Fig.7 Relative Current Transfer Ratio vs. Ambient Temperature

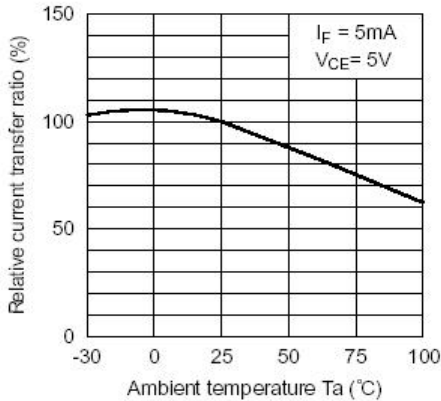

Fig.8 Collector-emitter Saturation Voltage vs. Ambient Temperature

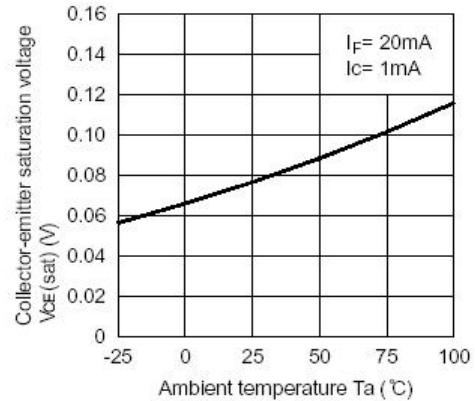

Fig.9 Collector Dark Current vs. Ambient Temperature

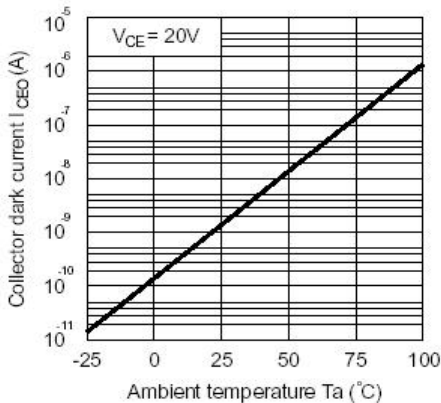

Fig.10 Response Time vs. Load Resistance

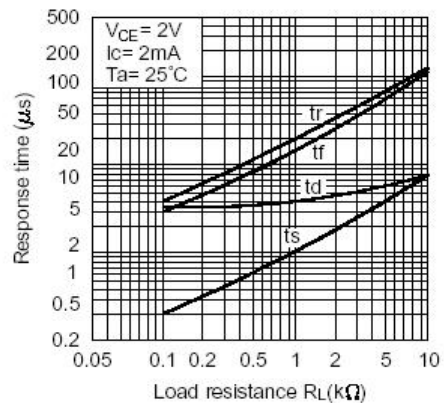
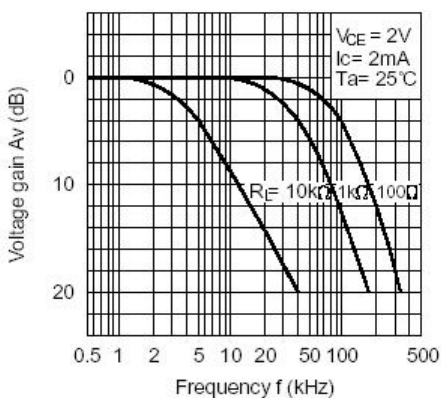
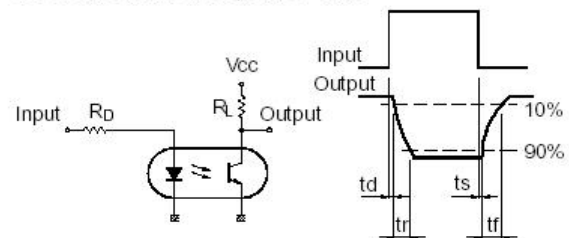

Fig.11 Frequency Response



Test Circuit for Response Time



Test Circuit for Frequency Response

