

MAPX	MODIFICATION	DATE	DRAW	APPROVE

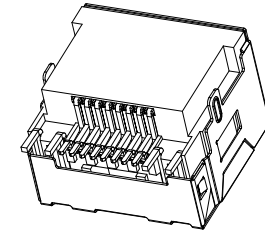
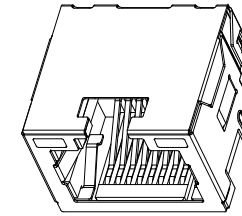
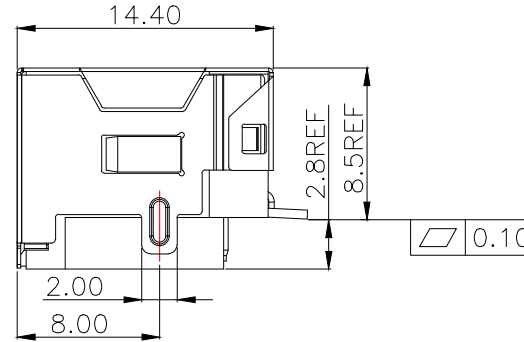
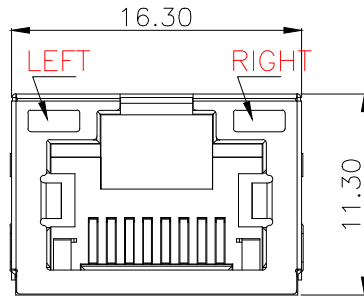

NOTES

MATERIAL

- 1.HOUSING MATERIAL: THERMO PLASTICS UL94V-0.
- 2.CONTACT MATERIAL: PHOSPHOR BRONZE T=0.3.
- 3.PLATING: GOLD PLATING ON CONTACT AREA TIN PLATED ON SOLDER AREA, NICKEL PLATD OVER ALL.
- 4.SHIELD: BRASS T=0.20mm WITH NICKEL PLATED.

ELECTRICAL

- 1.VOLTAGE RATING: 125 VAC RMS.
- 2.CURRENT RATING: 1.5 AMP.
- 3.CONTACT RESISTANCE: 40 MILLIOHMS MAX.
- 4.INSULATION RESISTANCE: 500 MEGOHMS MIN @ 100V DC .
- 5.DIELECTRIC DIELECTRIC RESISTANCE: 500V DC RMS 50Hz. 1MIN.

MECHANICAL

- 1.DURRABILITY: 750 CYCLES MIN.
2. MATING/UNMATING FORC: 2.24 KG.F MAX.

ENVIRONMENTAL:

- 1.OPERATION: -40℃~+85℃.
- 2.STORAGE: -40℃~+85℃.

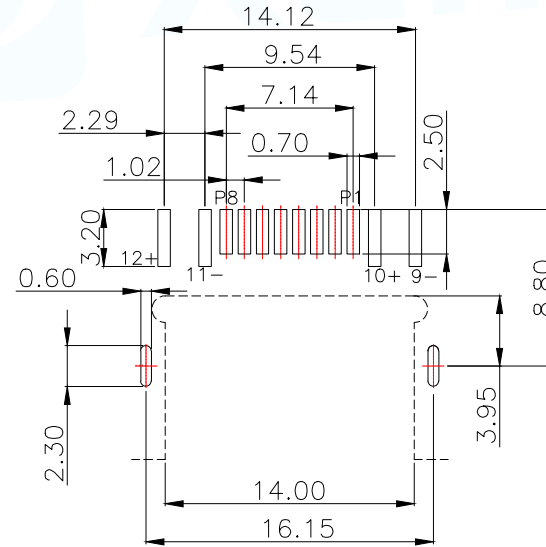
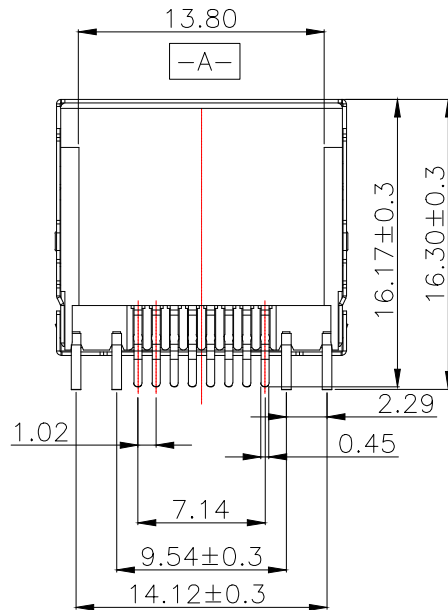
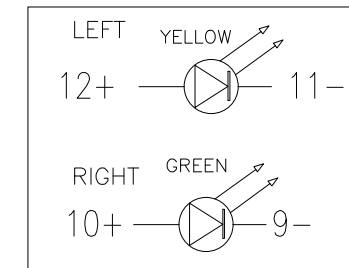

PCB LAYOUT
TOL:±0.05

MANUFACTURE DWG		东莞市讯普电子科技有限公司 DongGuan XunPu Electronics Co.,Ltd	
UNLESS OTHERWISE SPECIFIED TOLERANCES			TITLE: RJ45 沉板8.5 SMT 有壳左黄右绿
			PAR RJ45-001-020-11
DECIMALS:	ANGLES:		DWN
.X:±0.35	X':±3'		CHKD
.XX:±0.25	.X':±2'	APVD	
.XXX:±0.15	.XX':±1'	CUSTOMER COPY	SCALE 1:1 UNIT:MM
		SIZE:A4	SHEET:1F1
			REV:A