



- ⊗ IP68 when mated, Tested in accordance with EN60529:1992+A2:2013
- ⊗ IP69K when mated, Tested in accordance with DIN 40050/Part 9 IP69k
- ⊗ EN60068-2-52 Test Kb Salt Mist (Cyclic) Marine Severity Level 1
- ⊗ Secure, proven & reliable screw locking mechanism
- ⊗ PUR / PVC Jacket on cable
- ⊗ Chemical resistance & flame retardant
- ⊗ Cat 8 toolless Keystone IDC connector
- ⊗ Data rates up to 25Gbps
- ⊗ Backwards compatibility throughout
- ⊗ Cat 5e or Cat 6a Shielded coupler
- ⊗ Rewireable Flex connector up to Cat 6a
- ⊗ Field termination up to Cat 6a
- ⊗ Earth lead version of panel mounting coupler
- ⊗ Cat 5e PCB Mount & IDC termination panel connector
- ⊗ High noise immunity, full shielding and EMI protection
- ⊗ Power over Ethernet (PoE) compliant

Patch Cord Flex Connector



PX0836

- Mates with all panel mounting connectors
- Patchcords with IP68 connector
- Supplied with shielded RJ45 plug
- Single or double end terminated
- Standard lengths: 2m, 3m & 5m
- S-FTP cable construction
- PUR (Cat 5e) or PVC (Cat 6a / 8) jacket cable
- Wiring configuration to 568-B

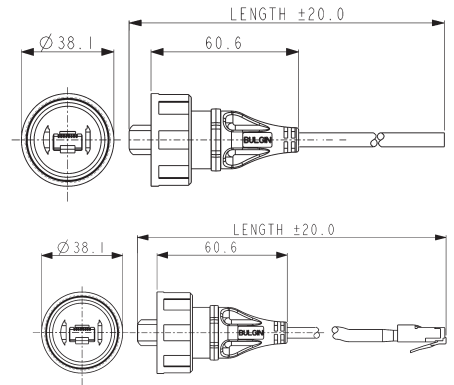

Part no.	Type	Length	Description
PX0836/2M00	Wire end	2m	Cat 5e IP68 RJ45 Buccaneer to bare end
PX0836/3M00	Wire end	3m	Cat 5e IP68 RJ45 Buccaneer to bare end
PX0836/5M00	Wire end	5m	Cat 5e IP68 RJ45 Buccaneer to bare end
PX0837/2M00	Single ended	2m	Cat 5e IP68 RJ45 Buccaneer to Shielded RJ45
PX0837/3M00	Single ended	3m	Cat 5e IP68 RJ45 Buccaneer to Shielded RJ45
PX0837/5M00	Single ended	5m	Cat 5e IP68 RJ45 Buccaneer to Shielded RJ45
PX0838/2M00	Double ended	2m	Cat 5e IP68 RJ45 Buccaneer to IP68 RJ45 Buccaneer
PX0838/3M00	Double ended	3m	Cat 5e IP68 RJ45 Buccaneer to IP68 RJ45 Buccaneer
PX0838/5M00	Double ended	5m	Cat 5e IP68 RJ45 Buccaneer to IP68 RJ45 Buccaneer
PX0896/2M00	Wire end	2m	Cat 6a IP68 RJ45 Buccaneer to bare end
PX0896/3M00	Wire end	3m	Cat 6a IP68 RJ45 Buccaneer to bare end
PX0896/5M00	Wire end	5m	Cat 6a IP68 RJ45 Buccaneer to bare end
PX0897/2M00	Single ended	2m	Cat 6a IP68 RJ45 Buccaneer to Shielded RJ45
PX0897/3M00	Single ended	3m	Cat 6a IP68 RJ45 Buccaneer to Shielded RJ45
PX0897/5M00	Single ended	5m	Cat 6a IP68 RJ45 Buccaneer to Shielded RJ45
PX0898/2M00	Double ended	2m	Cat 6a IP68 RJ45 Buccaneer to IP68 RJ45 Buccaneer
PX0898/3M00	Double ended	3m	Cat 6a IP68 RJ45 Buccaneer to IP68 RJ45 Buccaneer
PX0898/5M00	Double ended	5m	Cat 6a IP68 RJ45 Buccaneer to IP68 RJ45 Buccaneer
PX0857/2M00	Single ended	2m	Cat 8 IP68 RJ45 Buccaneer to IP68 Shielded RJ45
PX0857/3M00	Single ended	3m	Cat 8 IP68 RJ45 Buccaneer to IP68 Shielded RJ45
PX0857/5M00	Single ended	5m	Cat 8 IP68 RJ45 Buccaneer to IP68 Shielded RJ45
PX0858/2M00	Double ended	2m	Cat 8 IP68 RJ45 Buccaneer to IP68 RJ45 Buccaneer
PX0858/3M00	Double ended	3m	Cat 8 IP68 RJ45 Buccaneer to IP68 RJ45 Buccaneer
PX0858/5M00	Double ended	5m	Cat 8 IP68 RJ45 Buccaneer to IP68 RJ45 Buccaneer

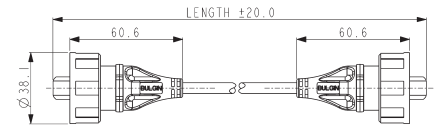

Re Wireable Flex Connector



PX0834

- Mates with all panel mounting connectors
- Supplied with shielded RJ45 plug
- Two versions:
- Cat 5e or Cat 6a Cable size from 5 to 6mm diameter, or extra cable glands for other cable sizes from 3.5 to 8mm diameter.

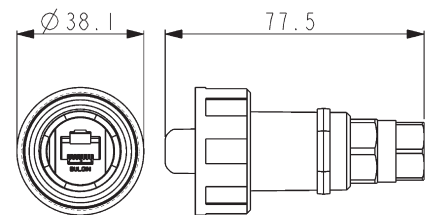

Part no.	Description
PX0834/A	Cat 5e suitable for use with cables from 5 to 6mm diameter
PX0834/B	Cat 5e with 2 extra cable glands, suitable for use with cables from 3.5 to 8mm diameter
PX0894/A	Cat 6a suitable for use with cables from 5 to 6mm diameter
PX0894/B	Cat 6a with 2 extra cable glands, suitable for use with cables from 3.5 to 8mm diameter

Front Panel Mounting Coupler Connector



PX0833

- Cat 5e mates with PX0836, PX0837, PX0838 & PX0834 flex connectors
- Cat 6a mates with PX0896, PX0897, PX0898 & PX0894 flex connectors
- Standard RJ45 patchcord can be plugged into rear
- Version with earth wire available
- Single hole fixing
- Complete with panel sealing gasket

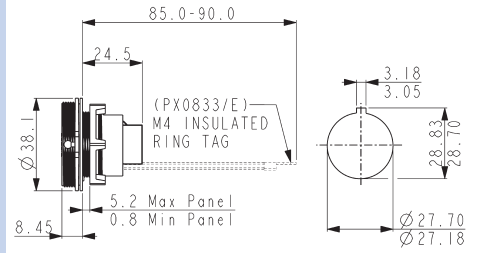

Part no.	Description	Fixing
PX0833	Cat 5e coupler	Front panel mounted
PX0833/E	Cat 5e coupler + earth wire	Front panel mounted
PX0893	Cat 6a coupler	Front panel mounted
PX0893/E	Cat 6a coupler + earth wire	Front panel mounted

Front Panel Mounting Keystone Connector



PX0855/KS

- Backwards compatible with all flex connectors
- Cat 8 mates with PX0857, PX0858 flex connectors
- Toolless jack termination
- Maintains shielding ground continuity
- Single hole fixing
- Complete with panel sealing gasket

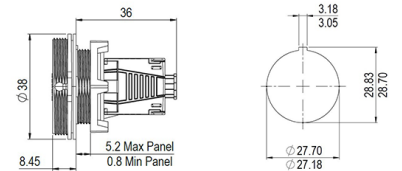

Part no.	Description	Fixing
PX0855/KS	Cat 8 Keystone connector	Front panel mounted

Rear Panel Mounting Keystone Connector



PX0856/KS

- Backwards compatible with all flex connectors
- Cat 8 mates with PX0857, PX0858 flex connectors
- Toolless jack termination
- Maintains shielding ground continuity
- Single hole fixing
- Complete with panel sealing gasket

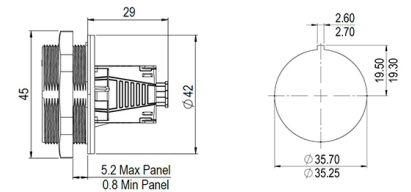

Part no.	Description	Fixing
PX0856/KS	Cat 8 Keystone connector	Rear panel mounted

Flange Mounting Connector



PX0870

- Cat 5e mates with PX0836, PX0837, PX0838 & PX0834 flex connectors
- Cat 6a mates with PX0896, PX0897, PX0898 & PX0894 flex connectors
- Standard RJ45 patchcord can be plugged into rear
- Version with earth wire available
- Flange fixing
- Complete with panel sealing gasket

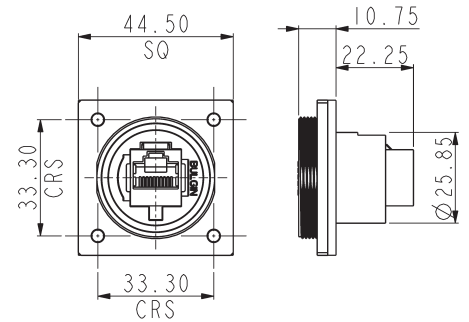

Part no.	Description	Fixing
PX0870	Cat 5e coupler	Flange mounting
PX0870/E	Cat 5e coupler + earth wire	Flange mounting
PX0890	Cat 6a coupler	Flange mounting
PX0890/E	Cat 6a coupler + earth wire	Flange mounting

PCB Mounting Connector



PX0839/PC

- Cat 5e shielded RJ45 interface
- Rear of panel mounted
- Mates with PX0836, PX0837, PX0838 and PX0834 flex connectors
- For direct vertical mounting to PCB, straight Plugs
- Complete with panel sealing PX0839/PC gasket

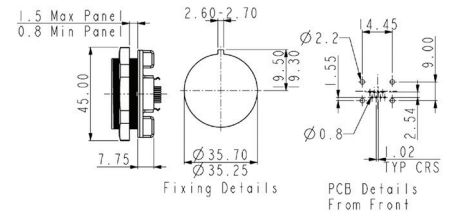

Part no.	Description	Fixing
PX0839/PC	Cat 5e connector - PC	Rear panel mounted

PCB Mounting Connector



PX0839/90

- Cat 5e shielded RJ45 interface
- Rear of panel mounted
- Mates with PX0836, PX0837, PX0838 and PX0834 flex connectors
- For direct horizontal mounting to PCB, 90° Plugs
- Complete with panel sealing PX0839/90 gasket

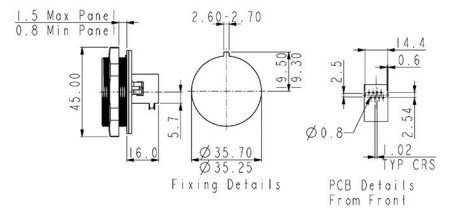

Part no.	Description	Fixing
PX0839/90	Cat 5e connector - 90 degree Plugs	Rear panel mounted

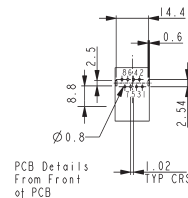

Panel Mounting Connector



PX0839/IDC

- Cat 5e shielded RJ45 interface
- Rear of panel mounted
- Mates with PX0836, PX0837, PX0838 and PX0834 flex connectors
- Two IDC blocks for discrete termination
- Complete with panel sealing

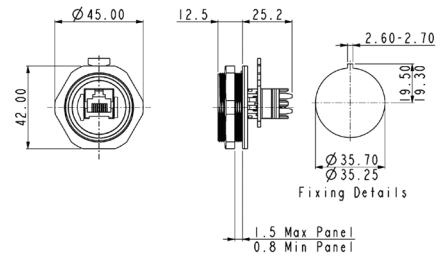

Part no.	Description	Fixing
PX0839/IDC	Cat 5e coupler - IDC	Rear panel mounted

Shield Back Shell Accessory



PX0888

- Maintains RJ45 coupler screening directly to panel
- Shielding can is fixed to rear of panel mount connector
- For use on PX0833, PX0893 & PX0855

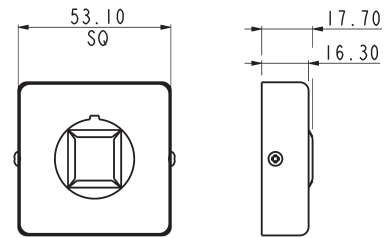

Part no.	Description
PX0888	Shielding backshell accessory

Accessories



Sealing Caps

- Sealing caps to maintain IP68 rating when connectors are not in use
- Replacement shielded RJ45s
- Hand crimp tool for shielded RJ45
- Patch cord cable available in 50m reels

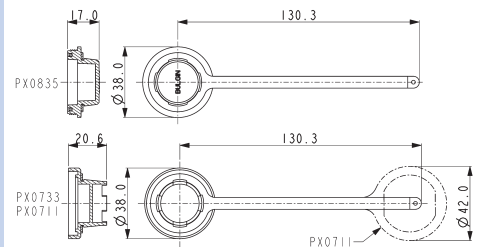

Part no.	Description
PX0835	Sealing Cap for use on all ethernet flex connectors
PX0733	Sealing Cap for use on all front panel mounting connectors
PX0711	Sealing Cap for use on all rear panel mounting connectors
14151	Cat 5e & Cat 6a Hand crimp tooling + die set
14199	Cat 5e PUR Jacket Cable - 50m reel
14150	Cat 5e Replacement shielded RJ45
15241	Cat 6a PVC Jacket Cable - 50m reel

Connectors	Cat 5e & 6a	Cat 8
Sealing:	IP68, EN60529:1992+A2:2013 (10m depth for 2 weeks)	IP68, EN60529:1992+A2:2013 (10m depth for 2 weeks)
	IP69K, Tested in accordance with DIN 40050/Part 9 IP6k9k	IP69K, Tested in accordance with DIN 40050/Part 9 IP6k9k
Operating Temperature:	-20°C to +70°C	-20°C to +60°C
Materials - Overmoulded		
Overmould material:	PVC (black)	Polyamide (black)
Flammability rating:	UL94V-0	UL94V-0
Salt Mist:	EN60068-2-52 Test Kb Salt Mist (Cyclic) Marine Severity Level 1	EN60068-2-52 Test Kb Salt Mist (Cyclic) Marine Severity Level 1

Materials - Re-wireable and Panel Connectors

Connector body & locking ring	Polyester
Panel connector	Nylon 6
Flammability rating	UL94V-0
'O' rings	Silicone
Panel Gasket - round	Silicone
Panel Gasket - flange	Neoprene
RoHS	Compliant

Cables & POE	Cat 5e	Cat 6a	Cat 8
Conductors	24AWG (7/0.2mm) bare copper	26AWG (7/0.16mm) bare copper	26AWG (7/0.16mm) bare copper
Insulation	HD-PE	PE (Skin - Foam - Skin)	N/A
Pair	2 of the above cores twisted	2 of the above cores twisted	2 of the above cores twisted
Core	4 of the above cores	4 of the above cores	4 of the above cores
Screen	1 layer mylar and aluminium tape,	Aluminium & Polyester	Aluminium & Polyester
Braid	0.12mm tinned copper braid	Tinned Copper Braid	Tinned Copper Braid
Jacket	PUR (Black)	PVC (Black)	PVC (Black)
Op Temperature	-25°C to +85°C	-25°C to +75°C	-20°C to +60°C
Diameter	6.1mm nominal	6.0 mm nominal	6.0 mm nominal
Flame Test		FT4	
Electrical @ 20°C			
Characteristic:			
Impedance	100 Ω \pm 15 Ω @ 100MHz		
Capacitance	330pF/km		
Conductor Loop			
Resistance	29/ Ω 100m maximum	26 Ω /km	
Skew	45 nsec/100m @ 100MHz		
PoE Standard:	IEEE 802.3af (2 pair)	IEEE 802.3bt, Type 4 (4 pair) 4PoE++	IEEE 802.3bt, Type 4 (4 pair) 4PoE++
Power rating	12.95W	71W	71W
Current rating	350mA	960mA	1500mA
Voltage rating (DC)	44-57V	41.1V-57V	72V
Mechanical Characteristics			
Minimum Tensile Strength of Jacket (kg/mm ²)		1.05	
Maximum Length for Strip of Jacket (mm)		40	

Cable construction - CAT 5e

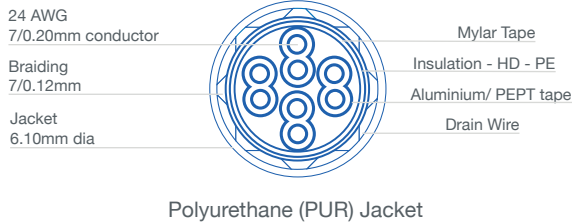

Cable construction - Cat 6a & Cat 8

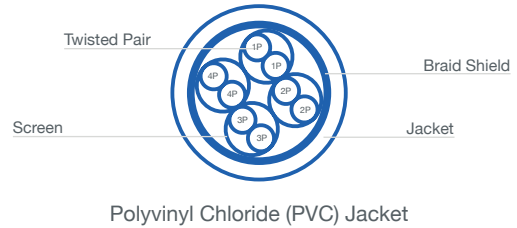

RJ45 Plug

Cat 5e & PoE

Cat 6a

Cat 8

Materials

Moulding	Polycarbonate	Polycarbonate	Polycarbonate
Shielding			Zinc Alloy
Flammability	UL94V-0	UL94V-0	UL94V-2
Contact material	Phosphor Bronze	Phosphor Bronze	Phosphor Bronze
Contact plating	50-micron gold	50-micron gold	50-micron gold
Operating Temperature	-40°C to +70°C	-40°C to +70°C	-20°C to +60°C
Mating cycles	1,000 cycles	1,000 cycles	1,200 cycles
RoHS	Compliant	Compliant	Compliant

Electrical

No. Conductors	8	8	8
Conductor types	24-28AWG, solid or multistranded	24-28AWG, solid or multistranded	26AWG, multistranded (pre-terminated)
Current rating	350mA	1500mA	1500mA
Voltage rating	37V AC, 57V DC	30V AC, 42V DC	72V DC
Contact resistance	10mΩ	10mΩ	20mΩ max.

Cat 8 (Keystone)

Materials

Coupler Shell	Zinc
Coupler Plating	Nickel
Moulding	PC
IDC Housing	PC
IDC Cap	PC + glass fibre
IDC Terminal	Tin plated Phosphor Bronze
Ground Contact	Stainless steel, Copper foil
Tie wrap	Nylon 6/6
Flammability	UL94V-2
Contact material	Phosphor Bronze
Contact plating	50-micron gold
Operating Temperature	-10°C to +60°C
Mating cycles - Jack	>750 cycles
Mating cycles - IDC	>20 terminations
RoHS	Compliant

Electrical

No. Conductors	8
Current rating	1.5A
Voltage rating	100V DC
Dielectric Withstand	1000V DC/AC @ 60hz for 1 minute
Contact resistance	10mΩ max.

RJ45 Coupler	Cat 5e	Cat 6a
Materials		
Coupler Shell	Copper Alloy	Copper Alloy
Coupler Plating	Nickel	Nickel
Moulding	PBT	PBT
Flammability	UL94V-0	UL94V-0
Contact material	Phosphor Bronze	Phosphor Bronze
Contact plating	50 micron gold	50 micron gold
Operating Temperature	-40°C to +70°C	0°C to +70°C
Mating cycles	1,000 cycles	1,000 cycles
RoHS	Compliant	Compliant
Electrical		
No. Conductors	8	8
Current rating	1.5A	1.5A
Voltage rating	30V AC, 42V DC	30V AC, 42V DC
Contact resistance	10mΩ max.	10mΩ max.

RJ45 PCB Connector	Cat 5e
Materials	
Coupler Shell	Copper Alloy
Coupler Plating	Nickel
Moulding	PBT
Flammability	UL94V-0
Contact material	Phosphor Bronze
Contact plating	50 micron gold
PC Plugs	Tin plated
Operating Temperature	-40°C to +70°C
Mating cycles	1,000 cycles
RoHS	Compliant
Electrical	
No. Conductors	8
Current rating	1.5A
Voltage rating	30V AC, 42V DC
Contact resistance	10mΩ max.