

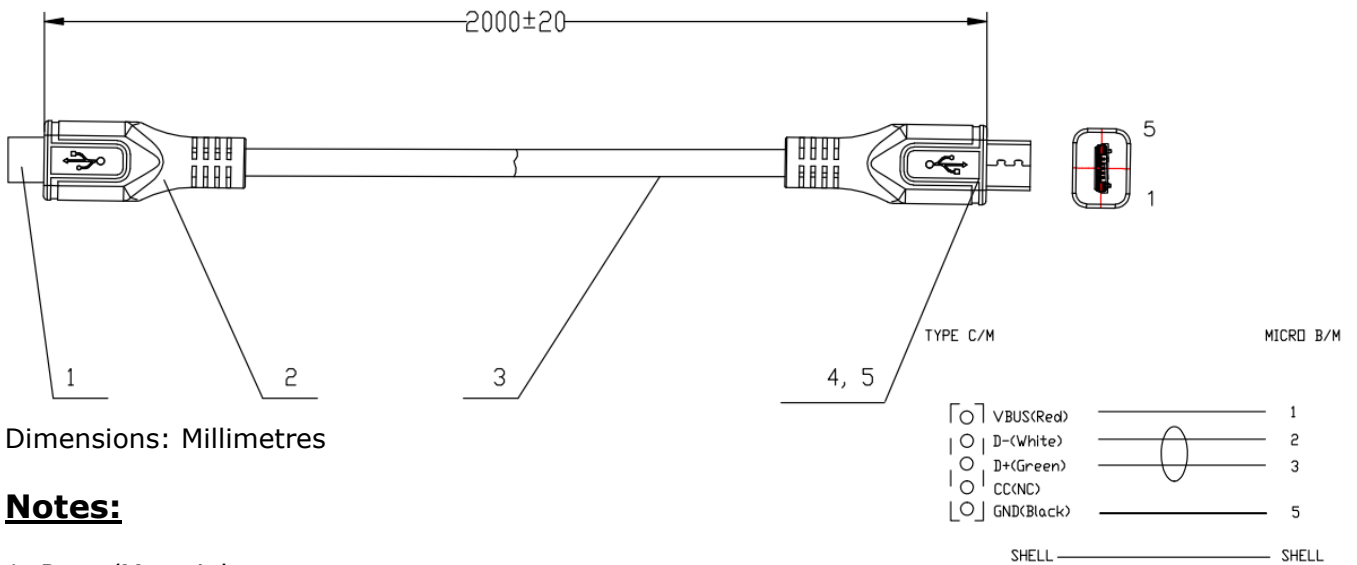

Specifications

Connectors	: Type C Male to Micro-B Male
USB Standard	: USB 2.0
Cable Colour	: Black
Length	: 2m
Compliances	: RoHS & REACH

Diagram



Notes:

1. Parts/Materials

- 1.1 No.1 USB Connector Type C Male
- 1.2 No.2 Mold: PVC Black
- 1.3 No.3 Cable: UL2725 2C*24AWG+1P*28AWG+ADB Ø4 BLACK
- 1.4 No.4 Mold: PVC Black
- 1.5 No.5 USB Connector Type Micro-B Male

Part Number Table

Description	Length	Part Number
USB 2.0 Cable, Type A to Micro-B, Black	1m	MB-A-1M-BK
	2m	MB-A-2M-BK
USB 2.0 Cable, Type C to Micro-B, Black	1m	MB-C-1M-BK
	2m	MB-C-2M-BK

Neither the whole nor any part of the information contained in, or the product described in this manual, may be adapted or reproduced in any material or electronic form without the prior written consent of the copyright holder. This product and its documentation are supplied on an as-is basis and no warranty as to their suitability for any particular purpose is either made or implied. Connective Peripherals Pte Ltd will not accept any claim for damages howsoever arising as a result of use or failure of this product. Your statutory rights are not affected. This product or any variant of it is not intended for use in any medical appliance, device or system in which the failure of the product might reasonably be expected to result in personal injury. This document provides preliminary information that may be subject to change without notice. No freedom to use patents or other intellectual property rights is implied by the publication of this document. Connective Peripherals Pte Ltd, 178 Paya Lebar Road, #07-03 Singapore 409030. Registered Number: 201617872E

Revision History

Revision	Changes	Date
1.0	Initial Release	16-02-2022

**Connective Peripherals Pte Ltd
178 Paya Lebar Road, #07-03 Singapore 409030
Tel.: +65 67430980 Fax: +65 68416071**

E-Mail (Support): support@connectiveperipherals.com Web: www.connectiveperipherals.com/products

Neither the whole nor any part of the information contained in, or the product described in this manual, may be adapted or reproduced in any material or electronic form without the prior written consent of the copyright holder. This product and its documentation are supplied on an as-is basis and no warranty as to their suitability for any particular purpose is either made or implied. Connective Peripherals Pte Ltd will not accept any claim for damages howsoever arising as a result of use or failure of this product. Your statutory rights are not affected. This product or any variant of it is not intended for use in any medical appliance, device or system in which the failure of the product might reasonably be expected to result in personal injury. This document provides preliminary information that may be subject to change without notice. No freedom to use patents or other intellectual property rights is implied by the publication of this document. Connective Peripherals Pte Ltd, 178 Paya Lebar Road, #07-03 Singapore 409030. Registered Number: 201617872E