

CAB-MSTB32/2XMC9/22/ 3,0M/C3/S - Interface cable



2906887

<https://www.phoenixcontact.com/us/products/2906887>

Please be informed that the data shown in this PDF document is generated from our online catalog. Please find the complete data in the user documentation. Our general terms of use for downloads are valid.

VIP 16-channel cable for use with Honeywell C300 universal I/O, 22 AWG, 3.0 m long



Your advantages

- Splitter cable for connecting two 8-channel VIP base modules to a Honeywell 16-channel IOTA board assembly
- #22 AWG halogen-free cable
- Locking flanges for securing cables to the modules and IOTA

Commercial data

Item number	2906887
Packing unit	1 pc
Note	Made to order (non-returnable)
Sales key	C480
Product key	CK8911
GTIN	4055626394466
Weight per piece (including packing)	939 g
Weight per piece (excluding packing)	939 g
Customs tariff number	85444290
Country of origin	MX

CAB-MSTB32/2XMC9/22/ 3,0M/C3/S - Interface cable



2906887

<https://www.phoenixcontact.com/us/products/2906887>

Technical data

Product properties

Product type	System cable
Product family	VIP I/O-Marshalling

Environmental and real-life conditions

Ambient conditions

Ambient temperature (operation)	-40 °C ... 90 °C (static)
Ambient temperature (storage/transport)	-40 °C ... 90 °C

Electrical properties

Operating voltage (AC/DC)	≤ 30 V AC/DC
Current (Per path)	≤ 2 A

Cable/line

Cable length	3 m
Number of positions	16
Shielded	yes
Conductor type	Assembled shielded round cable
Conductor structure signal line	7x
AWG signal line	22
Conductor cross section	16x 0.36 mm ²
External cable diameter	8.5 mm
Conductor material	Tin-plated Cu litz wires
Halogen-free	yes
Flame resistance	IEC 60332-1

Connection data

Field level

Connection method	pluggable
Number of connections	2
Number of positions	18
Pitch	3.81 mm

Controller level

Connection method	pluggable
Number of connections	1
Number of positions	32
Pitch	5.08 mm

CAB-MSTB32/2XMC9/22/ 3,0M/C3/S - Interface cable



2906887

<https://www.phoenixcontact.com/us/products/2906887>

Drawings

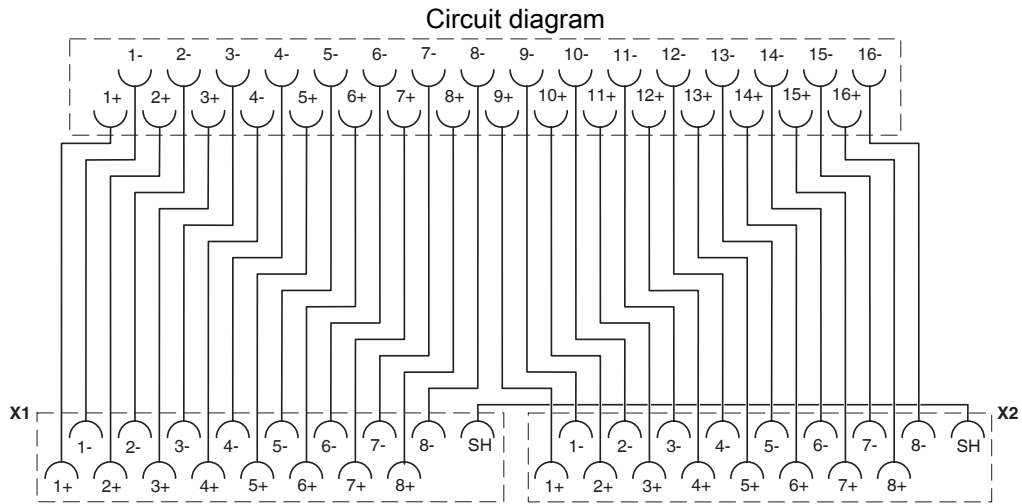

CAB-MSTB32/2XMC9/22/ 3,0M/C3/S - Interface cable



2906887

<https://www.phoenixcontact.com/us/products/2906887>

Approvals

To download certificates, visit the product detail page: <https://www.phoenixcontact.com/us/products/2906887>



EAC

Approval ID: RU*-DE.HB*35.B00385

CAB-MSTB32/2XMC9/22/ 3,0M/C3/S - Interface cable



2906887

<https://www.phoenixcontact.com/us/products/2906887>

Classifications

ECLASS

ECLASS-11.0	27242220
ECLASS-12.0	27242220
ECLASS-13.0	27242220

ETIM

ETIM 8.0	EC000237
----------	----------

UNSPSC

UNSPSC 21.0	26121600
-------------	----------

CAB-MSTB32/2XMC9/22/ 3,0M/C3/S - Interface cable



2906887

<https://www.phoenixcontact.com/us/products/2906887>

Accessories

VIP/S/MC/BASE 1-8/L/EX - Base module

2906596

<https://www.phoenixcontact.com/us/products/2906596>



8-channel VIP I/O marshalling base element for universal use. All connections as screw connection technology. With the COMBICON connector, compatible with the Honeywell C300 and RUSIO series. Marking for channels 1–8.

VIP/S/MC/BASE 9-16/L/EX - Base module

2906630

<https://www.phoenixcontact.com/us/products/2906630>



8-channel VIP I/O marshalling base element for universal use. All connections as screw connection technology. With the COMBICON connector, compatible with the Honeywell C300 and RUSIO series. Marking for channels 9–16.

CAB-MSTB32/2XMC9/22/ 3,0M/C3/S - Interface cable



2906887

<https://www.phoenixcontact.com/us/products/2906887>

VIP/S/MC/BASE 17-24/L/EX - Base module

2907024

<https://www.phoenixcontact.com/us/products/2907024>



8-channel VIP I/O marshalling base element for universal use. All connections as screw connection technology. With the COMBICON connector, compatible with the Honeywell C300 and RUSIO series. Marking for channels 17–24.

VIP/S/MC/BASE 25-32/L/EX - Base module

2907025

<https://www.phoenixcontact.com/us/products/2907025>



8-channel VIP I/O marshalling base element for universal use. All connections as screw connection technology. With the COMBICON connector, compatible with the Honeywell C300 and RUSIO series. Marking for channels 25–32.

CAB-MSTB32/2XMC9/22/ 3,0M/C3/S - Interface cable



2906887

<https://www.phoenixcontact.com/us/products/2906887>

VIP/S/MC/BASE 1-8/L/C/EX - Base module

2907186

<https://www.phoenixcontact.com/us/products/2907186>



8-channel VIP I/O marshalling base element for universal use. All connections as screw connection technology. With the COMBICON connector, compatible with the Honeywell C300 and RUSIO series. Marking for channels 1–8 and painting.

VIP/S/MC/BASE 9-16/L/C/EX - Base module

2907187

<https://www.phoenixcontact.com/us/products/2907187>



8-channel VIP I/O marshalling base element for universal use. All connections as screw connection technology. With the COMBICON connector, compatible with the Honeywell C300 and RUSIO series. Marking for channels 9–16 and painting.

CAB-MSTB32/2XMC9/22/ 3,0M/C3/S - Interface cable



2906887

<https://www.phoenixcontact.com/us/products/2906887>

VIP/S/MC/BASE 17-24/L/C/EX - Base module

2907209

<https://www.phoenixcontact.com/us/products/2907209>



8-channel VIP I/O marshalling base element for universal use. All connections as screw connection technology. With the COMBICON connector, compatible with the Honeywell C300 and RUSIO series. Marking for channels 17–24 and painting.

VIP/S/MC/BASE 25-32/L/C/EX - Base module

2907210

<https://www.phoenixcontact.com/us/products/2907210>



8-channel VIP I/O marshalling base element for universal use. All connections as screw connection technology. With the COMBICON connector, compatible with the Honeywell C300 and RUSIO series. Marking for channels 25–32 and painting.

Phoenix Contact 2023 © - all rights reserved
<https://www.phoenixcontact.com>

Phoenix Contact USA
586 Fulling Mill Road
Middletown, PA 17057, United States
(+717) 944-1300
info@phoenixcon.com