

# CES-STPG-GY-14 - Cable sleeve



0801686

<https://www.phoenixcontact.com/us/products/0801686>

Please be informed that the data shown in this PDF document is generated from our online catalog. Please find the complete data in the user documentation. Our general terms of use for downloads are valid.

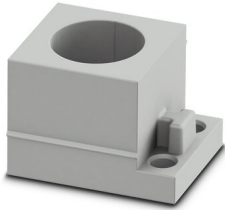

Cable sleeve, small, no. of conductors: 1, type: Round cable, slotted, external cable diameter: 1x 13 mm ... 14 mm, material: SEBS (halogen-free), color: gray, length: 29.5 mm, width: 19.5 mm, height: 17 mm

## Product description

Slotted cable sleeve

## Commercial data

Item number	0801686
Packing unit	1 pc
Minimum order quantity	10 pc
Sales key	BF67
Product key	BF7CCX
Catalog page	Page 680 (C-2-2019)
GTIN	4046356674904
Weight per piece (including packing)	5.5 g
Weight per piece (excluding packing)	5.5 g
Customs tariff number	40169997
Country of origin	PL

# CES-STPG-GY-14 - Cable sleeve

0801686

<https://www.phoenixcontact.com/us/products/0801686>

## Technical data

### Product properties

Product type	Cable sleeve
No. of conductors	1

### Dimensions

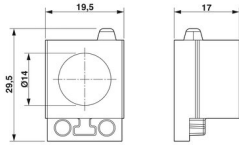
Dimensional drawing	
Width	19.5 mm
Height	17 mm
Length	29.5 mm

### Material specifications

Material	SEBS
Flammability rating according to UL 94	V0

### Cable/line

External cable diameter ( )	1x 13 mm ... 14 mm
-----------------------------	--------------------

### Characteristics

Seal size	small
Design, Format	Round cable
Design, Cable seal	slotted

### Environmental and real-life conditions

#### Ambient conditions

Degree of protection	IP54
Ambient temperature (operation)	-40 °C ... 80 °C (static)

# CES-STPG-GY-14 - Cable sleeve

0801686

<https://www.phoenixcontact.com/us/products/0801686>



## Drawings

Dimensional drawing

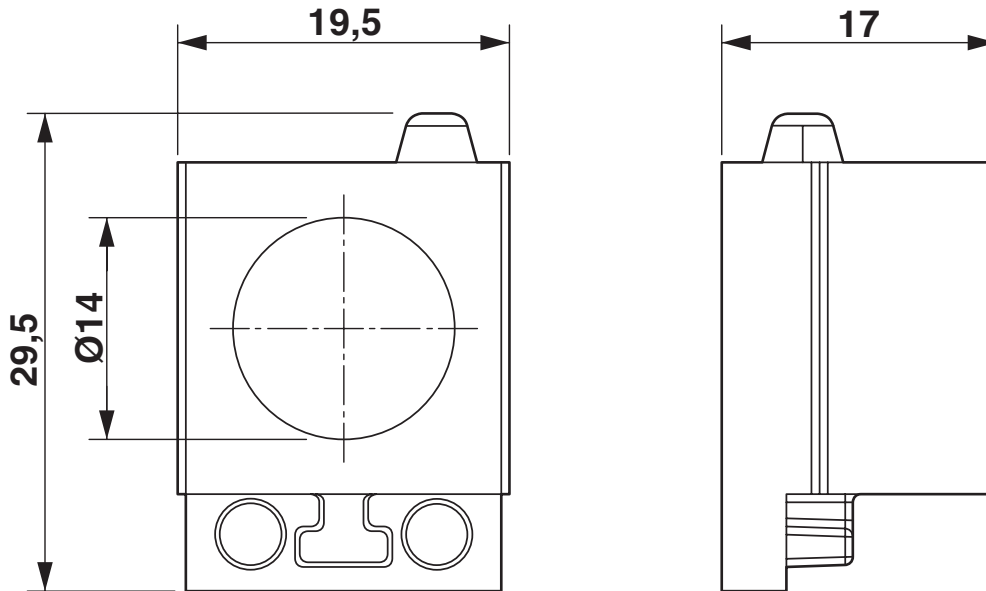

Dimensional drawing

# CES-STPG-GY-14 - Cable sleeve



0801686

<https://www.phoenixcontact.com/us/products/0801686>

## Approvals

To download certificates, visit the product detail page: <https://www.phoenixcontact.com/us/products/0801686>



**cUL Recognized**

Approval ID: NITW8.E255026



**UL Recognized**

Approval ID: NITW2.E255026

**DNV**

Approval ID: TAE00003VJ

**cULus Recognized**

# CES-STPG-GY-14 - Cable sleeve



0801686

<https://www.phoenixcontact.com/us/products/0801686>

## Classifications

### ECLASS

ECLASS-11.0	27144425
ECLASS-12.0	27144425
ECLASS-13.0	27144425

### ETIM

ETIM 8.0	EC000451
----------	----------

### UNSPSC

UNSPSC 21.0	39121400
-------------	----------

# CES-STPG-GY-14 - Cable sleeve



0801686

<https://www.phoenixcontact.com/us/products/0801686>

## Environmental product compliance

China RoHS	Environmentally friendly use period: unlimited = EFUP-e
	No hazardous substances above threshold values

# CES-STPG-GY-14 - Cable sleeve

0801686

<https://www.phoenixcontact.com/us/products/0801686>



## Accessories

### KDT-ST 14 - Filler plugs

3062032

<https://www.phoenixcontact.com/us/products/3062032>



Filler plugs, material: PA, length: 20 mm, diameter: 14 mm

---

### CES-B10-HFFS-PLBK - Sealing frame

0801663

<https://www.phoenixcontact.com/us/products/0801663>



Sealing frame, With locking latch, design: B10, Number of cable seals (small): 6, material: PA (halogen-free), color: black, length: 99.2 mm, width: 58 mm, height: 20 mm

# CES-STPG-GY-14 - Cable sleeve

0801686

<https://www.phoenixcontact.com/us/products/0801686>



## CES-B16-HFFS-PLBK - Sealing frame

0801662

<https://www.phoenixcontact.com/us/products/0801662>



Sealing frame, With locking latch, design: B16, Number of cable seals (small): 8, material: PA (halogen-free), color: black, length: 120 mm, width: 58 mm, height: 20 mm

---

## CES-B24-HFFS-PLBK - Sealing frame

0801661

<https://www.phoenixcontact.com/us/products/0801661>



Sealing frame, With locking latch, design: B24, Number of cable seals (small): 10, material: PA (halogen-free), color: black, length: 147 mm, width: 58 mm, height: 20 mm



# CES-STPG-GY-14 - Cable sleeve

0801686

<https://www.phoenixcontact.com/us/products/0801686>



## CES-B10-SFFS-PLBK - Sealing frame

0801660

<https://www.phoenixcontact.com/us/products/0801660>



Sealing frame, with screw locking, design: B10, Number of cable seals (small): 6, material: PA (halogen-free), color: black, length: 99.2 mm, width: 58 mm, height: 20 mm

---

## CES-B16-SFFS-PLBK - Sealing frame

0801659

<https://www.phoenixcontact.com/us/products/0801659>



Sealing frame, with screw locking, design: B16, Number of cable seals (small): 8, material: PA (halogen-free), color: black, length: 120 mm, width: 58 mm, height: 20 mm

# CES-STPG-GY-14 - Cable sleeve

0801686

<https://www.phoenixcontact.com/us/products/0801686>



## CES-B24-SFFS-PLBK - Sealing frame

0801658

<https://www.phoenixcontact.com/us/products/0801658>



Sealing frame, with screw locking, design: B24, Number of cable seals (small): 10, material: PA (halogen-free), color: black, length: 147 mm, width: 58 mm, height: 20 mm

---

Phoenix Contact 2023 © - all rights reserved

<https://www.phoenixcontact.com>

Phoenix Contact USA  
586 Fulling Mill Road  
Middletown, PA 17057, United States  
(+717) 944-1300  
[info@phoenixcon.com](mailto:info@phoenixcon.com)