

DO NOT SCALE FROM THIS PRINT

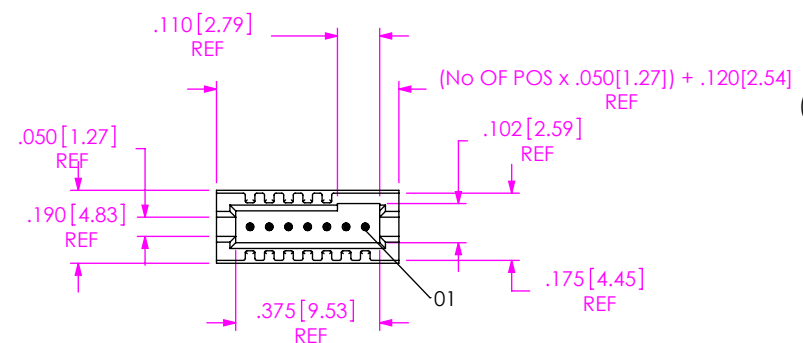
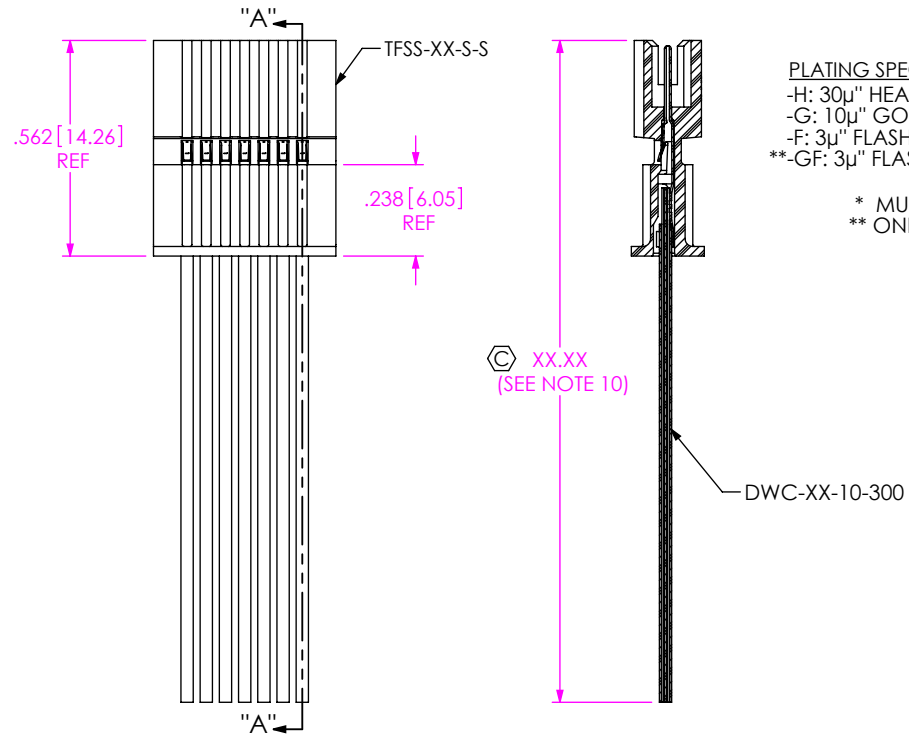

FIG 1
-S: SINGLE END
(TFSSX-07-28-XX-XX.XX-S SHOWN)



SECTION "A"-"A"

NOTES:

1. Ⓢ REPRESENTS A CRITICAL DIMENSION.
2. MINIMUM PULLOUT FORCE: 3 LBS [13.3 N].
3. CONTACT MUST BE INSERTED UNTIL RETENTION FEATURE LOCKS INTO PLACE.
4. Ⓢ ALL FINISHED GOODS ARE TO BE ELECTRICAL TESTED INCLUDING HI-POT TEST AT 300 V. AFTER FINAL ELECTRICAL TEST, MARK EACH ASSEMBLY PER INSTRUCTIONS REFERENCED IN CO-(AD-ID)-WI-3092-M.
5. TINNED COPPER WIRE IS ROHS COMPLIANT.
6. NOTE DELETED.
7. END OF DISCRETE WIRE MUST BE IN THE RANGE AFTER CRIMP.
8. REFER TO CRIMP SPECIFICATIONS PRINT FOR CRIMP AND STRIP DIMENSIONS, TOLERANCES, TOOLING AND ITS REQUIREMENTS..
9. END OF DISCRETE WIRE MUST BE IN RANGE AFTER CRIMP.
10. FOR LENGTHS LESS THAN 12 IN, TOLERANCE SHALL BE ±.125[3.18]. FOR OTHER LENGTHS, TOLERANCES SHALL BE ±2%.
11. DOES NOT APPLY TO FEP CABLE.
12. SINGLE ENDED ASSEMBLIES USING THE FEP OPTION ARE FOR CRIMP APPLICATIONS ONLY.
13. SEE PACKAGING MANUAL FOR PACKAGING DETAILS.

TFSSX-XX-XXX-XX-XX.XX-X-XXX

- FEP CABLE OPTION
-T: FEP
(LEAVE BLANK FOR STANDARD PVC INSULATION (SEE NOTE 12))
- No OF POSITIONS
-02 THRU -50
- WIRE GAUGE (AWG)
-28
-30
- COLOR CODE
LEAVE BLANK FOR ALL BLACK WIRE, C: COLOR CODED WIRE (SEE TABLE 2; SHEET 2; SEE NOTE 11)
- NXX OPTION (END 2)
(ONLY AVAILABLE WITH -D, -T, OR -TR)
-NUS: NOTCH UP, STRAIGHT (PIN 1 TO PIN 1)
-NDS: NOTCH DOWN, STRAIGHT (PIN 1 TO PIN 7)
- END OPTION
-S: SINGLE END
* -D: DOUBLE END (MUST CHOOSE FROM -NXX OPTIONS)
* -T: TRANSFER END (SEE SHEET 2 AND 4) (MUST CHOOSE FROM -NXX OPTIONS)
-TR: TRANSFER END W/ RETENTION LATCH (SEE SHEET 2 AND 4) (MUST CHOOSE FROM -NXX OPTIONS)
- ASSEMBLED LENGTH
SPECIFY IN INCHES
(SINGLE END: 03.00 INCH [76.2mm] MINIMUM, DOUBLE END: 03.25 INCH [82.6mm] MINIMUM)
- PLATING SPECIFICATION
-H: 30μ" HEAVY GOLD IN CONTACT AREA, 3μ" FLASH GOLD ON TAIL
-G: 10μ" GOLD IN CONTACT AREA, 3μ" FLASH GOLD ON TAIL
-F: 3μ" FLASH GOLD IN CONTACT AREA, 3μ" FLASH GOLD ON TAIL
**-GF: 3μ" FLASH GOLD IN CONTACT AREA, 3μ" FLASH GOLD ON TAIL

* MUST CHOOSE FROM -NXX OPTIONS
** ONLY AVAILABLE TO EXISTING CUSTOMERS, SEE -F PLATING

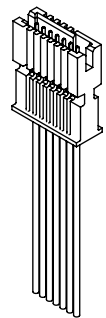

SERIES	WIRE GAUGE	CABLE	TERMINAL	CONTACT*
TFSS	28	DWC-28-10-300	T-1M44-2830-XX	C-203-2830-XX
TFSS	30	DWC-30-10-300	T-1M44-2830-XX	C-203-2830-XX
TFSSST	28	DWCT-28-01-TC	T-1M44-2830-XX	C-203-2830-XX
TFSSST	30	DWCT-30-01-TC	T-1M44-2830-XX	C-203-2830-XX

* CONTACTS USED FOR TRANSFER END OPTION ONLY

<p>UNLESS OTHERWISE SPECIFIED, DIMENSIONS ARE IN INCHES. TOLERANCES ARE:</p> <p>DECIMALS ANGLES</p> <p>.XX: ±.01 [0.3] 2°</p> <p>.XXX: ±.005 [0.13]</p> <p>.XXXX: ±.0020 [0.051]</p>	<p>PROPRIETARY NOTE</p> <p>THIS DOCUMENT CONTAINS CONFIDENTIAL AND PROPRIETARY INFORMATION AND ALL DESIGN, MANUFACTURING, REPRODUCTION, USE, PATENT RIGHTS AND SALES RIGHTS ARE EXPRESSLY RESERVED BY SAMTEC, INC. THIS DOCUMENT SHALL NOT BE DISCLOSED, IN WHOLE OR PART, TO ANY UNAUTHORIZED PERSON OR ENTITY NOR REPRODUCED, TRANSFERRED OR INCORPORATED IN ANY OTHER PROJECT IN ANY MANNER WITHOUT THE EXPRESS WRITTEN CONSENT OF SAMTEC, INC.</p>	<p>520 PARK EAST BLVD, NEW ALBANY, IN 47150 PHONE: 812-944-6733 FAX: 812-948-5047 e-Mail: info@SAMTEC.com code 55322</p>

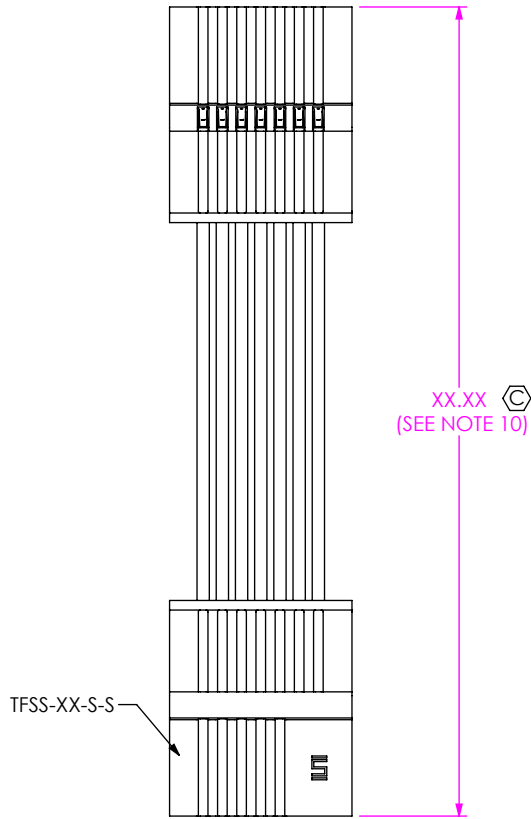

FIG 2
*-D: DOUBLE END
(TFSSX-07-28-X-XX.XX-D-NUS SHOWN)
(SAME AS FIG. 1, UNLESS OTHERWISE STATED)

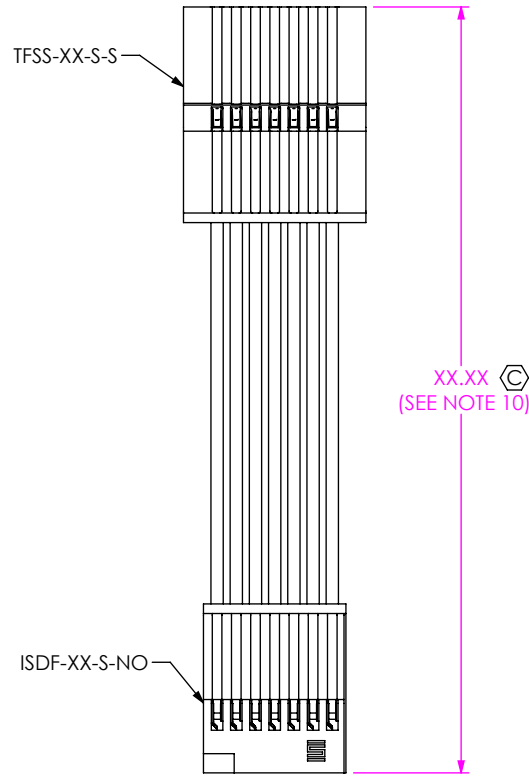

FIG 3
*-T: TRANSFER END
(TFSSX-07-28-X-XX.XX-T-NUS SHOWN)
(SAME AS FIG. 1, UNLESS OTHERWISE STATED)

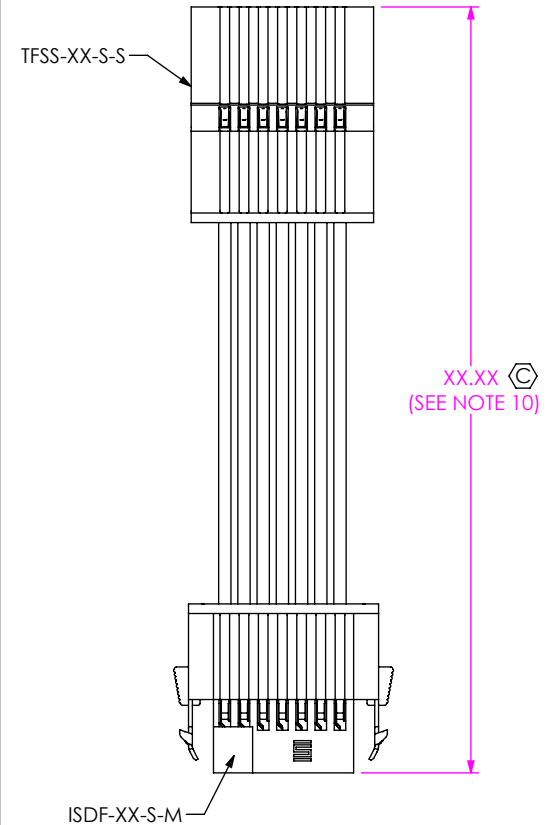

FIG 4
*-TR: TRANSFER END WITH RETENTION LATCH
(TFSSX-07-28-X-XX.XX-TR-NUS SHOWN)
(SAME AS FIG. 1, UNLESS OTHERWISE STATED)
(ONLY AVAILABLE IN -02 THRU -30 POS)

TABLE 2
TFSS COLOR CODED WIRE SEQUENCE

PIN #	COLOR									
	BROWN	RED	ORANGE	YELLOW	GREEN	VIOLET	GRAY	WHITE	BLACK	BLUE
	DWC-XX01-300	DWC-XX02-300	DWC-XX03-300	DWC-XX04-300	DWC-XX05-300	DWC-XX07-300	DWC-XX08-300	DWC-XX09-300	DWC-XX10-300	DWC-XX13-300
1	2	3	4	5	6	7	8	9	10	
11	12	13	14	15	16	17	18	19	20	
21	22	23	24	25	26	27	28	29	30	
31	32	33	34	35	36	37	38	39	40	
41	42	43	44	45	46	47	48	49	50	

F:\DWG\MISC\MKTG\TFSSX-XX-XXX-XX-XX.XX-X-XXX-MKT.SLDDRW

PROPRIETARY NOTE
THIS DOCUMENT CONTAINS CONFIDENTIAL AND PROPRIETARY INFORMATION AND ALL DESIGN, MANUFACTURING, REPRODUCTION, USE, PATENT RIGHTS AND SALES RIGHTS ARE EXPRESSLY RESERVED BY SAMTEC, INC. THIS DOCUMENT SHALL NOT BE DISCLOSED, IN WHOLE OR PART, TO ANY UNAUTHORIZED PERSON OR ENTITY NOR REPRODUCED, TRANSFERRED OR INCORPORATED IN ANY OTHER PROJECT IN ANY MANNER WITHOUT THE EXPRESS WRITTEN CONSENT OF SAMTEC, INC.

DO NOT SCALE DRAWING

SHEET SCALE: 2:1



520 PARK EAST BLVD, NEW ALBANY, IN 47150
PHONE: 812-944-6733 FAX: 812-948-5047
e-Mail info@SAMTEC.com code 55322

DESCRIPTION:
.050[1.27] SOCKET DISCRETE CABLE ASSEMBLY

DWG. NO.
TFSSX-XX-XXX-XX-XX.XX-X-XXX

BY: GAYNOR 6/13/2008 SHEET 2 OF 4

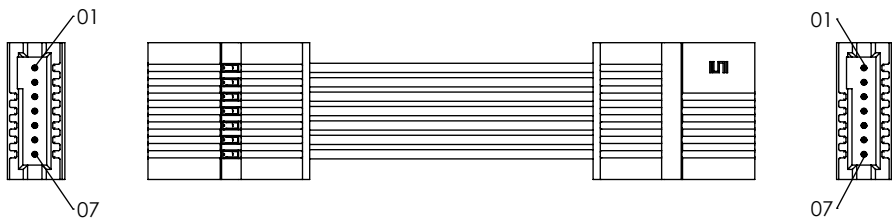

-NUS
(END 2 NOTCH UP, CABLE STRAIGHT)
(PIN 1 TO PIN 1)

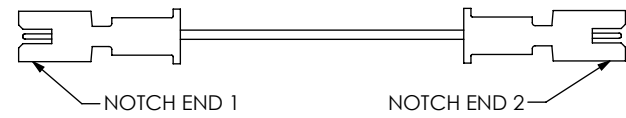
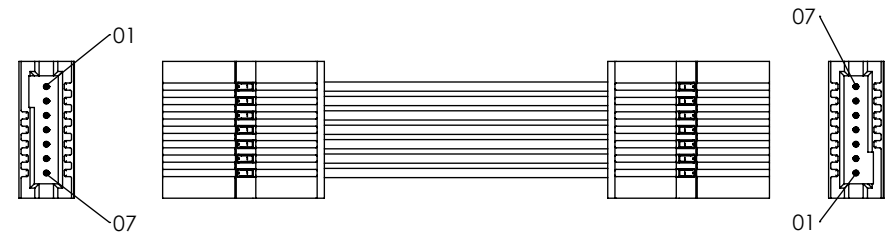

-NDS
(END 2 NOTCH DOWN, CABLE STRAIGHT)
(PIN 1 TO PIN 7)

PROPRIETARY NOTE
THIS DOCUMENT CONTAINS CONFIDENTIAL AND PROPRIETARY INFORMATION AND ALL DESIGN, MANUFACTURING, REPRODUCTION, USE, PATENT RIGHTS AND SALES RIGHTS ARE EXPRESSLY RESERVED BY SAMTEC, INC. THIS DOCUMENT SHALL NOT BE DISCLOSED, IN WHOLE OR PART, TO ANY UNAUTHORIZED PERSON OR ENTITY NOR REPRODUCED, TRANSFERRED OR INCORPORATED IN ANY OTHER PROJECT IN ANY MANNER WITHOUT THE EXPRESS WRITTEN CONSENT OF SAMTEC, INC.

DO NOT SCALE DRAWING

SHEET SCALE: 1.75:1



520 PARK EAST BLVD, NEW ALBANY, IN 47150
PHONE: 812-944-6733 FAX: 812-948-5047
e-Mail info@SAMTEC.com code 55322

DESCRIPTION:
.050[1.27] SOCKET DISCRETE CABLE ASSEMBLY

DWG. NO.
TFSSX-XX-XXX-XX-XX.XX-X-XXX

BY: GAYNOR 6/13/2008 SHEET 3 OF 4

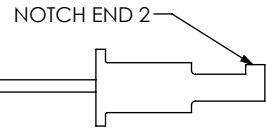
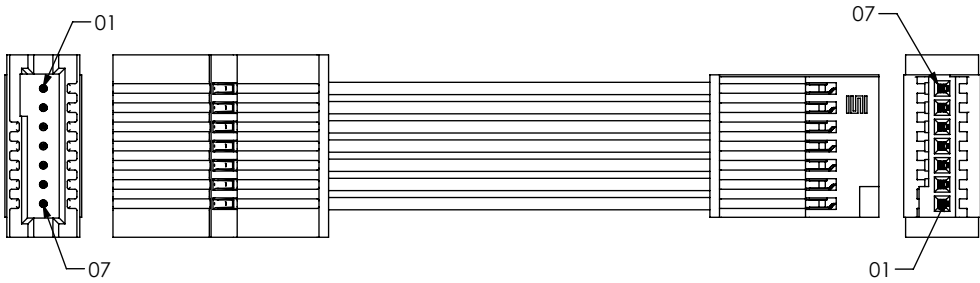

T-NUS
(END 2 NOTCH UP, CABLE STRAIGHT)
(PIN 1 TO PIN 7)

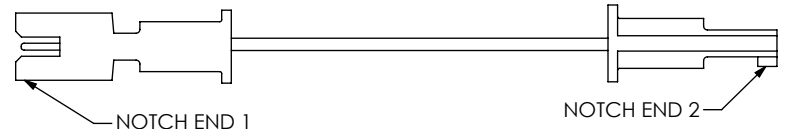
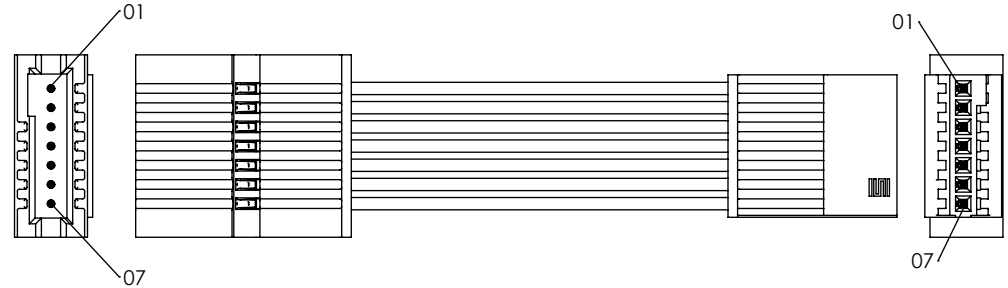

T-NDS
(END 2 NOTCH DOWN, CABLE STRAIGHT)
(PIN 1 TO PIN 1)

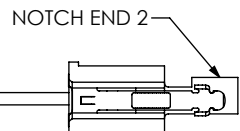
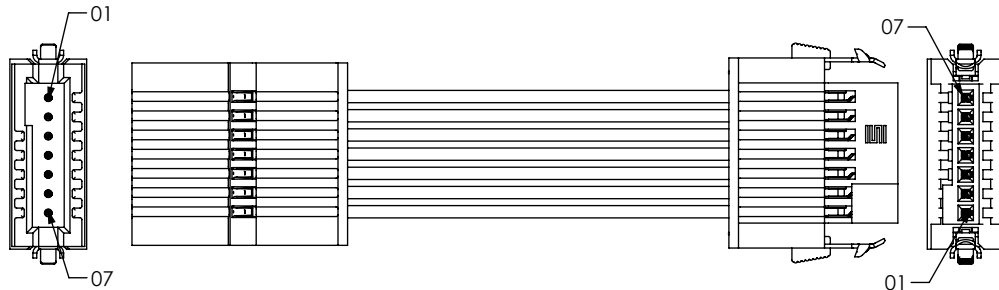

TR-NUS
(END 2 NOTCH UP, CABLE STRAIGHT)
(PIN 1 TO PIN 7)

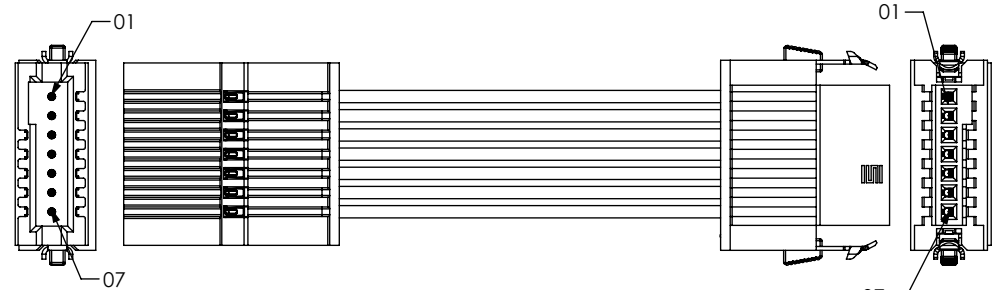

TR-NDS
(END 2 NOTCH DOWN, CABLE STRAIGHT)
(PIN 1 TO PIN 1)

PROPRIETARY NOTE
THIS DOCUMENT CONTAINS CONFIDENTIAL AND PROPRIETARY INFORMATION AND ALL DESIGN, MANUFACTURING, REPRODUCTION, USE, PATENT RIGHTS AND SALES RIGHTS ARE EXPRESSLY RESERVED BY SAMTEC, INC. THIS DOCUMENT SHALL NOT BE DISCLOSED, IN WHOLE OR PART, TO ANY UNAUTHORIZED PERSON OR ENTITY NOR REPRODUCED, TRANSFERRED OR INCORPORATED IN ANY OTHER PROJECT IN ANY MANNER WITHOUT THE EXPRESS WRITTEN CONSENT OF SAMTEC, INC.

DO NOT SCALE DRAWING

SHEET SCALE: 2:1



520 PARK EAST BLVD, NEW ALBANY, IN 47150
PHONE: 812-944-6733 FAX: 812-948-5047
e-Mail: info@SAMTEC.com code 55322

DESCRIPTION:
.050[1.27] SOCKET DISCRETE CABLE ASSEMBLY

DWG. NO.
TFSSX-XX-XXX-XX-XX.XX-X-XXX

BY: GAYNOR 6/13/2008 SHEET 4 OF 4