

CABLIN[®]- UY

Low mating height (Height = 0.76 mm), Narrow pitch (0.35 mm pitch),
Right angle vertical mating type micro-coaxial cable connector

Product Specifications:

Mating type	Right angle vertical	
Board Pitch (mm)	0.35	
Wiping Length (mm)	0.1	
Mated size (mm)	Height	0.76 +/- 0.06
	Width	Formula: 2.15 + (0.35 * ?p)
	Depth	3.10
Pin Counts	Range	Up to 25p
	Available	5, 10p

Applicable Cable Size:

Maximum O.D. (mm)	0.35
Micro-Coaxial for Signal (AWG)	45 ohm: #40 or smaller 50 ohm: #42 or smaller
Twinax (AWG)	-
Discrete (AWG)	#36 or smaller

Applicable Standards (Reference Only):

USB4 Gen4 (40Gbps/Lane PAM3)
USB4 Gen3/ Thunderbolt 4 (20 Gbps/lane)
eDP HBR 3 (8.1 Gbps)



* Please inquire for pin counts not listed or outside of the pin count range.

Small, low height design, suitable for narrow spaces

Connector mated size

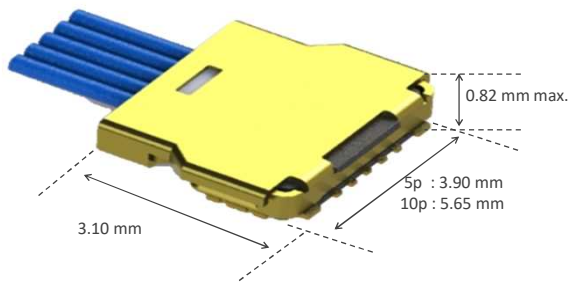

Size comparison image of 5p plug with a one-cent coin

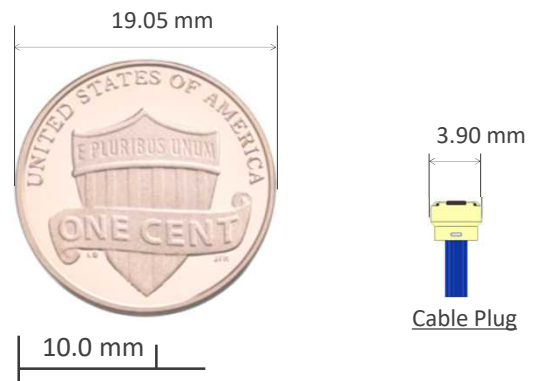

Excellent differential SI performance(32Gbps/Lane)

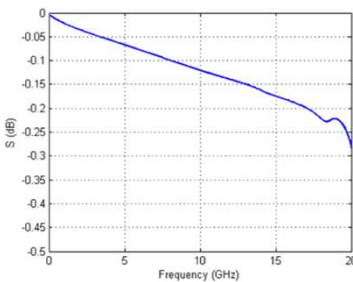

Insertion Loss

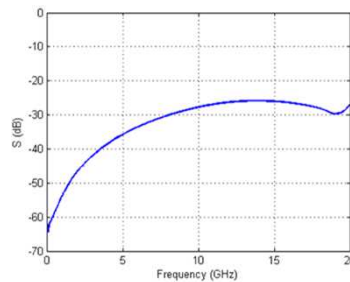

Return Loss

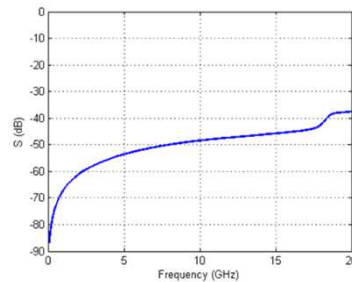

Near-End Crosstalk

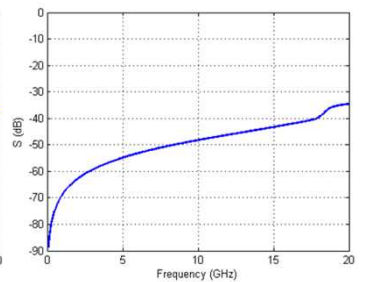

Far-End Crosstalk

Simulation Software : ANSYS Electronics Desktop 2021 R1
Simulation Model : Cable plug mated to a receptacle
Frequency Range : 0.1 – 20 GHz

Data Format : Touchstone Data (.s8p)
Reference Impedance : 90 Ohms differential
Pin Assignment GSSGSSG

Plug design able to go through small hinge after cable termination

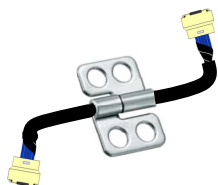

Simulation results (5P):
No need to bend the cable

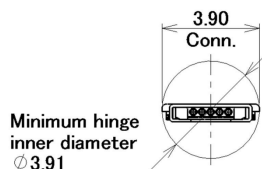

Simulation results (more than 5P): Minimum hinge inner diameter without bonding (mm)

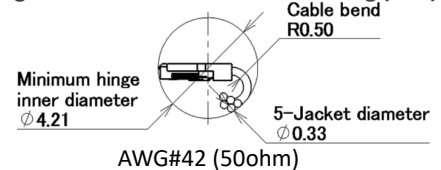
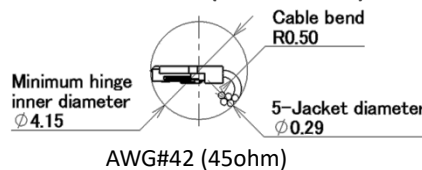

Simulation results (more than 5P): Minimum hinge inner diameter with bonding (mm)

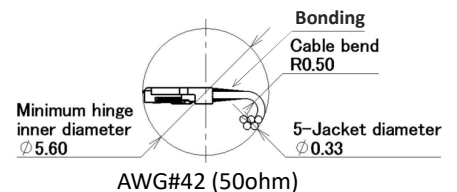
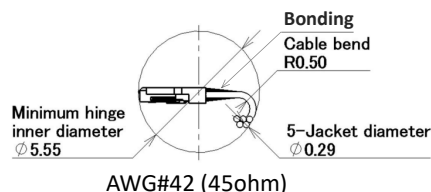

Component Parts Details

Component Parts

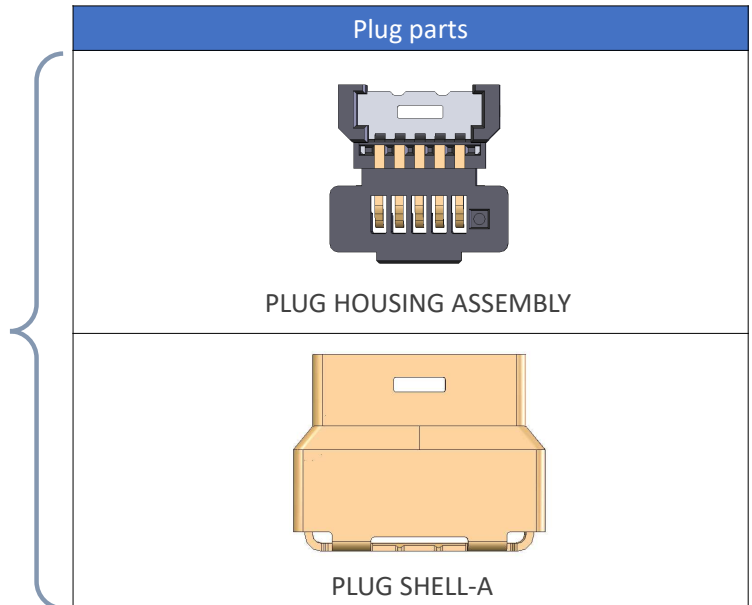
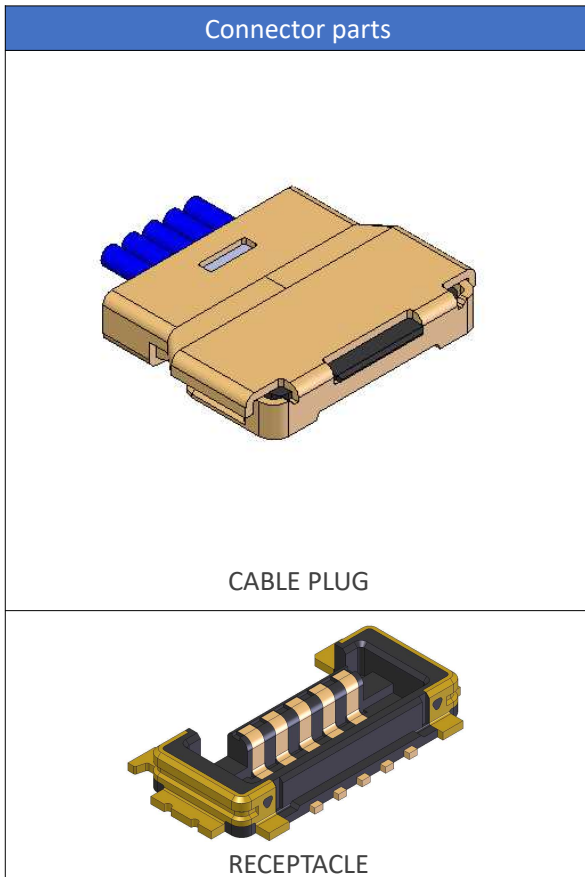

Plug for Cable Assembly

Recommended P/N		20857-0**T-01	
PART NO.	Pos.	A	B
20857-005T-01	5	3.90	1.40
20857-010T-01	10	5.65	3.15

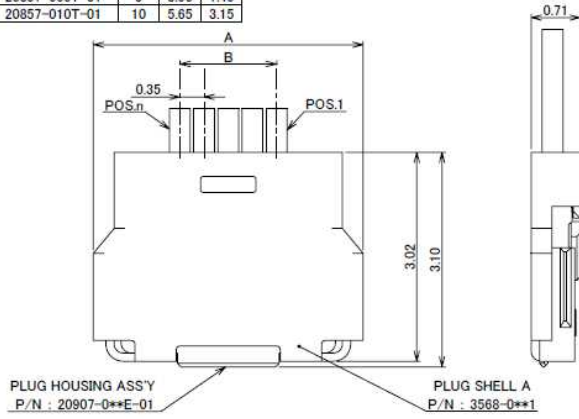

PART COMBINATION TABLE			
PLUG CABLE ASS'Y	HOUSING ASS'Y	PLUG SHELL A	RECEPTACLE
20857-005T-01	20907-005E-01	3568-0051	20854-005E-02
20857-010T-01	20907-010E-01	3568-0101	20854-010E-02

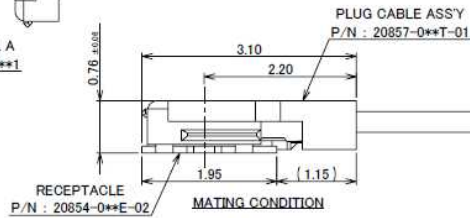
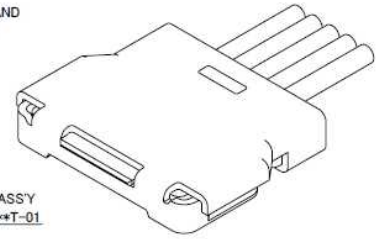
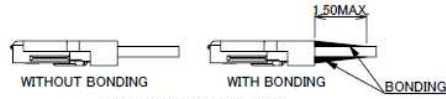

NO.	DESCRIPTION	MATERIAL	FINISH, REMARKS
4	SHELL B	SUS	Au 0.02 μm MIN. OVER Ni 1.00 μm MIN.
3	SHELL A	PHOSPHOR BRONZE	ALL OVER Ni 1.00 μm MIN. CONTACT PART Au 0.02 μm MIN. SOLDERING PART Au 0.02 μm MIN.
2	CONTACT	CORSON ALLOY	ALL OVER Ni 1.00 μm MIN. CONTACT PART Au 0.02 μm MIN. SOLDERING PART Au 0.02 μm MIN.
1	HOUSING	LCP	UL94V-0, BLACK

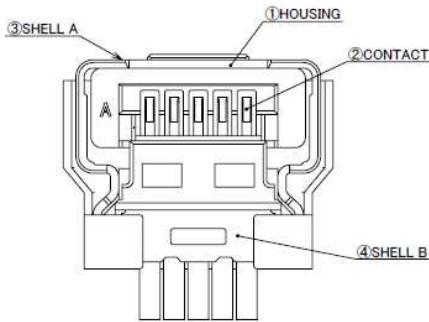

Rev.4

PART NO.	Pos.	C
20857-005T-01	5	1.40
20857-010T-01	10	3.15

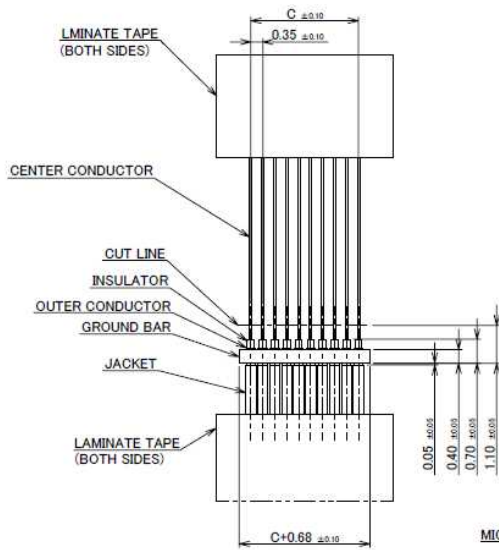

RECOMMENDED MICRO COAX CABLE DIM.

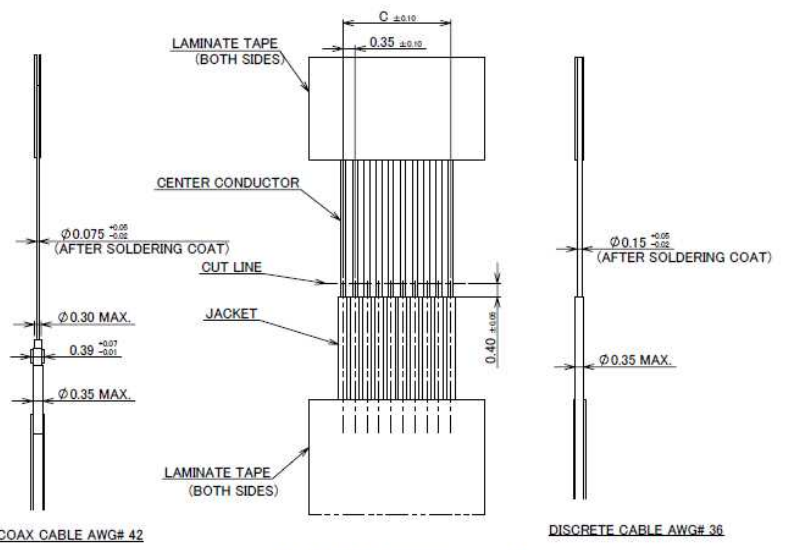

RECOMMENDED DISCRETE CABLE DIM.

Rev.4

Plug Housing Assembly

Recommended P/N		20907-0**E-01									
PART NO.	Pos.	A	B	C	D	E	F	G	H	J	
20907-005E-01	5	3.10	1.98	1.47	1.86	2.18	2.30	2.80	1.80	2.40	
20907-010E-01	10	4.85	3.73	3.22	3.61	3.93	4.05	4.55	3.55	4.15	

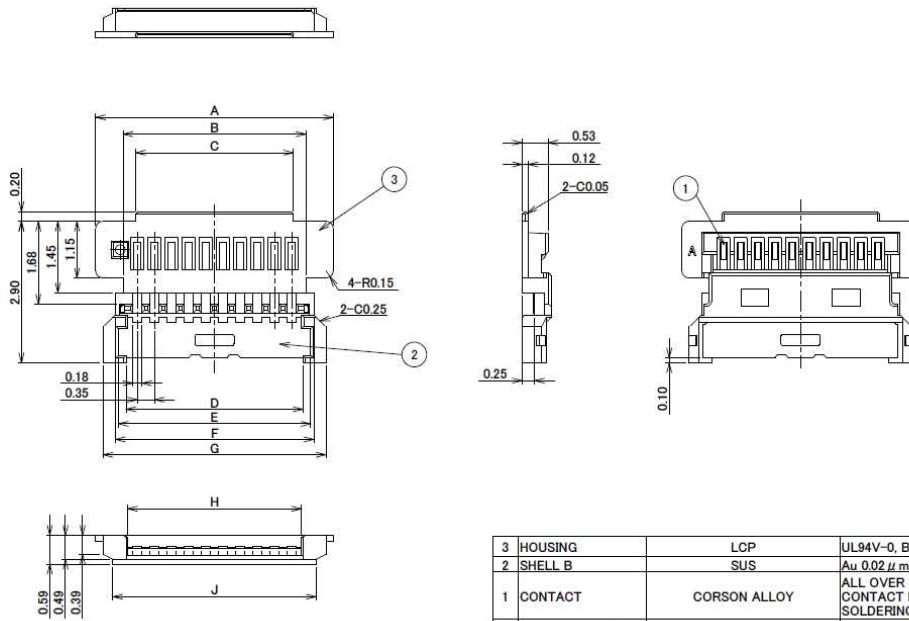

3	HOUSING	LCP	UL94V-0, BLACK
2	SHELL B	SUS	Au 0.02 μ m MIN. OVER Ni 1.00 μ m MIN.
1	CONTACT	CORSON ALLOY	ALL OVER Ni 1.00 μ m MIN. CONTACT PART Au 0.02 μ m MIN. SOLDERING PART Au 0.02 μ m MIN.
NO.	DESCRIPTION	MATERIAL	FINISH, REMARKS

Rev.1

Plug Shell-A

Recommended P/N		3568-0**1			
PART NO.	Pos.	A	B	C	D
3568-0051	5	3.34	3.90	3.46	2.80
3568-0101	10	5.09	5.65	5.21	4.55

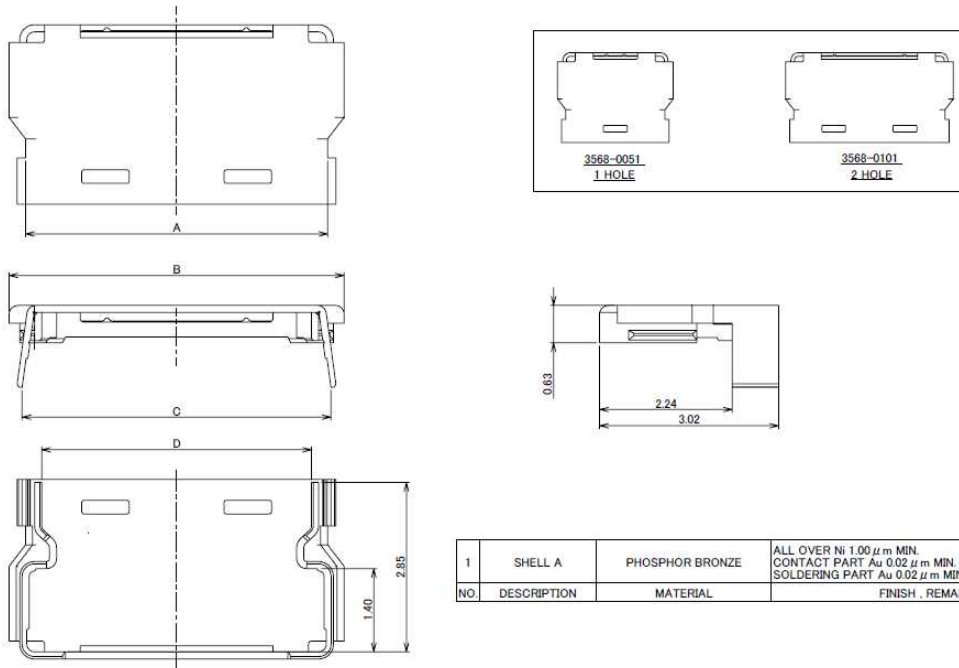

1	SHELL A	PHOSPHOR BRONZE	ALL OVER Ni 1.00 μ m MIN. CONTACT PART Au 0.02 μ m MIN. SOLDERING PART Au 0.02 μ m MIN.
NO.	DESCRIPTION	MATERIAL	FINISH, REMARKS

Rev.2

Receptacle Assembly

Recommended P/N 20854-0**E-02

PART NO.	Pos.	A	B	C	D	E	F	G	H	J
20854-005E-02	5	3.70	3.30	3.18	2.28	1.40	2.28	2.88	3.90	2.90
20854-010E-02	10	5.45	5.05	4.93	4.03	3.15	4.03	4.63	5.65	4.65

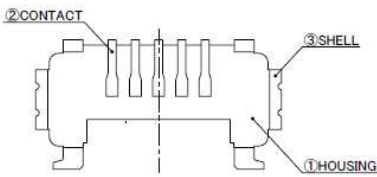
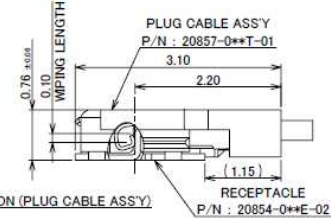
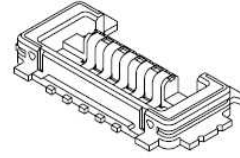
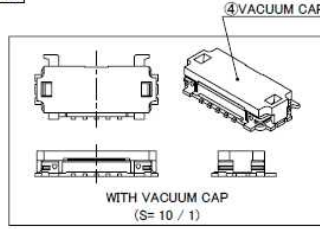
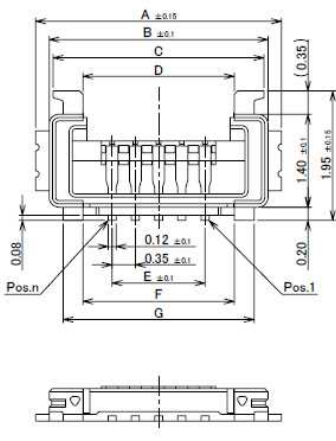

NO.	DESCRIPTION	MATERIAL	FINISH, REMARKS
4	VACUUM CAP	LCP	UL94V-0, BLACK
3	SHELL	PHOSPHOR BRONZE	ALL OVER Ni 1.00 μm MIN. CONTACT PART: Au 0.01 μm MIN. SOLDERING PART: Au 0.01 μm MIN.
2	CONTACT	PHOSPHOR BRONZE	ALL OVER Ni 1.00 μm MIN. CONTACT PART: Au 0.05 μm MIN. SOLDERING PART: Au 0.03 μm MIN.
1	HOUSING	LCP	UL94V-0, BLACK

NOTE.
1. COPLANARITY: 0.08mm MAX.

Rev.5

PART NO.	Pos.	K	L	M	N	P	Q	R	S	T	U	V	W	X	Y	Z	AA	AB	AC
20854-005E-02	5	3.90	3.48	3.12	2.16	1.40	2.16	3.18	3.28	3.90	3.48	3.36	3.12	2.26	1.40	2.26	3.18	7.50	6.20
20854-010E-02	10	5.65	5.23	4.87	3.91	3.15	3.91	4.93	5.03	5.65	5.23	5.11	4.87	4.01	3.15	4.01	4.93	9.25	7.95

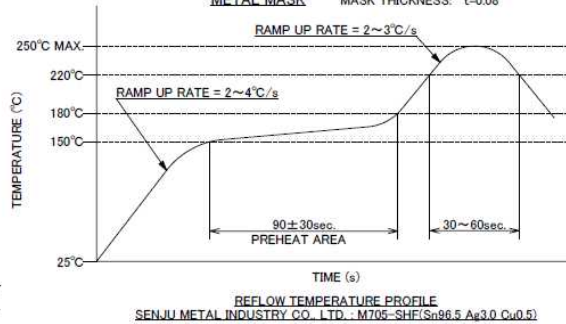
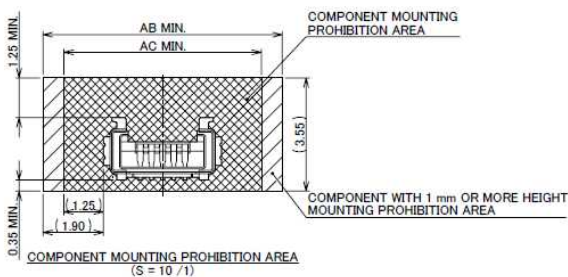
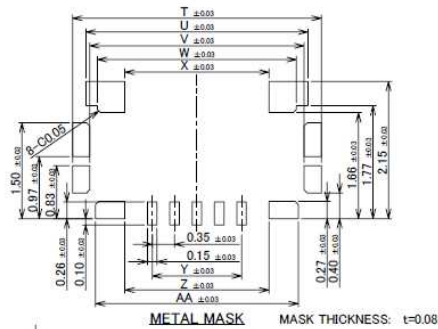
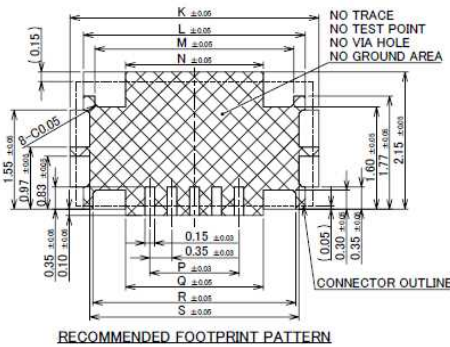

REFLOW TEMPERATURE PROFILE
SENJU METAL INDUSTRY CO., LTD. : M705-SHF(Sn96.5 Ag3.0 Cu0.5)

NOTE.
2. SOLDER RESIST SHALL BE APPLIED TO PREVENT SHORT CIRCUITS WHEN PLACING SIGNAL LINES ON GROUND AREA.

Rev.5

ITEMS	SPECIFICATION
APPLICABLE CABLE	MICRO COAX : AWG# 42 DISCRETE : AWG# 36
RATING VOLTAGE	60V AC (PER CONTACT PIN)
RATING AMPERAGE (FOR CONTACT)	0.35 AC/DC[AWG# 42] 0.5 AC/DC[AWG# 36]
OPERATING TEMPERATURE	233~358K(-40°C~+85°C)
OPERATING HUMIDITY	85% MAX.(NON-CONDENSING)
CONTACT RESISTANCE	INITIAL : 700mohm MAX.(AWG# 42) / AFTER TEST : Δ R 40mohm MAX. 275mohm MAX.(AWG# 36)
GROUND SHELL RESISTANCE	INITIAL : 60mohm MAX. / AFTER TEST : Δ R 40mohm MAX.
INSULATION RESISTANCE	INITIAL : 500Mohm MIN. / AFTER TEST : 100Mohm MIN.
DIELECTRIC WITHSTANDING VOLTAGE	AC200V 1min
DURABILITY	30 CYCLES
MATING FORCE (INITIAL / AFTER TEST)	5P : INITIAL: 30N MAX. / AFTER TEST: 30N MAX. 10P : INITIAL: 30N MAX. / AFTER TEST: 30N MAX.
UNMATING FORCE (INITIAL / AFTER TEST)	5P : INITIAL: 5N MIN. / AFTER TEST: 3N MIN. 10P : INITIAL: 5N MIN. / AFTER TEST: 3N MIN.
CABLE RETENTION FORCE	5Pin : 2.45N MIN. 10Pin : 4.9N MIN.
PRODUCT SPECIFICATION	PRS-2634
TEST REPORT	TR-19084
INSTRUCTION MANUAL	HIM-18037
ASSEMBLY MANUAL	ASM-18002
APPEARANCE CRITERIA No.	QLS-A***

Rev.4

Board to Board



High-Density



Autolocking FPC/FFC

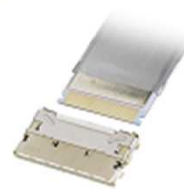

High-Density



FPC/FFC



Micro-Coaxial / Discrete Cable



High-Speed



RF



High-Frequency



Optical Module



High-Speed



Power



High-Power



I/O (Input/Output)



Quick charge



Effector



Custom Connectors Available

Inquiry

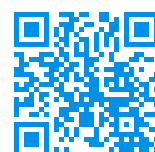

I-PEX, MHF, CABLINE, NOVASTACK, EVAFLEX, MINIFLEX, ISH, IARPB, IASLP, ESTORQ, ISFIT, i-Fit and ZenShield are registered trademarks of I-PEX Inc. Please note that the contents in the catalog might be changed without prior notification. I-PEX Inc. assumes no responsibility for any inaccuracies or obligation to update information on these documents. Please be sure to read and understand the latest "Precautions for Use" and "Instruction Manual" before you use our products. We shall not be responsible for any defects, damages or troubles in case you use our products without following the precautions for use. Please feel free to contact our sales representatives when you use our products for any applications that require very high reliability and safety, or that relate to human life (ex. nuclear power control, aerospace, transportation, medical equipment, safety equipment etc.).

Contact your sales representative or more detailed information.

www.i-pex.com



I-PEX

© I-PEX Inc. 2022
All rights reserved.