

Features

- Ideal for surface mounted application.
- Fast Switching Speed.
- For General Purpose Switching Applications.
- Epitaxial Planar Diode.
- Lead-free parts meet RoHS requirements.

Mechanical data

- Epoxy : UL94-V0 rated flame retardant
- Case : Molded plastic, SOT-23
- Terminals :Plated terminals, solderable per MIL-STD-750, Method 2026
- Mounting Position : Any

Package

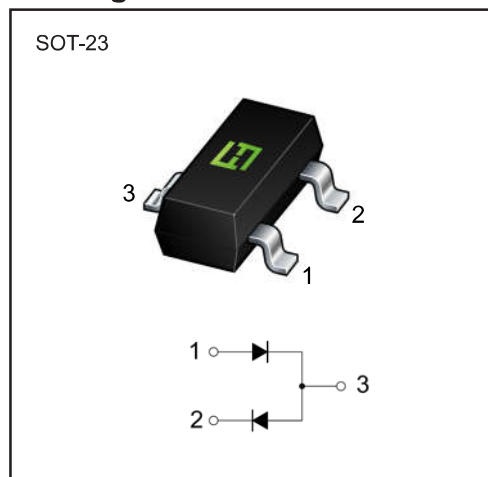

Maximum Ratings @Ta=25°C

Parameter	Symbol	Limit	Unit
Repetitive peak reverse voltage	V_{RRM}	600	V
DC blocking voltage	V_{DC}		
Average rectified output current	$I_{F(AV)}$	500	mA
Non-Repetitive Peak Forward Surge Current	I_{FSM}	8.0	A
Junction temperature	T_J	-55~+150	°C
Storage temperature range	T_{STG}	-55~+150	°C

ELECTRICAL CHARACTERISTICS (Ta=25°C unless otherwise specified)

Parameter	Symbol	Test conditions	Min	Typ	Max	Unit
Reverse breakdown voltage	$V_{(BR)}$	$I_R=100\mu A$	600			V
Reverse voltage leakage current	I_R	$V_R=600V$			10	μA
Forward voltage	V_F	$I_F=300mA$			1.3	V
Diode capacitance	C_T	$V_R=0V, f=1MHz$		5		pF
Reveres recovery time	t_{rr}	$I_F=I_R=10mA, I_{tr}=0.1 \times I_R$			80	ns

Rating and characteristic curves

Forward Characteristics

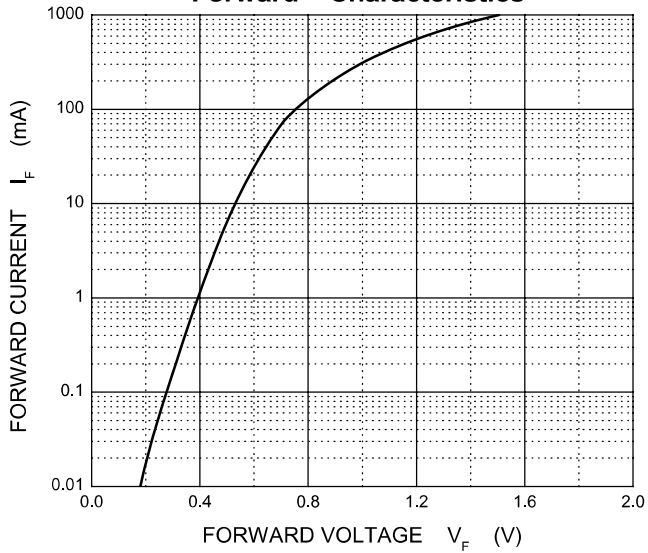

Reverse Characteristics

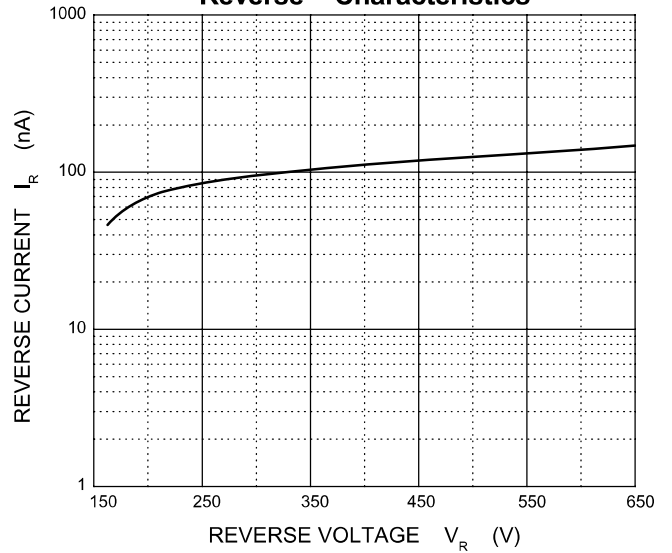

Capacitance Characteristics

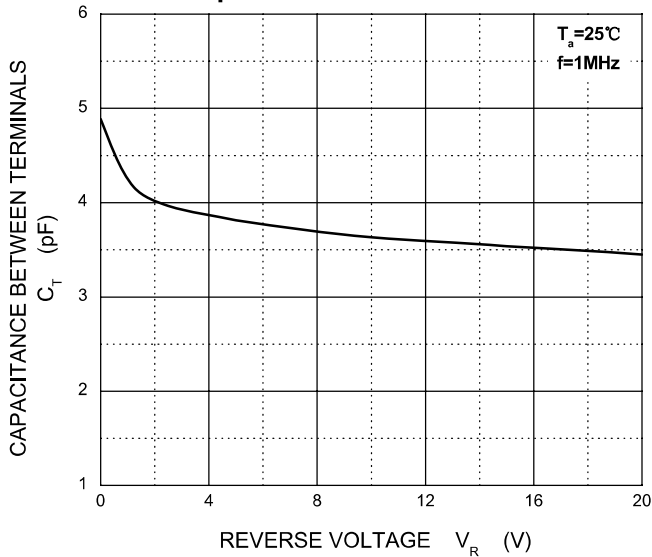

Power Derating Curve

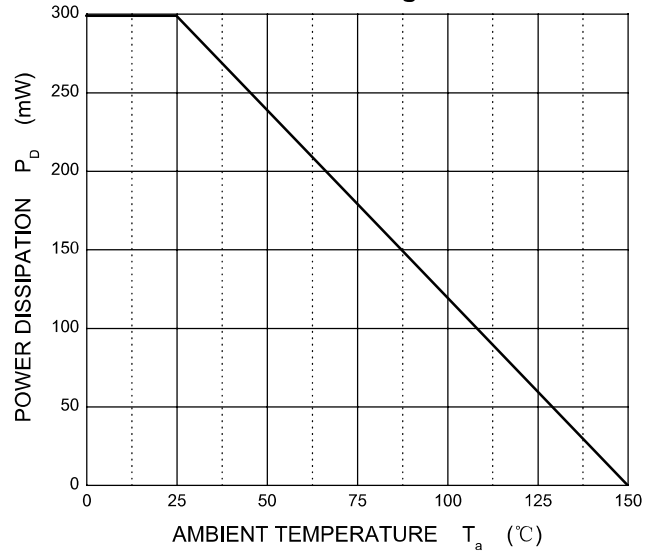

Pinning information

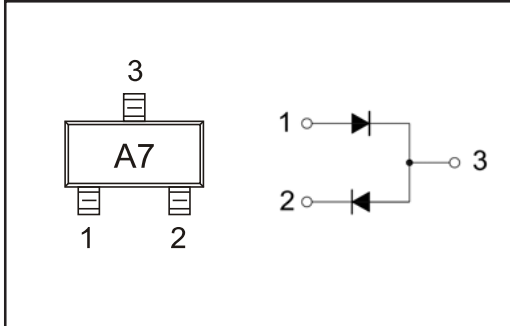

Package Outline

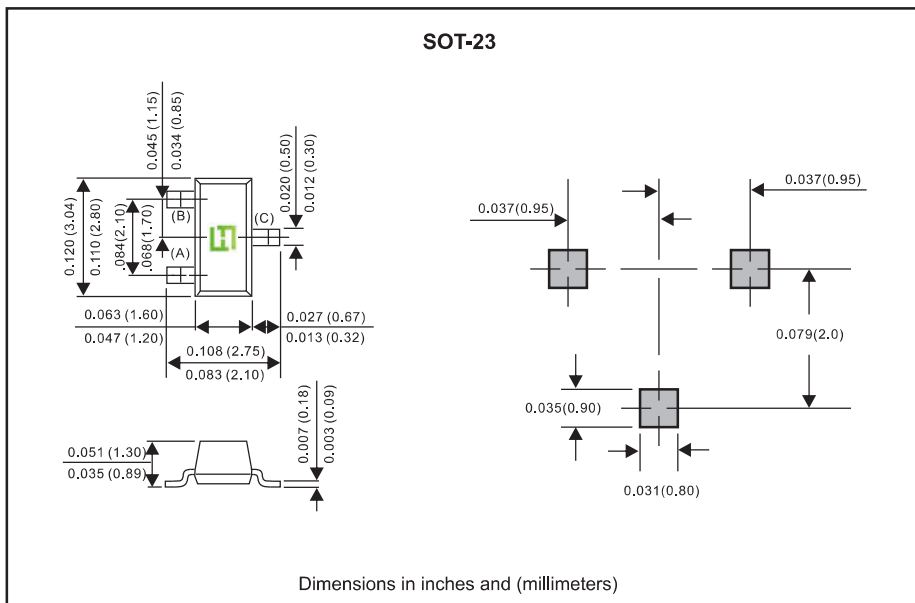

Suggested thermal profiles for soldering processes

- 1.Storage environment: Temperature=5°C~40°C Humidity=55%±25%
- 2.Reflow soldering of surface-mount devices

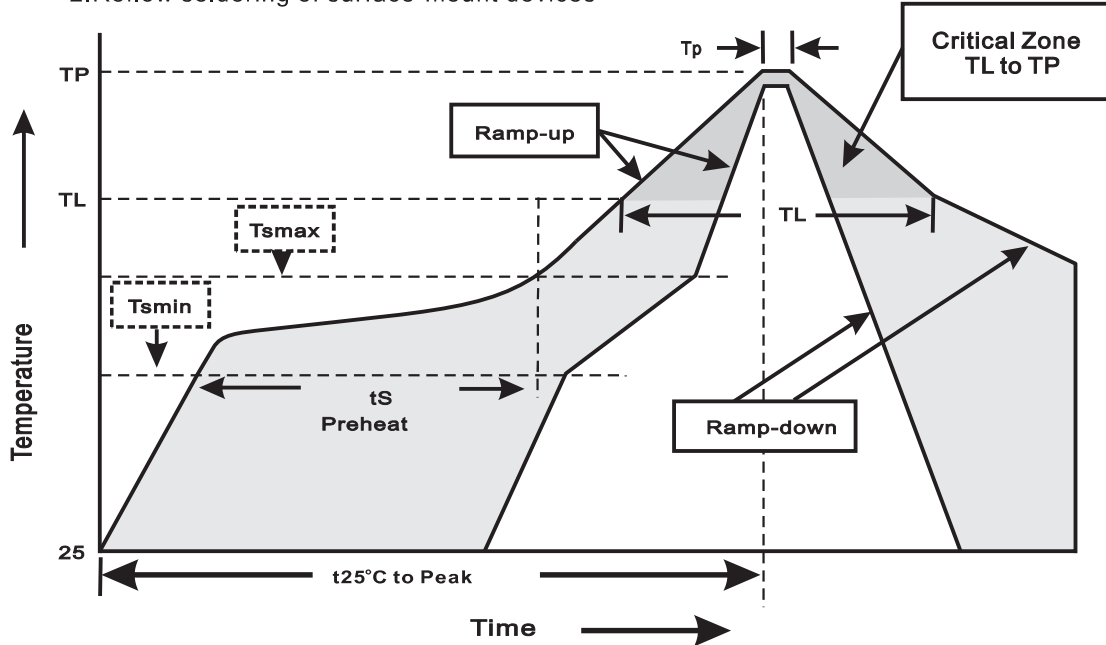

3.Reflow soldering

Profile Feature	Soldering Condition
Average ramp-up rate(T _L to T _P)	<3°C/sec
Preheat -Temperature Min(T _{smin}) -Temperature Max(T _{smax}) -Time(min to max)(t _s)	150°C 200°C 60~120sec
T _{smax} to T _L -Ramp-upRate	<3°C/sec
Time maintained above: -Temperature(T _L) -Time(t _L)	217°C 60~260sec
Peak Temperature(T _P)	255°C-0/+5°C
Time within 5°C of actual Peak Temperature(t _P)	10~30sec
Ramp-down Rate	<6°C/sec
Time 25°C to Peak Temperature	<6minutes